

UC-NRLF

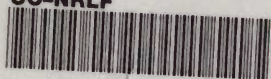

B 3 151 546

GURLEY'S MANUAL

AMERICAN
ENGINEERS' AND SURVEYORS'
INSTRUMENTS.

FORTY-SECOND EDITION

LIBRARY
OF THE
UNIVERSITY OF CALIFORNIA.

GIFT OF

L. E. Hurley

Class

S

Gurley form

A MANUAL

OF THE PRINCIPAL

INSTRUMENTS

USED IN

AMERICAN ENGINEERING
AND SURVEYING

MANUFACTURED BY

W. & L. E. GURLEY

TROY, N. Y., U. S. A.

FORTY-SECOND EDITION

TROY, N. Y.
PUBLISHED BY W. & L. E. GURLEY
AUGUST, 1908



PRICE, 50 CENTS

TA 581
G 8
1908

W. & L. E. Gurley
Entered, according to Act of Congress, in the Year 1908

By W. & L. E. GURLEY

In the Office of the Librarian of Congress, at Washington

THE
MATTHEWS-NORTHROP
WORKS
BUFFALO CLEVELAND AND NEW YORK





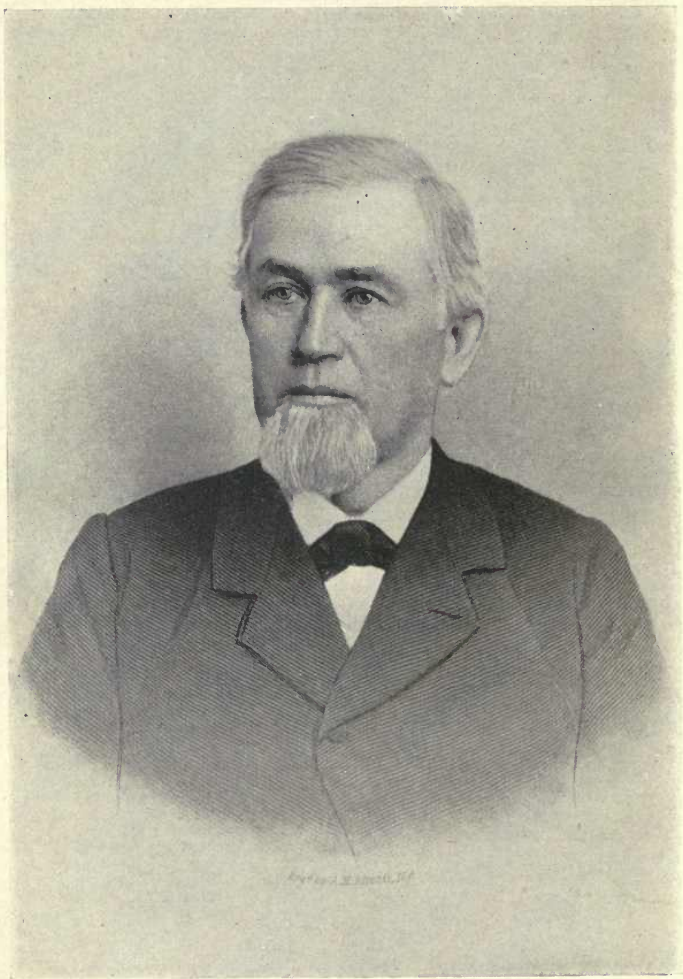

William Gurley



Leov E Gurley



W. & L. E. GURLEY'S INSTRUMENT MANUFACTORY.—ESTABLISHED 1845

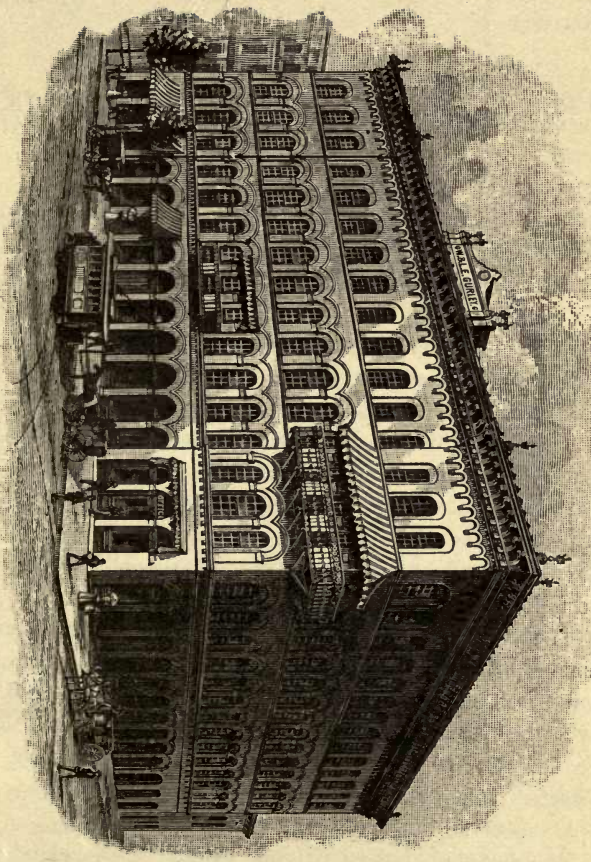

1845-1908

PREFACE TO THE FORTY-SECOND EDITION

MORE THAN SIXTY YEARS AGO the manufacture of Civil Engineers' and Surveyors' instruments in this city was begun by Jonas H. Phelps and William Gurley. Mr. Phelps retiring some years later, William Gurley formed with his brother, Lewis E. Gurley, the firm of W. & L. E. Gurley, and under this name the business has since been conducted.

The first edition of GURLEY'S MANUAL, a book of seventy pages, was published in 1855, and was the first really practical treatise on the use and adjustment of Civil Engineers' and Surveyors' instruments. The revised and enlarged MANUAL is used as a text-book in many schools and colleges, and is freely quoted in technical publications.

The capacity of our factory has been increased as the demand for such instruments has grown, until we are the most extensive manufacturers of Civil Engineers' and Surveyors' instruments in the world. We have recently added two departments to our factory, and now manufacture thermometers of high grade, and also physical and scientific apparatus of all kinds.

We are glad to have all our manufactures judged upon their merits, and invite the most critical examination.

W. & L. E. GURLEY,

TROY, N. Y., U. S. A.

TRANSIT-INSTRUMENTS



THE AMERICAN TRANSIT is by far the most important instrument used in engineering. The essential parts, which may be seen in the cuts, are the telescope with its axis, the standards, the circular plates with their attachments, the sockets upon which the plates revolve, the leveling-head, and the tripod upon which the whole instrument stands.

The telescope is secured in an axis having its bearings fitted in the standards, allowing the telescope to transit. The different parts of the telescope are shown in the cut on page 7.

The objective is an achromatic lens placed at the end of a slide having two bearings, one at the end of the outer tube, the other in the ring, C C, which is suspended within the tube by four screws, only two of which are shown in the cut.

The eyepiece is composed of four lenses which are called respectively the eye, the field, the amplifying, and the object lens, the whole forming a compound microscope focusing on the cross-wires attached to the ring, B B.

In all our transits, with the exception of the Explorers', Reconnaissance, and Builders' Transits, both the objective and eyepiece are moved out or in by pinions working in racks attached to their sides, and are thus adjusted to proper focus. In the instruments named, the eyepiece is focused by a spiral movement.

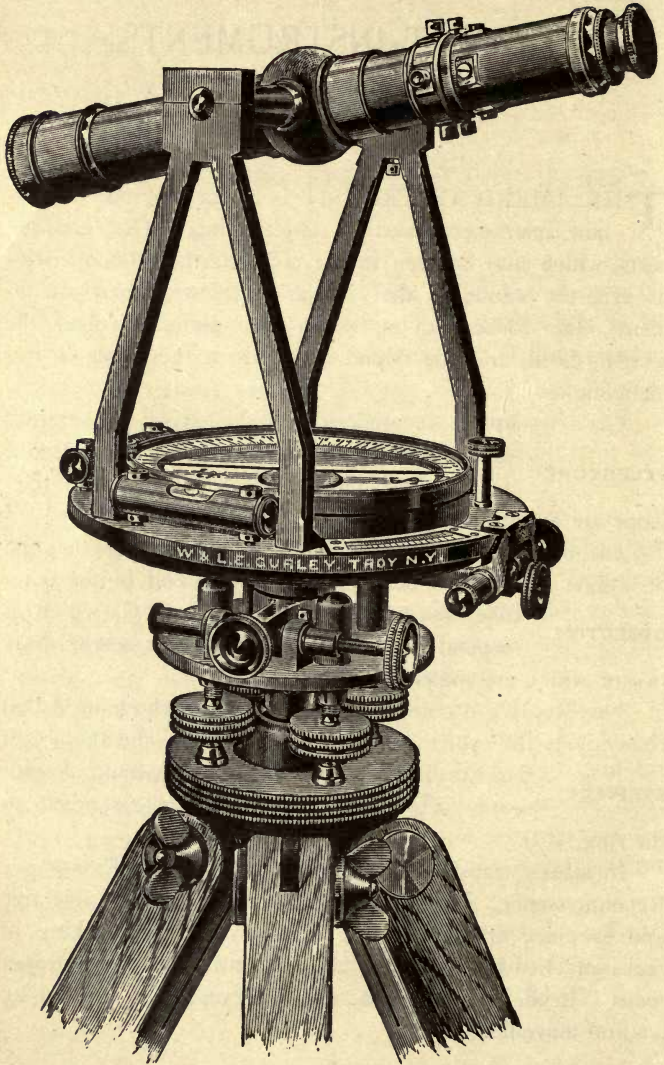
**NO. 12**

Engineers' Transit, two verniers to limb, with 5-inch needle, plain telescope, and tripod.
Price, as shown, \$150.00.

Sometimes an eyepiece with but two lenses is used, but while this gives **INVERTING EYEPIECE** more light it presents an inverted image of the object observed, and it is not often desired by American engineers.

The objective, receiving the rays of light from all points of a visible object, **VISION AIDED BY TELESCOPE** converges them to a focus at the cross-wires, and there forms a minute, inverted image, which may be seen by placing a piece of ground glass at that point to receive it.

The eyepiece magnifies this image, restores it to its natural position and conveys it to the eye.

The visual angle which the image subtends is as many times greater than **MAGNIFYING POWER** that which would be formed without the aid of the telescope as the number which expresses its magnifying power is greater than unity. Thus, a telescope which magnifies twenty times increases the visual angle in the same proportion, and therefore diminishes the apparent distance of the object twenty times. In other words, it will show an object two hundred feet distant with the same distinctness as if it were only ten feet distant from the naked eye.

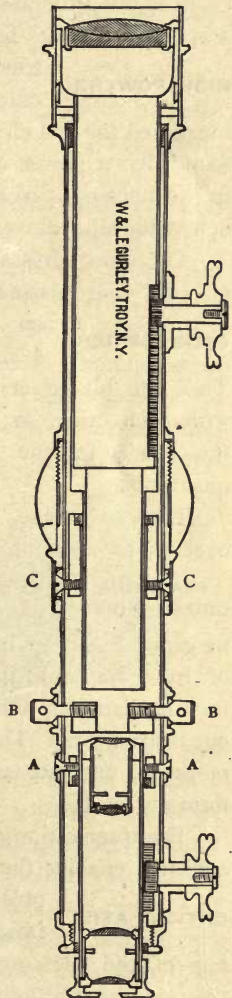

It is often supposed that the greater the power of a telescope the better; but, beyond a certain limit, this is not true. As only a given amount of light can enter the objective, the more the object is magnified the less clear and bright will it appear. We have found that a power of from twenty to twenty-four diameters in the telescopes of transits gives the best results, and is sufficient for all ordinary practice.

The cross-wires are two wires of very fine platinum, mounted on the face of a metal ring.

They are placed at right angles with each other, so as to divide the space in the center into quadrants.

The advantage of platinum over spider-web for the cross-wires of telescopes has long been conceded, but the difficulty of procuring it of sufficient fineness has prevented its general use. We are successfully drawing platinum wires of from one eight-thousandth to one fifty-thousandth of an inch in diameter, and are using them in the telescopes of all our instruments. These wires are opaque and unaffected by moisture, and are universally preferred to the spider-web formerly used.

The intersection of the wires forms a point which, when adjusted, enables the surveyor to fix the telescope upon an object with the greatest precision. The imaginary line passing through the optical axis of the telescope is called the line of collimation, and the process of bringing the intersection of the wires into the

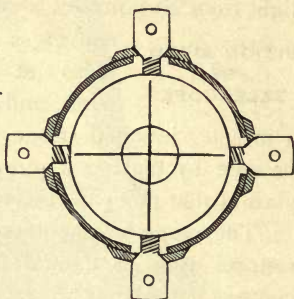

optical axis is called the adjustment of the line of collimation. This is described on pages 22 to 24.

The sectional view of the telescope on page 7 shows two movable rings, one at A A, the other at C C, which are used respectively in centering the eyepiece and in the adjustment of the objective slide.

The centering of the eyepiece is effected after the wires have been adjusted, by moving the ring, by means of the screws shown on the outside of the tube, until the intersection of the wires is brought into the center of the field of view.

The adjustment of the objective slide, which is described on page 25, keeps the line of collimation in adjustment through the whole range of the slide. This is peculiar to our telescopes, is always made in the process of manufacture, and needs no attention from the engineer, unless the instrument is severely injured.

The stadia is a compound cross-wire ring or diaphragm, as shown in the cut, having three horizontal wires, of which the middle one is attached to the ring as usual, while the

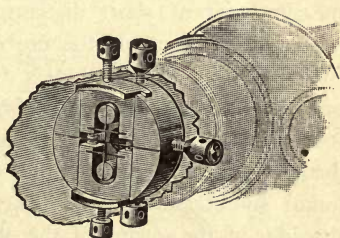

others are fastened to slides, held apart by springs and actuated by independent screws, by which the distance between the two movable wires can be adjusted to include a given space, as one foot on a rod one hundred feet distant.

These wires will in the same manner include two feet on a rod two hundred feet distant, or half a foot at a distance of fifty feet, and so on in the same proportion, thus furnishing a means of measuring distances, especially over broken ground, more easily and even more accurately than with a tape or

chain. Stadia wires are inserted in all our transit telescopes without extra cost, if requested when the instrument is ordered.

The stadia wires are fixed, when desired, on the same ring with the cross-wires, and when thus placed they are not adjustable, but are accurately and permanently set by us to read distances as above.

FIXED STADIA

The stadia wires are usually arranged so that they are seen at the same time as the cross-wires. When desired, we place them so that they are out of focus when the cross-wires are visible, or vice versa. Many engineers prefer this method, as being less confusing to the observer and lessening the liability of error.

DISAPPEARING STADIA

The increasing use of the stadia, often demanding the measurement of short distances with the utmost accuracy,

compels the use of the so-called stadia "constant"; that is, the wires are adjusted to read one foot on the rod at a distance from the center of the instrument of one hundred feet plus c plus f , c being the distance of the objective from the center of the instrument, found by measuring from the center of the axis to the shoulder of the setting of the objective when it is focused on a distant object, and f being the focal length of the objective, found by measuring from the cross-wires to the objective.

STADIA CONSTANT

The reason for this is that the rays cross each other so that the vertex of the visual angle is not at the center of the instrument, but at a distance in front of the objective equal to its focal length.

The constant for each instrument, or distance of the zero of the indicated distance in front of the center of the instrument, is noted on a card placed in the instrument box.

For example, in our eleven-inch telescopes, such as are used with our larger transits, $c = 5.6$ inches and $f = 8.2$ inches; $c + f = 1.15$ feet. In our Mountain Transit telescopes, $c = 4$ inches and $f = 5.4$ inches; $c + f = 0.783$ feet. In our Reconnaissance Transit telescopes, $c = 4.25$ inches and $f = 5.75$ inches; $c + f = 0.833$ feet.

This constant never varies for any given instrument, and is independent of the distance itself.

The dust guard to the objective slide, as shown in the cut, is placed on the tele-

DUST scopes of Tran-
GUARD sits Nos. 1 to 90, and Nos. 110 to 117.

This guard protects the objective slide, and prevents any dust or foreign substance from interfering with its perfect action.

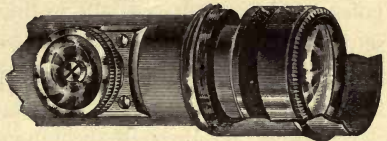

No. 154

Price of Dust Guard placed on an old Transit of our manufacture\$6.00

With the telescope of the ordinary transit it is impossible to focus on objects at a distance of less than ten feet.

SHORT order to enable the observer to see objects near the
FOCUS instrument, we have recently introduced an important modification of the telescopes used on our transits, so that they can be focused on an object at a distance of about four and one-half feet from the center of the instrument.

To facilitate the placing of the transit precisely under a given point, we now place in the top of the
CENTER ball of the telescope axis, and directly over the
POINT center of the instrument, a small conical hole or center point.

The standards of the transit are firmly attached by their

expanded bases to the upper plate, one of them having near the top a little box, as shown on page 44, **STANDARDS** movable by a screw underneath, by which the telescope axis is made precisely horizontal, as described on page 25.

The magnetic needle varies in length in the different sizes of transits. The brass cap has inserted in it a perfectly **MAGNETIC** polished jeweled center of special shape, and **NEEDLE** this, resting upon the hardened and polished point of the center-pin, allows the needle to play freely and settle in the magnetic meridian.

The needle has on its south end a coil of wire, easily moved to bring both ends of the needle to the same level. A screw passing through the upper plate moves a concealed lever by which the button is raised, thus lifting the needle from the pin so as to check its vibration, or to bring it up against the glass when not in use, avoiding unnecessary wear of the pivot.

The form of the needle is varied as desired by the maker or surveyor, but is of two general classes, one having the greatest breadth in a horizontal direction, the other in a vertical. We usually make our needles about eight one-hundredths of an inch broad, and about three one-hundredths of an inch thick, with the ends brought to a sharp vertical edge. We supply other forms, however, as desired.

The test of the delicacy of a magnetic needle is the number of horizontal vibrations which it will make in a certain arc before coming to rest. Most surveyors desire also a quivering motion in the needle. This quality, which is manifested more in a horizontal than in a vertical needle, depends upon the near coincidence of the point of suspension

with the center of gravity of the needle, and merely serves to show that the cap is unobstructed.

The compass box containing the needle is covered by a glass to exclude moisture and air. The circle is silvered and graduated on its upper surface into degrees and half-degrees, and figured from 0 to 90 each way. The degree marks are also cut down on the inner edge of the circle.

VARIATION ARC An arc for setting off the magnetic declination is furnished with any new Engineers' Transit, Nos. 1 to 16, if ordered with the instrument.

Price of Variation Arc with new Engineers' Transit.....\$4.00

The clamp and tangent movement has its tangent screw with opposing spring attached to the upper plate, as shown on page 6. The clamp is shown in the sectional cut on page 18, being a strong metal ring, D F, moving easily around the outer socket, to which it may be clamped by the screw, E, impinging upon a segment, F. The plates are thus held and moved slowly around each other in either direction by the tangent screw, or loosened and moved by the hand, the telescope being thus easily and accurately directed to the point of sight.

The two levels are placed at right angles with each other so as to level the plate in all directions, and are adjusted by turning the capstan-head nuts at their ends by a steel adjusting-pin. The glass vials used in the levels of all our transits are ground on their inner surface, to give the bubble an even motion and great sensitiveness.

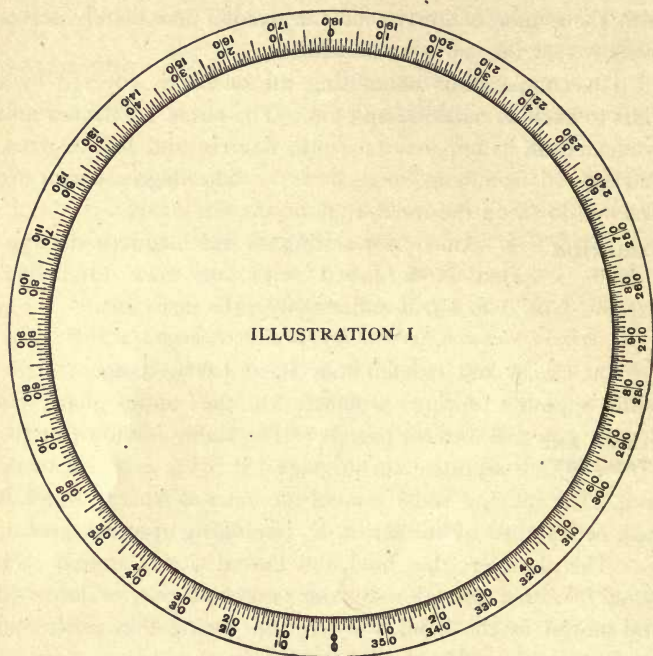

The limbs of all our transits, Nos. 1 to 102, are graduated on sterling silver, usually to half-degrees, and read by vernier **HORIZONTAL** to one minute. If desired, the limb and **LIMB** verniers may be graduated to read to thirty, twenty, or ten seconds, but at an additional cost.

Various methods of figuring are used, and we show illustrations of those which we most commonly employ.

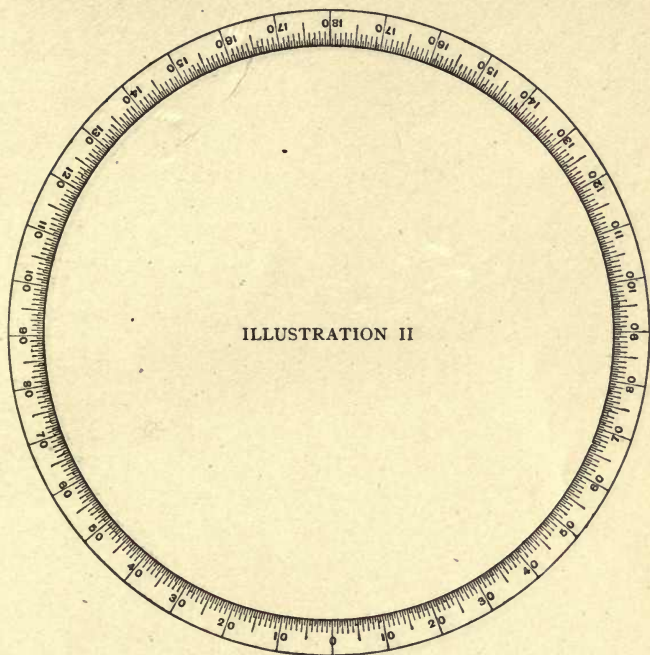

ILLUSTRATION I—The figures are in two rows, the outer from 0 to 360, and the inner in quadrants from 0 to 90. This mode is generally employed when not otherwise specified.

ILLUSTRATION II—The figures are in one row, reading from 0 each way to 180. This is the usual figuring on the limbs of Transits Nos. 20, 100, 102, and 105.

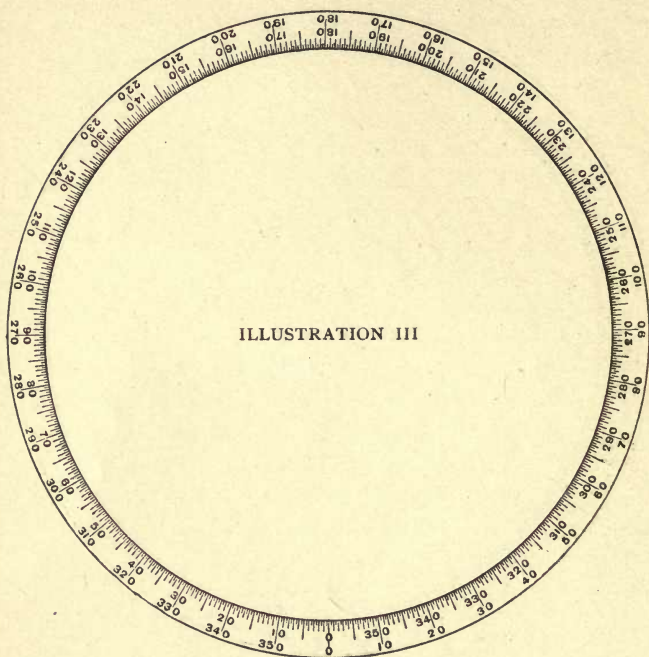
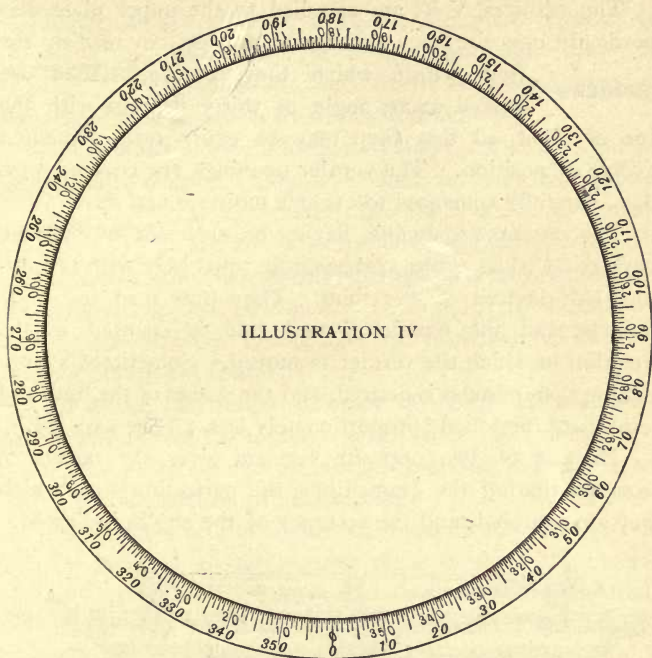

ILLUSTRATION III—The figures are in two rows, each row from 0 to 360, but running in opposite directions.

ILLUSTRATION IV—The numbering is identical with that used in III, except that the figures are inclined in the direction in which they increase.



We will furnish new transits with the limbs figured as specified by the purchaser, without extra charge, and limbs regraduated may be similarly figured as directed. Limbs cannot be refigured without regraduation and readjustment, the cost of readjustment being in addition to the regular charge for regraduation, as noted on page 262.

The verniers, V V, are attached to the upper plate diametrically opposite each other, and are used in reading the limb within which they revolve. They are placed at an angle of thirty degrees with the line of sight, so that they may be easily read without a change of position. The vernier openings are covered with glass, carefully cemented to exclude moisture and dust.

The verniers are double, having on each side of the zero mark thirty equal spaces corresponding precisely with twenty-nine half-degrees of the limb. They thus read to single minutes, and the number passed over is counted in the direction in which the vernier is moved. Sometimes a finer reading than minutes is desired, and the spaces of the limb and vernier are then made proportionately less. (See page 14.)

The use of two opposite verniers gives the means of cross-questioning the graduations, the perfection with which they are centered, and the accuracy of the angles indicated.

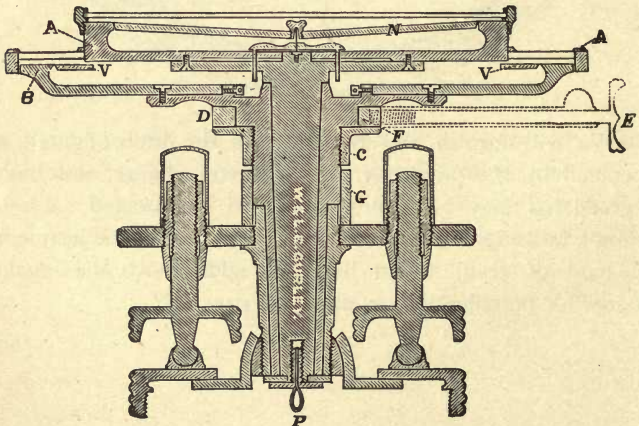

SOCKETS AND CIRCULAR PLATES

REFLECTORS Reflectors of celluloid, as in the Mountain Transit, are often used to throw white light upon the graduations, and shades of ground glass are sometimes used to give a more subdued light.

GRADUATIONS The graduations were formerly made on the brass surface of the limb, afterward filled with black wax and then finished and silvered. The limbs of all our transits are now covered with sterling silver. The graduations are much finer and more distinct, and the surface is less liable to become tarnished. This improvement, although adding considerably to the cost of manufacture, we make without additional charge.

To secure the utmost accuracy of graduation and avoid any possibility of molecular change after the graduation is made, the limbs of our transits are polished and the figures engraved before cutting the divisions.

SOCKETS The sockets of the transit are compound. The interior spindle attached to the vernier plate turns in the exterior socket, C, when an angle is taken on the limb; but when the plates are clamped the exterior socket itself, and with it the whole instrument, revolves in the socket of the leveling-head.

The sockets are constructed with the greatest care. They are truly concentric, and the composition of which they are made is of different degrees of hardness, causing them to move upon each other with the least possible wear.

LEVELING-HEAD The leveling-head consists of two plates connected by a socket, which has at its end a hemispherical nut fitting into a corresponding cavity in the lower plate. The plates are inclined to each other or made parallel by four leveling-screws. If specially ordered, we make the leveling-head with three leveling-screws.

The screws are of bronze and are fitted to long nuts in the upper leveling-plate. They are protected from dust by brass covers screwed on the upper ends of the nuts. The screws rest in cups or sockets, in which they turn without marring the surface of the lower plate, the cups also allowing the screws to be shifted from side to side, or turned in either direction on the lower plate.

The clamp and tangent movement of the leveling-head, partially shown on page 6, serves to turn the whole instrument upon its sockets, so as to fix the telescope with precision upon any given point, or when unclamped allows it to be directed approximately by hand. The tangent screw is single, as shown, and has an opposing spring by which lost motion is avoided and a very delicate and prompt movement secured.

The lower leveling-plate is in two pieces, the upper one, which is screwed to the top of the tripod, having a large opening in the center, in which the smaller
SHIFTING CENTER lower plate is shifted from side to side. By this device, called a shifting center, the instrument may be easily moved over the upper plate, and the plummet which hangs from the center, P (see page 18), may be set precisely over a point without moving the tripod.

The tripod has a head of bronze with three strong tenons to receive the legs, the upper ends of which are
TRIPOD pressed firmly on each side of the tenon by a bolt and nut on opposite sides of the leg. This nut can be screwed up, and thus kept firm. The lower end of the leg has a brass shoe with steel point, securely fastened and riveted to the wood.

For various patterns of tripods, see pages 186 to 189.

TO USE THE TRANSIT

The instrument should be set up firmly, the tripod legs being pressed into the ground, so as to bring the plates as nearly level as convenient. The plates should then be carefully leveled and properly clamped.

For precise work, in addition to leveling by the plate levels, it is always advisable, if the transit has such attachment, to level the plates by the telescope level, as this is much more sensitive than the levels on the plate. In this operation the position of the level on telescope must be observed over each pair of leveling-screws in turn, and one-half the correction made by the axis tangent, the other half by the leveling-screws.

Before an observation is made with the telescope, the eyepiece should be focused until the cross-wires appear distinct. The objective is then focused until the object is seen clear and well-defined, and the wires appear as if fastened to its surface. The intersection of the wires should be brought precisely upon the object to which the telescope is directed.

The zeros of the verniers and limb should be brought into line by the tangent screw of the plates, and the telescope directed to the object by the tangent screw of the leveling-head. The angles taken are then read off upon the limb, without subtracting from those given by the verniers in any other position.

TO ADJUST THE TRANSIT

Every instrument should leave the hands of the maker in complete adjustment, but all adjustments are so liable to derangement by accident or careless use that we consider it necessary to describe particularly those which are most likely to need attention.

The principal adjustments of the transit are: the Levels, the Line of Collimation, the Standards.

To adjust the levels: Set the instrument upon its tripod as nearly level as may be, and having unclamped the plates,

LEVELS bring the two levels above, and on a line with, the two pairs of leveling-screws. Clasp the heads of two opposite screws, and, turning both in or out, as may be needed, bring the bubble of the level directly over the screws exactly to the middle of the opening. Without moving the instrument, proceed in the same manner to bring the other bubble to the middle. The level first corrected may now be thrown a little out; if so, bring it in again, and when both are in place turn the instrument half-way around. If the bubbles are both in the middle they need no correction; but if not, turn the nuts at the end of the levels with the adjusting-pin, until the bubbles are moved over half the error. Bring the bubbles again into the middle by the leveling-screws, and repeat the operation until the bubbles will remain in the middle during a complete revolution of the instrument.

To adjust the line of collimation: This adjustment is to bring the cross-wires into such a position that the instrument,

LINE OF COLLIMATION when placed at the middle of a straight line, will, by the transit of the telescope, cut the extremities of the line. Having leveled the instrument, determine if the vertical wire is plumb, by focusing on a defined point and observing if the wire remains on that point when the telescope is elevated or depressed. If not, loosen the cross-wire screws and by their heads turn the ring until correct, the openings in the telescope tube being slightly larger than the screws, so that when the latter are loosened the ring can be rotated a short distance in either direction.

Direct the intersection of the cross-wires on an object two or three hundred feet distant. Set the clamps and transit to an object about the same distance in the opposite direction. Unclamp, turn the plates half-way around, and direct again to the first object; then transit to the second object. If it strikes the same place the adjustment is correct. If not, the space which intervenes between the points bisected in the two observations will be double the deviation from a true straight line, since the error is the result of two observations.

In the diagram below, let A represent the center of the instrument, and B C the imaginary straight line, upon the extremities of which the line of collimation is to be adjusted. B represents the object first selected, and D the point which the wires bisected when the telescope was reversed.

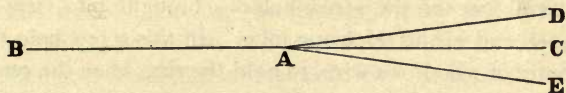

When the instrument is turned half around, and the telescope again directed to B, and once more reversed, the wires will bisect an object, E, situated as far to one side of the true line as the point, D, is on the other side. The space, D E, is therefore the sum of two deviations of the wires from a true straight line, and the error is made very apparent.

In order to correct it, use the two capstan-head screws on the sides of the telescope, these being the ones which affect the position of the vertical wire. It must be kept in mind that the eyepiece apparently inverts the position of the wires, and therefore, in loosening one of the screws and tightening the other on the opposite side, the operator must proceed as if to increase the error observed.

The wires being adjusted, their intersection may now be

brought into the center of the field of view by moving the screws, A A, shown in the sectional view of the telescope on page 7, which are slackened and tightened in pairs, the movement being now direct, until the wires are seen in their proper position.

The position of the line of collimation depends upon that of the objective solely, so that the eyepiece may, as in the case just described, be moved in any direction, or even removed and a new one substituted, without at all deranging the adjustment of the wires.

In case it becomes necessary to remove the cross-wire ring, the operator should proceed as follows: Take out the eyepiece, together with the ring by which it is centered, remove two opposite cross-wire screws, and with the others turn the ring until one of the screw holes is brought into view from the open end of the telescope tube. In this screw hole thrust a splinter of wood or a wire, to hold the ring when the remaining screws are withdrawn. The ring can then be removed. It may be replaced by returning it to its position in the tube, and after either pair of screws is inserted the splinter or wire is removed, and the ring is turned until the other screws can be replaced, care being taken that the face of the diaphragm is turned toward the eyepiece. The eyepiece is next inserted, and its centering-ring brought into such a position that the screws in it can be replaced, and the ring into which the eyepiece is fixed is then screwed to the end of the telescope.

To adjust the standards: In order that the point of intersection of the wires may trace a vertical line as the telescope is elevated or depressed, it is necessary that the standards of the telescope should be of precisely the same height. To ascertain this, and make the correction, if needed, proceed as follows:

STANDARDS

Having the line of collimation properly adjusted, set up the instrument in a position where points of observation, such as the apex and base of a lofty spire, can be selected, giving a long range in a vertical direction.

Level the instrument, direct the telescope to the top of the object, and clamp to the spindle; then bring the telescope down until the wires bisect some well-defined point at the base. Turn the instrument half around, direct the telescope to the lower point, clamp to the spindle, and raise the telescope to the highest point. If the wires bisect it, the vertical adjustment is effected; if they are thrown to either side, this proves that the standard opposite to that side is the highest, the apparent error being double that actually due to this cause. To correct it, we make one of the bearings of the axis movable, so that by turning a screw underneath this sliding piece, as well as the screws which fasten the cap of the standard, the adjustment is made with the utmost precision.

Besides the three adjustments described, which are all that the surveyor will ordinarily be required to make, there are other adjustments of the transit which may sometimes be necessary.

In case of accident or injury it may be necessary to adjust the objective slide, and this should be done as follows: Having set up and leveled the instrument, the line of collimation being adjusted for objects from three hundred to five hundred feet distant, clamp the plates, and fix the vertical cross-wire upon an object as distant as may be distinctly seen. Without disturbing the instrument, move out the objective so as to bring the vertical wire upon an object as near as the range of the telescope will allow. Having this clearly in mind, loosen the upper clamp, turn the instrument half-way around, reverse the telescope, clamp the

instrument, and with the tangent screw bring the vertical wire again upon the near object; then draw in the objective until the distant object first sighted upon is brought into distinct vision. If the vertical wire strikes the same line as at first, the slide is correct for both near and remote objects, and, being itself straight, for all distances.

But if there is an error, proceed as follows: With a screw-driver turn the two screws, C C (see page 7), on the opposite sides of the telescope, loosening one and tightening the other, so as to apparently increase the error, making, by estimation, one-half the correction required. Then go over the usual adjustment of the line of collimation, and, having completed it, repeat the operation above described, first sighting upon the distant object, then upon a near one in line, then reversing, making corrections, etc., until the adjustment is complete.

This adjustment is peculiar to our transits, and furnishes the only way in which the line of collimation can be made correct for all distances.

The adjustments of the vertical circle and the level on telescope are described on pages 55 to 60.

ENGINEERS' TRANSIT

THE circular plates of the Engineers' Transit, with their sockets, are shown in section on page 18. The upper plate, A A, carrying the compass circle, is screwed to the flange of the interior spindle; the lower plate or divided limb, B, is fastened to the exterior socket, C, which again is fitted to and turns in the hollow socket of the leveling-head.

The long sockets of the transit are supported in the leveling-head, which is secured to the sockets by a screw and washer underneath.

The engraving on page 29 shows some of the attachments often used with the transit; the vertical arc, level on **ATTACHMENTS TO TRANSITS** telescope, and clamp and tangent to telescope axis with gradienter screw. These and other attachments are used where leveling, taking vertical angles, etc., must be done in connection with the ordinary work of the transit, and the attachments and their adjustments are described on pages 54 to 77.

We make three sizes of the Engineers' Transit, having **SIZES AND WEIGHTS** needles respectively four, four and one-half, and five inches long. The average weight of each size, with plain telescope, is as follows:

4-inch needle, about	12½ lbs.
4½-inch needle, about	14 lbs.
5-inch needle, about	16 lbs.

The tripod furnished with this transit weighs between nine and ten pounds.

LIBRARY OF THE UNIVERSITY OF CALIFORNIA

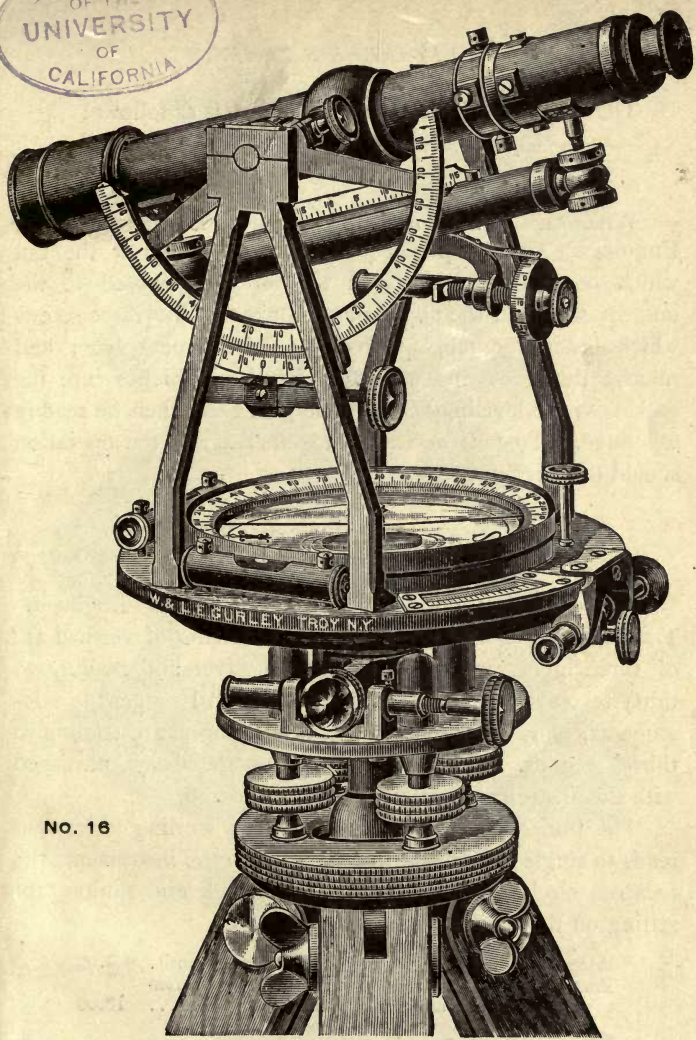

No. 16

Engineers' Transit, two verniers to limb, 5-inch needle, with 6-inch vertical arc with vernier moved by tangent screw and reading to 30 seconds, level on telescope, gradienter combined with clamp and tangent, and tripod.
Price, as shown, \$198.00.

The diameter of the limb of each size is as follows :

4-inch needle	5.65 inches
4½-inch needle	6.25 inches
5-inch needle	6.70 inches

When it is necessary to separate the plates of the Engineers' Transit, proceed as follows: Unscrew the nut which confines the spring in the thimble opposed to the tangent screw on the upper plate; take out the three screws which fasten the tangent fixture to the upper plate; and remove the screw and washer underneath, which secure the sockets to the leveling-head. The plates can then be readily separated. To put the transit together again, the operation should be exactly reversed.

ENGINEERS' TRANSIT WITH SOLAR ATTACHMENT

The engraving on page 31 represents our Engineers' Transit with five-inch needle and attachments of vertical arc of three inches radius, graduated on silver and reading to thirty seconds, level on telescope, clamp and tangent to telescope axis, and solar apparatus with declination arc reading to thirty seconds. Platinum stadia wires are always furnished with this instrument, unless otherwise ordered.

The horizontal limb is graduated on sterling silver and reads to single minutes. If ordered with the instrument, the compass circle is made movable with rack and pinion, for setting off the magnetic declination.

Price of Variation Arc with new Engineers' Transit.	\$ 4.00
Price of Variation Arc added to any Engineers' Transit sent to us for addition of Solar Attachment. . . .	15.00

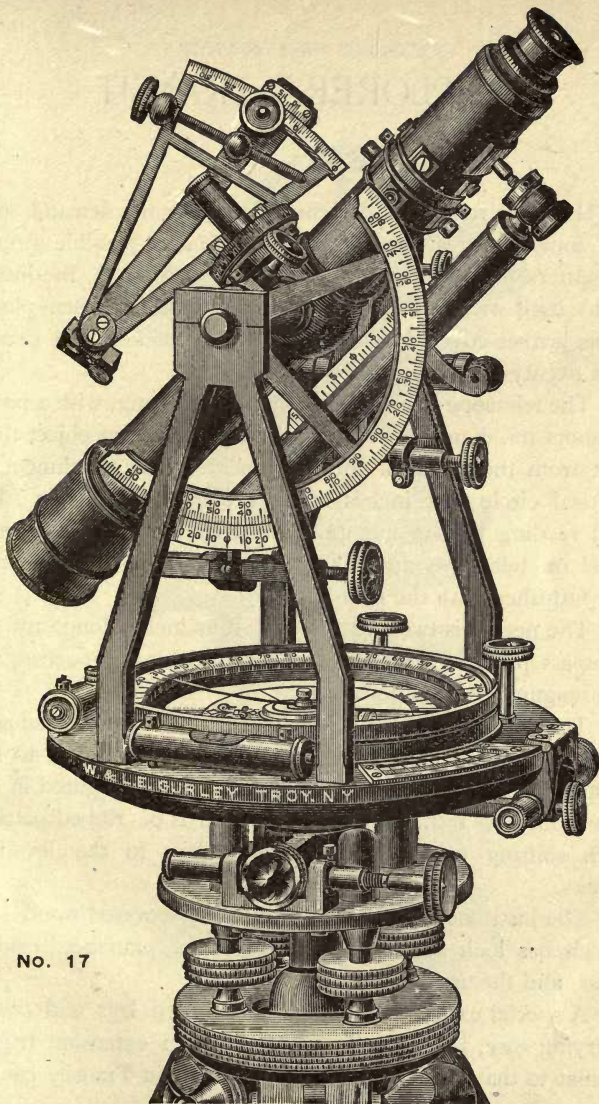

No. 17

ENGINEERS' TRANSIT, WITH SOLAR ATTACHMENT
Price, as shown, \$250.00.

EXPLORERS' TRANSIT

THIS instrument is designed to supply the demand for a transit of greatest accuracy with the least possible weight. In pattern similar to our Light Mountain Transit, the instrument itself weighs only about five pounds, and when placed in its leather-covered case can be readily packed and carried in a twenty-four-inch dress-suit case.

The telescope is six and one-half inches long, with a power of about ten diameters, and can be focused on an object three feet from the center of the instrument. The attachments of vertical circle four inches in diameter, graduated on silver and reading to one minute, figured from 0 to 90 each way, level on telescope, and clamp and tangent to telescope axis, are furnished with the transit.

The needle is two and three-quarters inches long, and the compass plate is arranged with a variation arc for setting off the magnetic declination.

The horizontal limb is four inches in diameter, graduated on silver, and reads by two opposite double verniers to one minute. Unless otherwise ordered, the limb is figured in one row from 0 to 180. The leveling-head is of ribbed pattern, with shifting center, and has dust caps to the leveling-screws.

The instrument is packed in a leather-covered wood box, which has lock and key, shoulder strap, plummet, reading glass, and the usual small accessories.

A special extension tripod, with pointed legs and canvas carrying case, is usually furnished; but an extension tripod, similar to that used with the Light Mountain Transit, can be

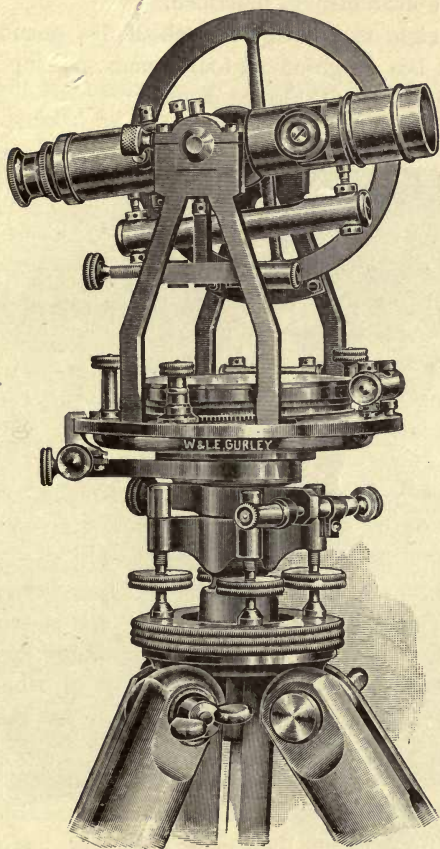

No. 20

EXPLORERS' TRANSIT
Price, as described, \$165.00.

substituted, if desired, at a reduction of five dollars from the price of the instrument as described.

The weight of the tripod is about five pounds and the instrument box weighs about four pounds, making the weight of the complete outfit thirteen pounds.

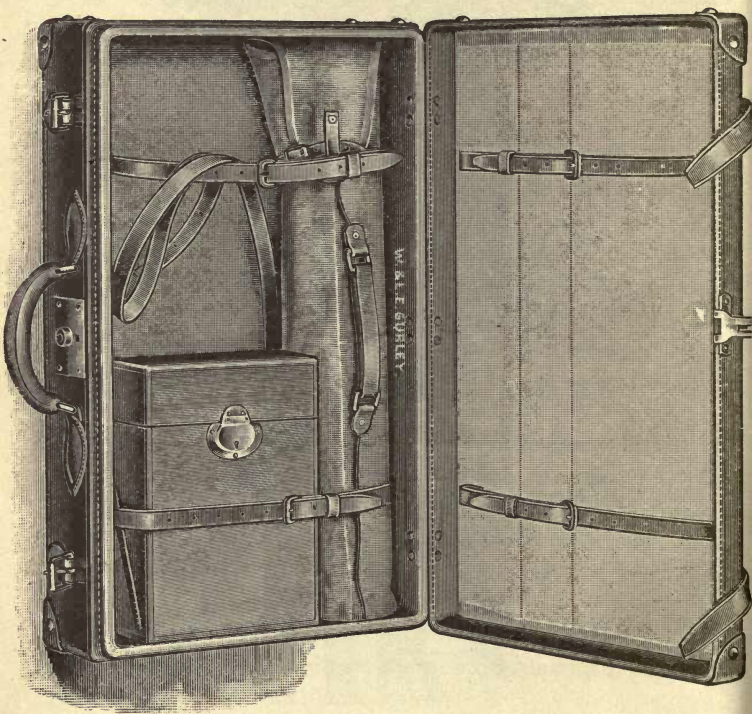

The Explorers' Transit in its box and the tripod with the jointed legs in its case can be packed and carried in an ordinary 24-inch dress-suit case, as shown.

If desired, we can furnish a good leather dress-suit case for \$8.00 extra.

LIGHT MOUNTAIN TRANSIT

THE Light Mountain Transit, introduced by us in 1876 to meet a demand for a light instrument of the finest quality, has met with a very large sale and has been universally approved. It is especially fitted for mine or mountain surveying, where great portability is essential, but is equally adapted to the general work of the engineer. The instrument, shown on page 36, has a needle four inches long, and a telescope eight inches long with a power of twenty diameters. Platinum stadia wires are always furnished with this instrument, unless otherwise ordered.

The sockets are like those shown on page 18. The compass circle is movable about its center, so as to set off the magnetic declination.

The limb has a diameter of five and sixty-five hundredths inches, and is graduated on silver, reading usually to single minutes; but, if desired, it can be graduated to read to twenty or thirty seconds. There are caps above the leveling-screws to exclude dust.

The cut shows the celluloid reflectors, placed over the two opposite verniers of the limb to throw light upon the graduations below, which are of special convenience in the surveys of mines.

The Mountain Transit is sometimes used with a plain telescope, but oftener with one or more attachments, as vertical

ATTACHMENTS arc, level and clamp and tangent, as shown.
FOR TRANSITS Frequently this instrument is furnished as shown on page 37, with vertical arc, level, clamp and tangent, and solar attachment.

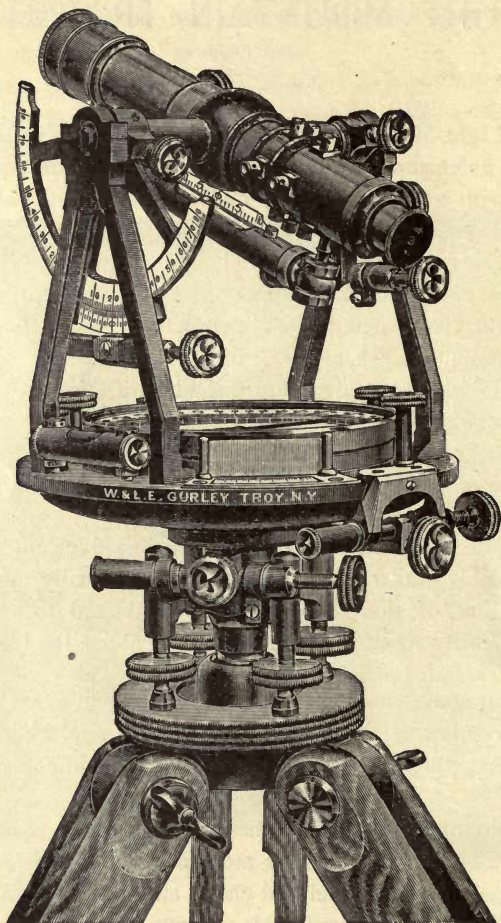

NO. 28

Light Mountain Transit, two verniers to limb, 4-inch needle, with vertical arc, level on telescope, and clamp and tangent to telescope axis, and extension tripod.

Price, \$186.00.

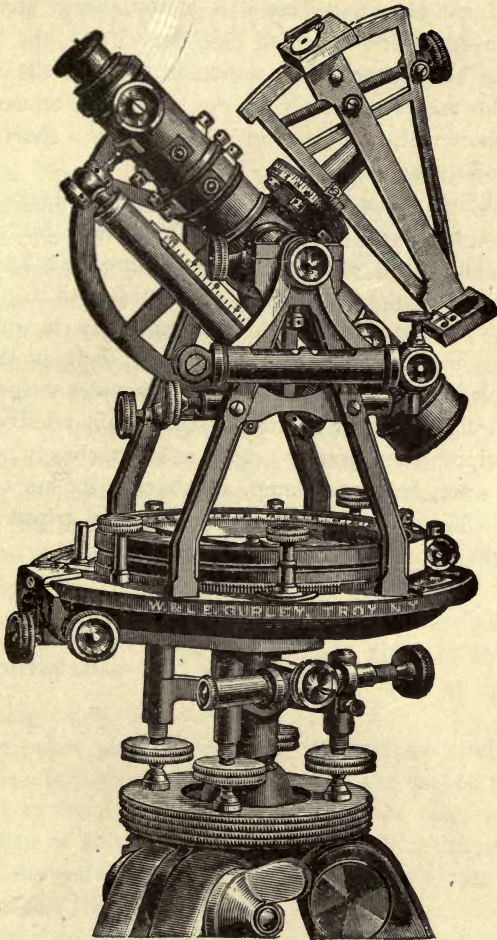

NO. 30

Light Mountain Transit, two verniers to limb, 4-inch needle, with solar attachment, vertical arc reading to 1 minute, level on telescope, and clamp and tangent to telescope axis, and extension tripod. Price, \$245.00.

The Light Mountain Transit is almost always used upon our improved extension tripod (see page 189), the legs of which can be lengthened or shortened at will. It is thus adapted for use in mountain surveys, where one or more legs must be shortened, or for use in mines, where a short tripod is often indispensable.

The sliding pieces can be turned end for end, the points being thus out of the way and the tripod more easily transported. The tripod when closed is only three feet long, and is carried by a shawl strap, which we furnish with it.

LEATHER CASE Besides the light mahogany box, in which the instrument is packed as usual, there is also supplied a sole-leather case, furnished with shoulder straps.

The weight of this instrument with plain telescope and without tripod is ten pounds; with solar attachment, vertical arc, level and clamp, as shown in the cut on page **WEIGHT** 37, twelve pounds. The extension tripod weighs about eight and one-half pounds.

SURVEYORS' TRANSIT

WITH TWO VERNIERS TO THE HORIZONTAL LIMB

THE Surveyors' Transit with two verniers to limb has essentially the same construction as the Engineers' Transit, but its compass circle is movable about its center, like that of the Mountain Transit, in order that the magnetic declination may be set off in the surveys of old lines, or in running lines by the true meridian.

The arrangement of the sockets and leveling-head permits the Surveyors' Transit to be detached from the **SOCKETS** leveling-head and replaced upon its spindle, when desired, without disturbing its adjustments.

The sectional view (page 41) shows the interior construction of the sockets of the transit, the manner in which it is detached from its spindle, and the means by which it can be taken apart.

In the figure the limb, B, is attached to the main socket, **HORIZONTAL LIMB** C, which is itself fitted to the conical spindle, H, and held in place by the spring catch, S.

The upper plate, A, carrying the compass circle, standards, etc., is fastened to the flange of the socket, K, which is fitted to the upper conical surface of the main socket, C, the weight of all the parts being supported on the small bearings of the end of the socket, as shown, so as to turn with the least possible friction.

A small conical center, in which a screw is inserted from below, is brought down firmly upon the upper end of the main socket, C, thus holding the two plates of the instrument

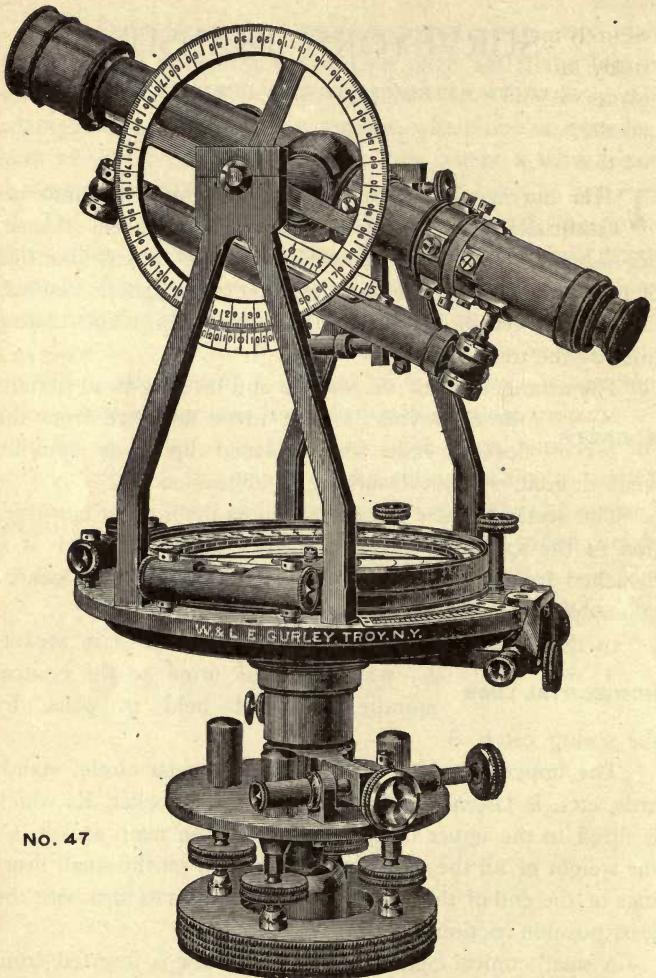

NO. 47

Surveyors' Transit, two verniers to limb, 5-inch needle, with $4\frac{1}{2}$ -inch vertical circle with vernier to 1 minute, level on telescope, clamp and tangent to telescope axis, and tripod. Price, \$160.00.

securely together, and at the same time allowing them to move freely around each other in use. A disk above the conical center contains the steel center-pin upon which rests the needle, as shown, the disk being fastened to the upper plate by two screws.

The clamp to limb, with clamp screw, is also shown at D F, attached to the main socket below.

The main socket, with all its parts, is of the best bell metal, and is most carefully and thoroughly made, the long bearing of the sockets insuring their firm and easy movement, while at the same time they are entirely out of reach of dust or other source of wear.

When desired, the whole upper part of the instrument may be taken off from the spindle by pulling out the head of the

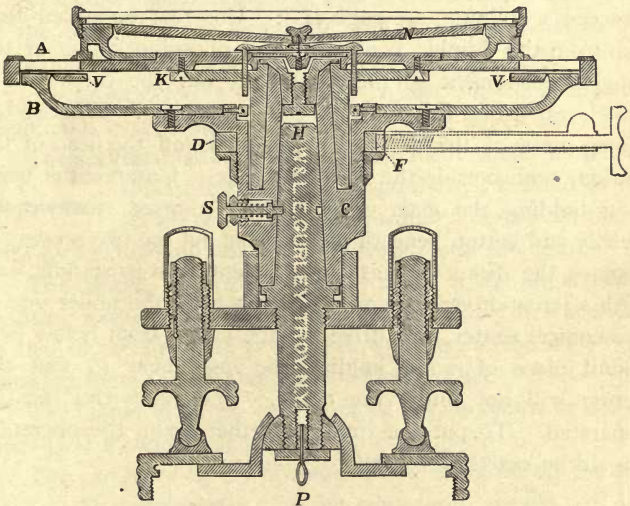

SOCKETS AND CIRCULAR PLATES

spring catch at S, and when replaced will be secured by the self-acting spring of the catch.

The figure also shows the covers of the leveling-screws, the shifting center of the lower leveling-plate, and the screw and loop for the attachment of the plummet.

SIZES AND WEIGHTS The sizes and weights of the Surveyors' Transit with two verniers to limb, and having plain telescope, are :

- 4-in. needle, with leveling-head, but no tripod, about 13 $\frac{3}{4}$ lbs.
- 5-in. needle, " " " " " " 16 $\frac{1}{2}$ lbs.
- 5 $\frac{1}{2}$ -in. needle, " " " " " " 17 $\frac{1}{2}$ lbs.

The diameter of the limb of each size is as follows :

4-inch needle	5.65 inches
5-inch needle	6.70 inches
5 $\frac{1}{2}$ -inch needle	7.20 inches

When it is necessary to separate the plates of this transit, proceed as follows (see page 41):

Unscrew the milled-head cap from the thimble containing the opposing spring of the tangent movement to limb, and take out the three screws which fasten that movement to the upper plate. Remove the clamp screw of the variation arc and take off the head of the pinion, both outside the compass circle. Unscrew the bezel ring holding the glass cover of the compass, remove the needle and button beneath it, and take out the two screws, to remove the disk. Take the instrument from its spindle, and with a screw-driver take out the screw from the under side of the conical center, and drive out the center from below by a round piece of wood, holding the instrument so that the center will not bruise the circle. The plates can then be separated. To put the transit together again, the operation should be exactly reversed.

SURVEYORS' TRANSIT

WITH ONE VERNIER TO THE HORIZONTAL LIMB

THE Surveyors' Transit with one vernier to limb is a modification of the instrument just described, in which there is but one double vernier to limb and a different arrangement of the sockets, as shown in the sectional cut on page 45.

The instrument is more compact and somewhat lighter than that with two verniers, and is furnished at less cost. Its graduations, telescope, and attachments are equal to those of the more costly transits; and after an experience of more than forty years the instrument has proved itself satisfactory for all classes of work.

The adjustments and use of this instrument are like those of the others already described, and its attachments to the telescope the same, if desired.

It is represented in the cut with a level on telescope and clamp and tangent to telescope axis. (See page 44.)

The sectional cut shows the arrangement of the sockets of this instrument. The spindle, C, is fitted to the **SOCKETS** socket of the leveling-head, and connected therewith by a screw and washer underneath, as in the figure.

The socket, K, is formed in the metal of the upper plate, a strong washer with four screws, only two of which are seen in the cut, keeping the two plates together, at the same time allowing them to turn freely around each other.

The clamp to limb, with clamp screw, is shown in dotted lines at D F, under the plates.

The vernier with the opening above is shown on the left at A. The arrangement of the center-pin, needle, etc., is

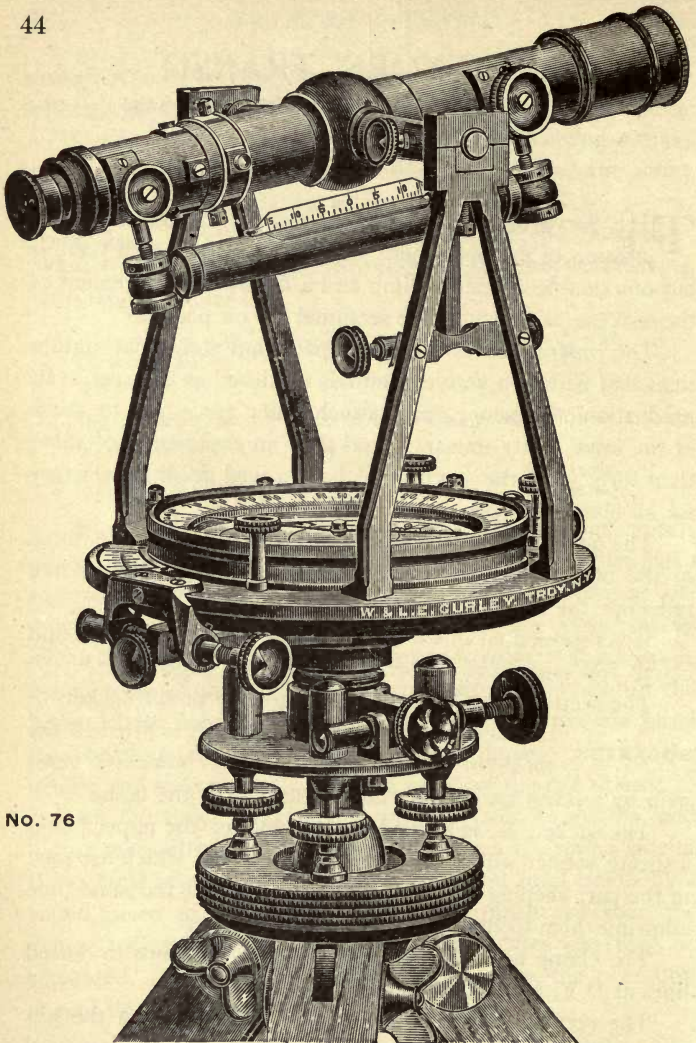

No. 76

Surveyors' Transit, one vernier limb, 5-inch needle, with level on telescope, clamp and tangent to telescope axis, and tripod.
Price, \$133.00.

like that of the transit with two verniers, but the instrument remains attached to the leveling-head like the Engineers' Transit.

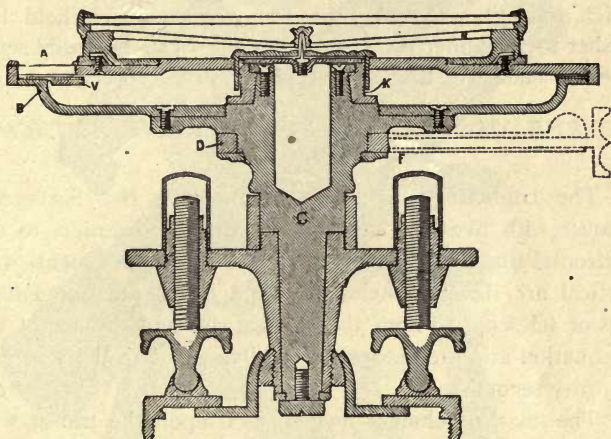

SOCKETS AND CIRCULAR PLATES

SIZES AND WEIGHTS

The sizes and weights of the Surveyors' Transit with one vernier to limb, and having plain telescope, are :

- 4-in. needle, with leveling-head, but no tripod, about 13 lbs.
- 5-in. needle, " " " " " " 16 lbs.
- 5½-in. needle, " " " " " " 17 lbs.

The diameter of the limb of each size is as follows :

- 4-inch needle 5.65 inches
- 5-inch needle 6.70 inches
- 5½-inch needle 7.20 inches

To take apart the Surveyors' Transit with one vernier to limb: Unscrew the milled-head cap of the tangent opposing spring, and take out the three screws which secure the tangent support to the upper plate. Remove the pinion head and

clamp screw near the compass circle; unscrew the bezel ring, take out the needle and button underneath, and remove the disk in which the center-pin is fixed, by taking out two screws which hold it. Remove the four screws which hold the washer to the under plate, and the plates can be easily separated. The several parts are replaced in the reverse order.

SURVEYORS' TRANSIT WITH SOLAR ATTACHMENT

The engraving on page 47 represents our Surveyors' Transit with five-inch needle and with two verniers to the horizontal limb, to which is added the solar attachment, with vertical arc, level on telescope, and clamp and tangent to axis of telescope. Both the vertical arc and the arc of the declination arm are graduated on silver, and read by vernier to thirty seconds.

The solar attachment may be used upon the transit with two verniers to limb or with one vernier to limb, as preferred. Both instruments are provided with shifting center to the leveling-head. Platinum stadia wires are furnished with every solar instrument, unless otherwise ordered.

The Surveyors' Transit having one vernier to the limb has sockets as shown on page 45, and when fitted with the solar attachment is listed as No. 90.

PRICES

No.		
60	Surveyors' Transit, two verniers to limb, 5-inch needle, with Solar Attachment, vertical arc of 3 inches radius, level on telescope, clamp and tangent to telescope axis, and tripod	\$226.00
90	Surveyors' Transit, one vernier to limb, 5-inch needle, with Solar Attachment, vertical arc of 3 inches radius, level on telescope, clamp and tangent to telescope axis, and tripod.....	211.00

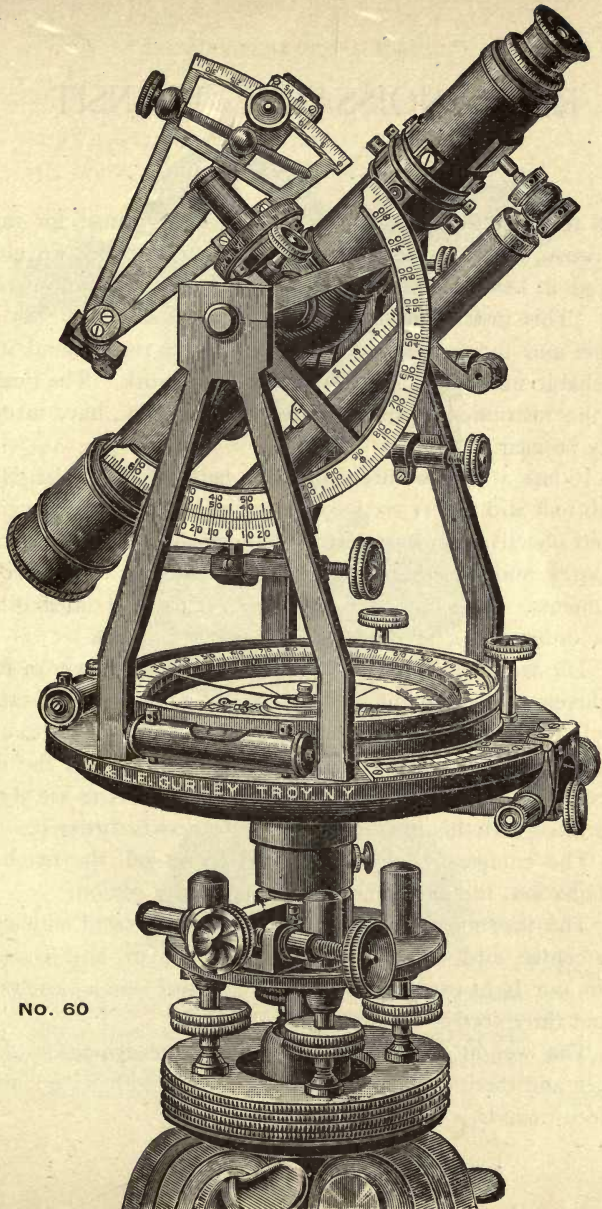

No. 60

SURVEYORS' TRANSIT WITH SOLAR ATTACHMENT

RECONNOISSANCE TRANSIT

IN response to a demand for a very light transit for rapid work, where extreme accuracy is not required, we introduced in 1887 the Reconnaissance Transit, as shown on page 49. This instrument is finished with the same care as our larger and more expensive transits, and we recommend it as a reliable instrument for a great variety of work. The quality of the instrument, together with its portability, have made it very popular.

It has a needle three and one-half inches in length, a limb four and ninety-six hundredths inches in diameter, graduated on silver and reading by one double vernier to single minutes, and a spring tangent movement like the larger instruments. The limb is figured from 0 to 180, unless otherwise ordered.

The telescope is nine inches long and has a power of from eighteen to twenty diameters. It has a long level, vertical circle reading to five minutes, and clamp and tangent to axis. The objective is focused by a rack and pinion and the eyepiece by a spiral movement. Platinum stadia wires are always furnished with this instrument, unless otherwise ordered.

The compass circle is arranged to set off the magnetic declination, the movement being made by a pinion.

The instrument has, as shown, a leveling-head with shifting center, and with spring clamp and tangent, and it is used upon our light extension tripod, the legs of which close up to about three feet in length.

The weight of this transit without the tripod is about seven and three-quarters pounds; complete with tripod, about fifteen pounds.

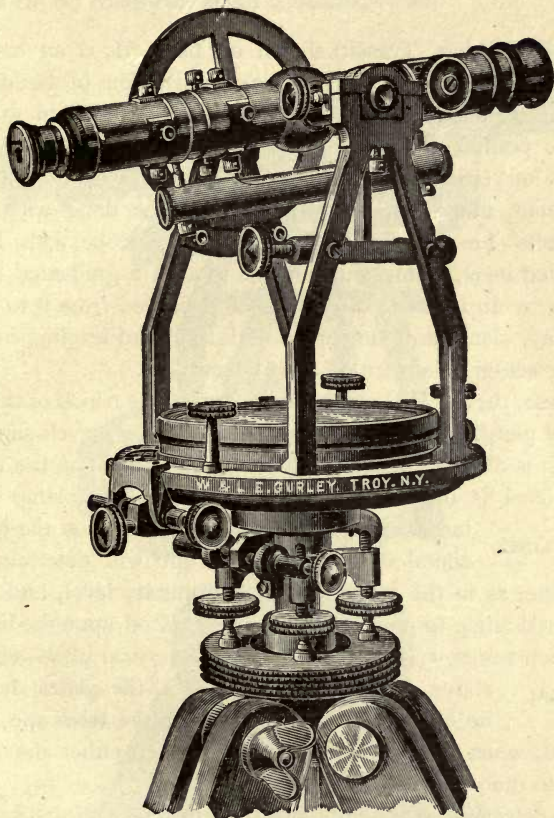

No.	NO. 100	PRICE
100	Reconnissance Transit, one vernier to limb, $3\frac{1}{2}$ -inch needle, with $3\frac{1}{2}$ -inch vertical circle with vernier reading to five minutes, level on telescope, clamp and tangent to telescope axis, and leveling tripod with extension legs. . . .	\$115.00
102	Reconnissance Transit, same as No 100, but with $4\frac{1}{2}$ -inch vertical circle with vernier reading to one minute.	122.00

BUILDERS' TRANSIT

THE Builders' Transit, shown on page 51, is an instrument devised for use in the construction of buildings where it is necessary not only to furnish levels, but to determine points in a vertical plane above or below the level line, or on either side and in line with the center of the instrument, more conveniently than can be done with the Architects' Level. This transit has a telescope with long graduated level, clamp and tangent to axis, a graduated limb reading by an index to one degree and figured from 0 to 180 each way, clamp and tangent to both limb and leveling-head, shifting center, plain tripod, and trivet plate.

In use, the instrument is set either upon the tripod or trivet, and the plates are accurately leveled by the two levels shown.

If it is desired to run a level line, the bubble of the telescope level is brought into the middle by the clamp and tangent of the axis, in which position the horizontal wire of the telescope will determine a level line, as in the telescope of the ordinary level, and any horizontal angle to one degree may be read off upon the limb.

LEVEL LINE

When necessary to obtain points in a vertical plane, either above or below a given point, the plates should be clamped and the clamp of the telescope axis released, when the telescope may be directed either above or below to the point desired.

VERTICAL LINE

To determine two points in a straight line with the instrument and on opposite sides of its center, direct the telescope to one of the points, clamp the plates, and obtain the other point by reversing the telescope upon its axis.

STRAIGHT LINE

The weight of the Builders' Transit is about seven pounds ; with tripod complete, about thirteen pounds.

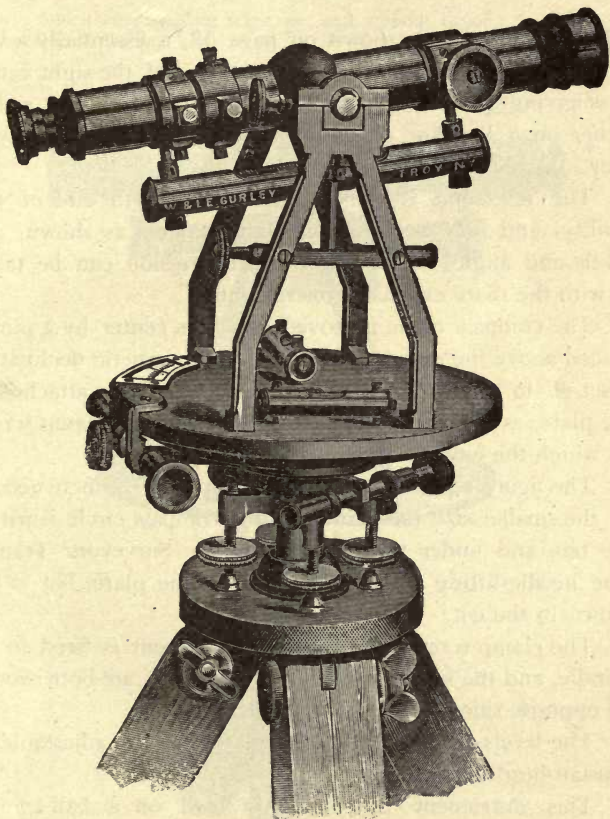
**No. 105**

Builders' Transit, with level on telescope, clamp and tangent to telescope axis, limb and spindle, and with leveling-screws and tripod.
Price, \$80.00.

VERNIER TRANSIT COMPASS

THIS instrument, shown on page 53, is essentially a vernier compass with a telescope instead of the sight vanes, thus giving the surveyor the means of taking long sights, either on a level or on hilly ground, with ease and accuracy.

The telescope is eleven inches in length and of fine quality, and may be fitted with attachments as shown, and levels and angles of elevation and depression can be taken as with the more expensive instruments.

The compass circle is moved about its center by a pinion placed above the circular plate, and the magnetic declination is set off to single minutes upon a graduated arc attached to the plate, as shown in the cut. There is also a clamp screw, by which the circle may be made secure.

The figure represents the instrument with six-inch needle. In the smaller size the vernier of the compass circle is within the box and under the glass, as in the Surveyors' Transit. The needle-lifting screw is underneath the plate, but is not shown in the cut.

The clamp screw, by which the instrument is fixed to the spindle, and the spring catch which secures it, are both shown, on opposite sides of the socket.

The levels are both above the plate, and are adjustable by capstan-head nuts at either end.

This instrument is commonly used on a ball-spindle placed in a compass tripod, as shown on page 53; but it is sometimes fitted to a leveling-head, like that shown on page 132.

We make two sizes of this instrument, having needles
SIZES AND respectively five and six inches in length. The
WEIGHTS average weights are as follows:

5-inch needle, plain telescope, and without tripod, 9 lbs.
 6-inch needle, " " " " " " 11 $\frac{3}{4}$ lbs.

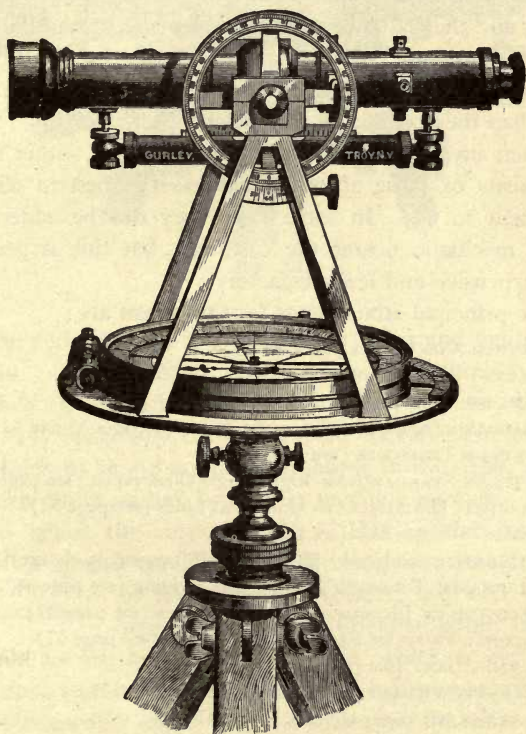

NO. 117

Vernier Transit, 6-inch needle, with 3 $\frac{1}{2}$ -inch vertical circle with vernier reading to 5 minutes, level on telescope, clamp and tangent to telescope axis, and tripod.
 Price, \$101.00.

ATTACHMENTS FOR TRANSITS

IN the use of the transit it is generally found advisable to add one or more attachments to the telescope. All our transits and their attachments are now made to standard sizes, so that one or more of these useful accessories can be fitted to the instrument at any time without additional expense other than the cost of the attachment itself.

When any of these attachments are desired, either for our instruments or those of other makers, it is best to send the instrument to us. In some cases they can be added by a skillful mechanic nearer the customer, but this is generally more expensive and less satisfactory.

The principal attachments for the transit are :

VERTICAL CIRCLE (see pages 55-57).

VERTICAL ARC (see page 58).

LEVEL ON TELESCOPE (see page 59).

CLAMP AND TANGENT to Telescope Axis (see pages 59 and 61).

SIGHTS ON TELESCOPE (see page 61).

SIGHTS ON STANDARDS for Right Angle Observation (see page 61).

ATTACHED MAGNIFIERS to Horizontal Limb (see page 61).

BEAMAN STADIA ARC (see page 62).

GRADIENTER, combined with Clamp and Tangent (see page 64).

DETACHABLE TELESCOPES for Vertical Sighting (see page 66).

REFLECTOR for Illuminating the Cross-Wires (see page 67).

DIAGONAL PRISM for Eyepiece of Telescope (see page 67).

PLUMMET LAMP (see page 68).

SOLAR ATTACHMENT to Telescope (see pages 69-77).

SOLAR SCREEN (see page 89).

VERTICAL CIRCLE

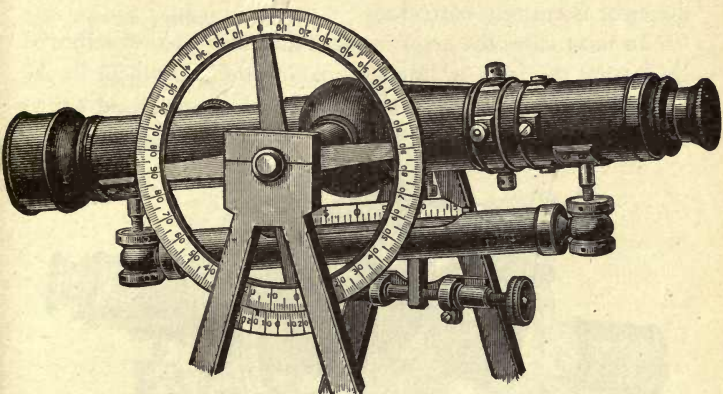

No. 136

The vertical circle is graduated on silver and figured from 0 to 90. Three sizes are generally used, the three and one-half-inch circle reading by vernier to five minutes, as shown in No. 117 (page 53), the four and one-half-inch circle reading by vernier to single minutes, as shown in No. 136, and the five-inch circle reading by vernier to single minutes.

ADJUSTMENT To adjust the vertical circle: Having the instrument firmly set up and carefully leveled, bring into line the zeros of the circle and vernier, and with the telescope find some well-defined point, from one hundred to five hundred feet distant, which is cut by the horizontal wire. Turn the instrument half-way around, transit the telescope, and fixing the wire upon the same point as before, observe if the zeros are again in line. If not, loosen the capstan-head screws which fasten the vernier, and move the zero of the vernier over half the error; bring the zeros

again into coincidence, and proceed exactly as before, until the error is entirely corrected.

In most cases the error is slight and may be best removed by putting the zeros in line and making the adjustment by the horizontal wire, moving it by the vertical capstan-head screws until the vertical circle will reverse on the same point.

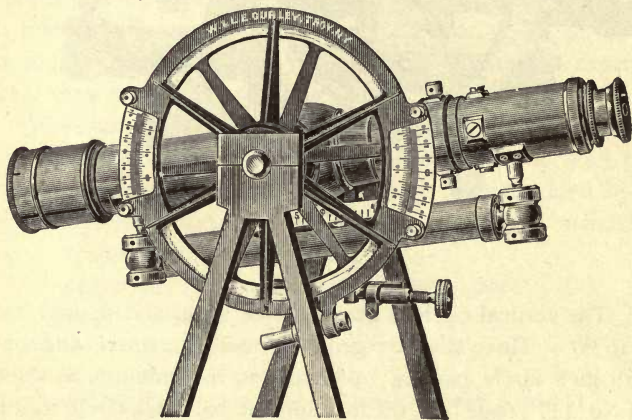

No. 138

VERTICAL CIRCLE WITH OPPOSITE VERNIERS

The five-inch vertical circle may be arranged as shown in No. 138, to be read by two opposite double verniers to one minute. The verniers are supported on a ribbed frame fastened with the circle to a flange in such a manner that the circle is concentric with the frame, and the verniers read accurately in any position of the circle.

The frame is arranged with an adjusting-screw, to bring the verniers into exact adjustment with the level on telescope.

PRICES OF VERTICAL CIRCLES

No.			
135	3½-inch	Vertical Circle	\$ 8.00
136	4½-inch	“ “	12.00
137	5 -inch	“ “	15.00
138	5 -inch	“ “ with two opposite double verniers	35.00

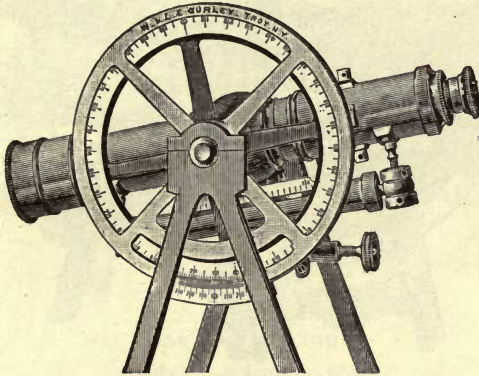

No. 141

ALUMINUM GUARD FOR VERTICAL CIRCLE

Price, \$6.00.

For protecting the graduated edge of the vertical circle we make an improved guard, as shown in No. 141. This guard is of aluminum, finely finished, and so mounted on the standard as to be concentric with the circle. We can furnish this guard for all sizes of vertical circles which we make.

VERTICAL ARC

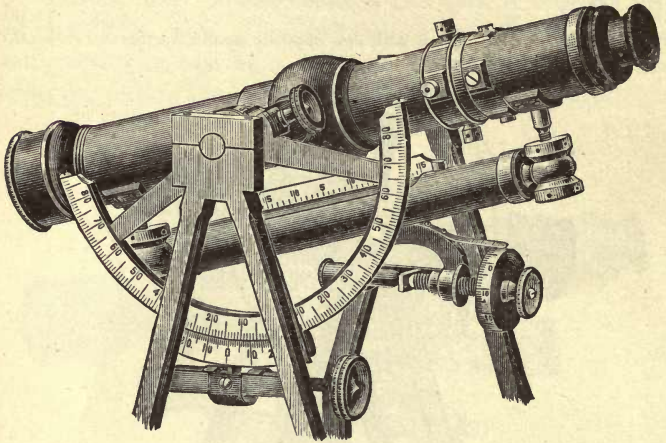

NOS. 139 AND 140

Price, \$18.00

The vertical arc is made in two sizes, of two and one-half and three inches radius, graduated on silver and read by a vernier swung from the axis and movable by a tangent screw.

The arc is movable around its bearing on the axis, and can be readily clamped at zero with the vernier in any position of the telescope, and any degree of elevation can be read off directly on the arc.

The arc of two and one-half inches radius is generally used on the Light Mountain Transit, and reads by its vernier to single minutes, while the arc of three inches radius is commonly used on the larger transits, and reads by the vernier to thirty seconds. The vertical arc can be readily attached to any transit of our manufacture.

*LEVEL ON TELESCOPE AND CLAMP AND
TANGENT TO TELESCOPE AXIS*

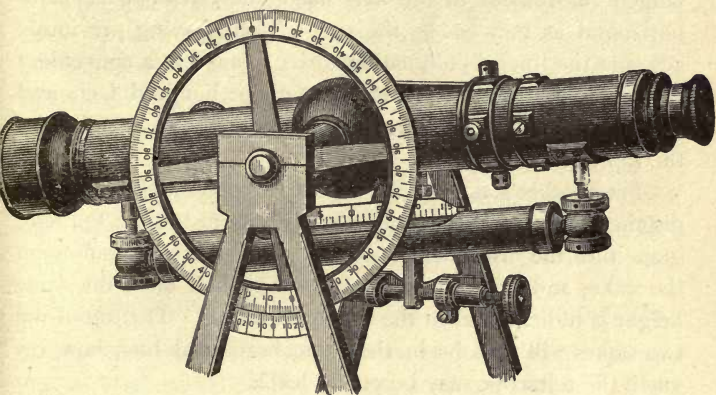

NOS. 145 AND 148

Price of Level on Telescope, \$12.00.

The level on telescope, No. 145, consists of a brass tube about six and one-half inches long, each end of which is held between two capstan nuts connected with a screw or stem attached to the under side of the telescope tube.

The vial enclosed in the tube is a little over five inches long and half an inch in diameter, and is ground on its inner surface so as to insure an even and sensitive bubble, the length of which is measured by the scale above. The scale is graduated to tenths of an inch, and is figured from 0 at the middle to 5, 10, 15, on either side, thus determining when the bubble is brought into the middle of its run.

To adjust the level on telescope: When the vernier of
ADJUSTMENT the vertical circle is adjusted, as on page 55,
 and is at zero, the line of collimation is
 level and the bubble may be brought into the middle of its

run by the capstan-head nuts. Another method is as follows: First level the instrument carefully, and with the clamp and tangent movement to the axis make the telescope as nearly horizontal as may be, by the eye. Then, having previously adjusted the line of collimation, drive a stake at a convenient distance, say from one hundred to three hundred feet, and note the height cut by the horizontal wire upon a staff set at the top of the stake.

Fix another stake in the opposite direction and at the same distance from the instrument, and without disturbing the telescope turn the instrument upon its spindle, set the staff upon the stake, and drive the stake into the ground until the same height is indicated as in the first observation. The top of the two stakes will then be in the same horizontal line, however much the telescope may be out of level.

Remove the instrument from fifty to one hundred feet to one side of either of the stakes and in line with both. Again level the instrument, clamp the telescope as nearly horizontal as may be, and note the heights indicated upon the staff placed first upon the nearest and then upon the most distant stake. If both agree, the telescope is level. If they do not agree, with the tangent screw move the wire over nearly the whole error, as shown at the distant stake, and repeat the operation just described. Proceed thus until the horizontal wire will indicate the same height at both stakes, when the telescope will be truly horizontal. Taking care not to disturb the position of the telescope, bring the bubble into the middle by the little leveling-nuts at the end of the tube, when the adjustment will be complete.

CLAMP AND TANGENT

Price, \$6.00

The clamp and tangent, No. 148, consists of an arm at one end encircling the telescope axis, and at the other end connected with the tangent screw. The clamp is fastened at will to the axis by a clamp screw inserted at one side of the ring, and by turning the tangent screw the telescope may be raised or lowered.

The clamp and tangent must always accompany the vertical circle and level on telescope, whenever either is used on a transit.

SIGHTS ON TELESCOPE AND ON STANDARDS

For convenience in observation, we occasionally place a pair of small sights on the telescopes of our transits. These sights have folding joints, that they may lie close to the telescope when not in use. Sights may also be placed on the standards at an angle of ninety degrees with the telescope, for use in offsetting.

Price of either pattern, per pair..... \$8.00

ATTACHED MAGNIFIERS

Attached magnifiers are frequently used over the verniers of the horizontal or vertical limb, and are held by a universal three-jointed arm, which allows the lens to be placed over any point of the vernier.

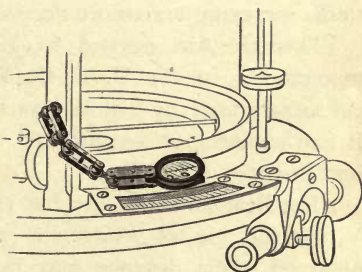

Price of Attached Magnifiers, each..... \$5.00

BEAMAN STADIA ARC

Patented March 27, 1906

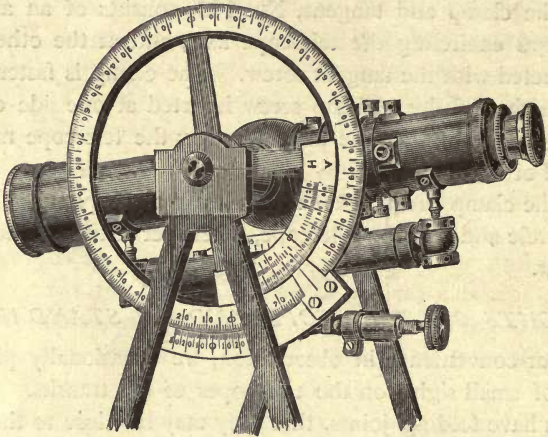

No. 149

This new and specially graduated vertical arc furnishes engineers with a rapid and exact mechanical solution of the stadia problem, since by its use precise differences in elevation, and reduced horizontal distances, can be determined with great rapidity, without the use of any of the adjuncts in stadia surveying heretofore necessary.

This arc was devised in 1904 by W. M. Beaman, a topographer in the U. S. Geological Survey, and is now extensively used by that bureau in its topographical surveys. It can replace, or be attached to, the vertical arc of any instrument.

The Beaman stadia arc has two scales: a multiple scale, V, by the use of which the grade per hundred feet of observed stadia distance may be determined, and a reduction scale, H, giving the percentage of correction necessary

to reduce observed stadia distance to true horizontal distance.

We furnish this stadia arc attached to the vertical limbs of new transits or telescopic alidades, or fit it to any instrument sent to us for that purpose. The price of the arc, when fitted to an old instrument, will depend on the cost of attaching, and will be quoted after examination of the instrument.

ADVANTAGES OF THE STADIA ARC

1. The use of stadia tables, slide-rules, or diagrams is entirely obviated.
2. There is no vernier or similar contrivance to be read.
3. Final results are obtained in less than one-third the time required by ordinary methods.
4. The accuracy of results is identical with formulæ or table computations, regardless of the angle or distance.
5. The simplicity of the process practically eliminates the chances of error incidental to the use of other methods.

A more detailed description of the Beaman stadia arc and its use, as well as a general discussion of the subject of stadia surveying, is found in the special pamphlet on Stadia Surveying which we publish, and which we furnish free of charge on application.

GRADIENTER

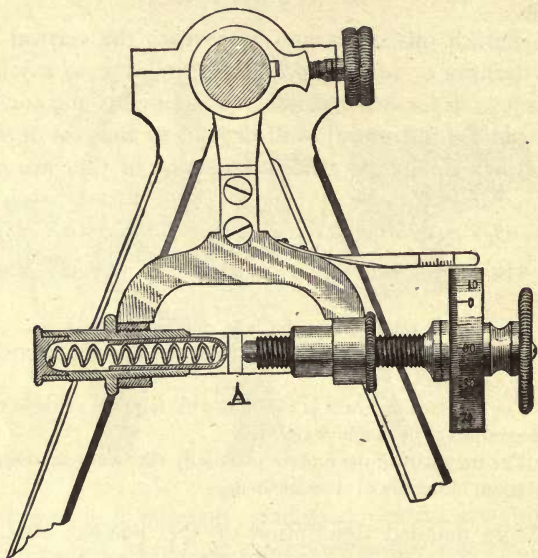

No. 150

Price, as shown, \$18.00.

This attachment is often used with the transit for determining distances, fixing grades and similar work.

It consists mainly of a screw attached to the expanded arm of the ordinary clamp of the telescope axis. This screw is accurately cut, and, passing through a nut in one side of the arm, presses against a stud, A, fixed to the inside surface of the right-hand standard. In the side of the arm opposite the screw is an enclosed spiral spring which presses against the side of the stud, thus securing a positive movement of the gradienter screw.

Near the other end of the screw, and turning with it, is a

wheel or micrometer, the rim of which is covered with silver, and graduated into one hundred equal parts. A silver scale, attached to the arm and just above the micrometer wheel, is graduated into spaces, each of which is equal to one revolution of the screw; so that by comparing the edge of the wheel with the graduations of the scale, the number of complete revolutions of the screw can be easily counted.

When the clamp is made fast to the axis, the gradienter screw will serve as an ordinary tangent screw to incline the telescope. As the value of its screw thread is such that a complete revolution of the screw will move the horizontal cross-wire of the telescope over a space of one foot on a vertical rod at a distance of one hundred feet, it is clear that when the screw is turned through fifty spaces on the graduated head, the wire will pass over fifty-hundredths, or one-half a foot on the rod, and so on in the same proportion. In this way the gradienter can be used in the measurement of distances.

To avoid any possibility of error, it is advisable that observations should not be taken by a reversal of the screw.

Grades can be established with great facility as follows: Level the instrument, and bring the telescope level-bubble to the middle by the clamp and gradienter screw. Move the graduated head until its zero is brought to the edge of the scale; then turn off as many spaces on the head as there are hundredths of feet to the hundred in the grade to be established.

DETACHABLE TELESCOPES FOR VERTICAL SIGHTING

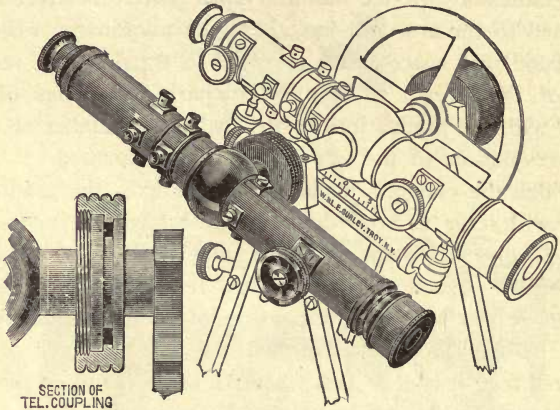

No. 160

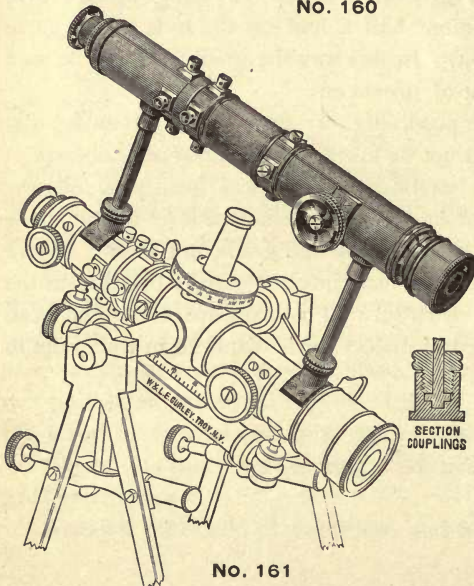

No. 161

A convenient arrangement for sighting up or down a vertical shaft is shown in No. 160, in which an extra telescope is fitted with a flange and disk connecting it with the axis, so as to make it precisely parallel with the main telescope. A counterpoise, as shown, is

fitted to the other end of the axis, and both telescope and counterpoise can be detached and placed in the transit box when not in use.

In No. 161, the extra telescope is connected with the main telescope by coupling-nuts, which fasten it directly over the center of the instrument and allow its ready removal and replacement without disturbing its adjustments. In both arrangements the extra telescope is adjusted to the main telescope of the transit so that the lines of collimation of both are parallel and in the same plane, horizontal in No. 160 and vertical in No. 161; and in both the extra telescope swings over the outside of the transit plates. The diagonal prism is often used with the extra telescope for greater convenience in sighting.

Price of either Telescope, No. 160 or No. 161 \$25.00

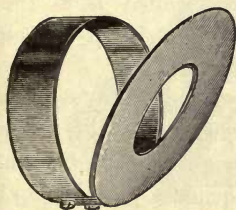

NOS. 165 AND 166
REFLECTOR
Prices, \$4.00 and \$5.00.

The reflector, Nos. 165 and 166, is an elliptical piece of silver inclined at an angle of forty-five degrees with its ring, which is fitted to the objective end of the telescope. The opening in the reflector allows the use of the telescope, while a light held near the inner surface illuminates the cross-wires.

(See page 275.)

The diagonal prism, No. 168, is used when it is necessary to observe greater

DIAGONAL vertical angles than can be
PRISM taken with the ordinary tele-

scope. It consists of a prism attached to the cap of the eyepiece, by which the object is presented to the eye when placed at right angles with the telescope. When

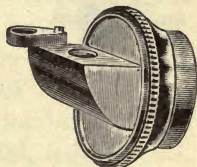

NO. 168
DIAGONAL PRISM
Price, \$8.00.

the telescope is directed to the sun the slide or darkener containing colored glass is moved over the opening.

The circular plate to which the prism is attached is made to turn in the cap, so that, when it is substituted for the ordinary cap of the eyepiece, the opening of the prism can be easily adjusted to the position of the eye. Observations can be taken with the prism up to an angle of sixty degrees elevation.

The Plummet Lamp, No. 170, is a large

PLUMMET LAMP plummet, of which the upper part is hollow to contain oil.

It has a tube for a wick, and an extinguisher.

It is hung in gimbals by chains with a hook, and so always assumes a vertical position, and when suspended from the shifting center of a leveling-head it can be easily adjusted over a given point.

These lamps are packed in a wooden case, furnished with a strap to sling over the shoulders. The weight of each lamp is about one and one-quarter pounds, and either one, two, or three may be packed in each box, as desired.



NO. 170
PLUMMET LAMP
Price, \$10.00

SOLAR ATTACHMENT

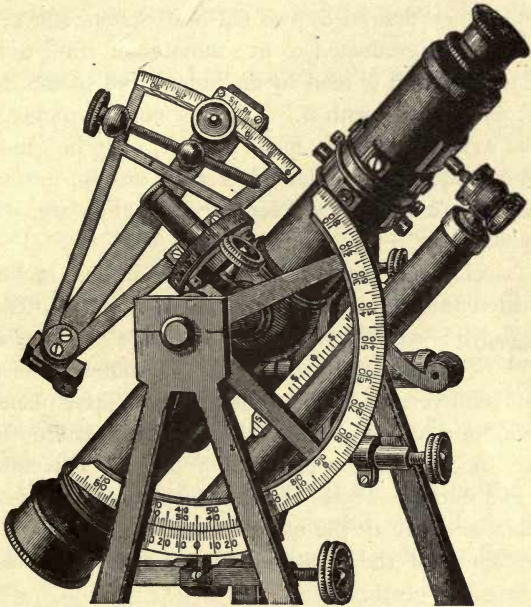

NO. 190

Price, \$60.00.

THE solar attachment is essentially the solar apparatus of Burt placed upon the cross-bar of the transit. A disk one and one-half inches in diameter, having a pivot projecting above its upper surface, is screwed to the telescope axis. Upon this pivot rests the enlarged base of the polar axis, which is firmly connected with the disk by four capstan-head screws passing from the under side of the disk into the base. These screws serve to adjust the polar axis, as will be explained hereafter.

The hour circle surrounding the base of the polar axis is easily movable about it, and can be fastened at any point desired by two flat-head screws above. It is graduated to five minutes of time, is figured from I to XII, and is read by an index fixed to the declination arc and moving with it. A hollow cone or socket, fitting the polar axis and made to move upon it, or to be clamped at any point desired by a milled-head screw on top, furnishes by its arms below a firm support for the declination arc, which is fastened to it.

The declination arc has a radius of about five inches, and is graduated to quarter-degrees. On the Mountain Transit it reads by its vernier to single minutes, and on the larger transits to half-minutes, the graduations of both vernier and limb being in the same plane. The declination arc has the usual lenses and silver plate on the two opposite blocks, also a clamp and tangent movement, as shown in the cut. The arc of the declination limb is turned on its axis and one or the other solar lens used, as the sun is north or south of the equator. The cut shows its position when the sun is north.

The latitude is set off by means of a large vertical limb figured from the center each way in two rows, from 0 to 80 and from 90 to 10, the first series being intended for reading vertical angles, and the second series for setting off the latitude. The vernier of the vertical limb is made movable by the tangent screw attached, so that its zero and that of the limb are readily made to coincide when, in adjusting the limb to the level of the telescope, the arc is clamped to the axis.

The usual tangent movement to the telescope axis serves to incline the telescope to the proper angle, as hereafter

described. A level on the under side of the telescope, with ground vial and a scale, is indispensable in the use of the solar attachment. The arcs, verniers, and hour circle are all graduated on silver.

See pages 97 to 102 for definitions of astronomical terms.

EXPLANATION OF THE SOLAR ATTACHMENT

In the engraving on page 72 we have a graphic illustration of the solar apparatus, the circles shown representing those supposed to be drawn upon the concave surface of the heavens.

When the telescope is set horizontal by its spirit level, the hour circle will be in the plane of the horizon, the polar axis will point to the zenith, and the zeros of the vertical arc and its vernier will coincide. If we incline the telescope, directed north as shown in the cut, the polar axis will descend from the direction of the zenith. The angle through which it moves, being laid off on the vertical arc, will be the co-latitude of the place where the instrument is used, the latitude itself being found by subtracting this number from ninety degrees.

When the sun passes above or below the equator, its declination, or angular distance from it, as given in the Ephemeris, can be set off upon the declination arc, and its image brought into position as before.

In order to do this, however, it is necessary not only that the latitude and declination be correctly set off upon their respective arcs, but also that the instrument be moved in azimuth until the polar axis points to the pole of the heavens, or, in other words, is placed in the plane of the meridian. Thus the position of the sun's image will indicate not only the latitude of the place, the declination of the sun for the

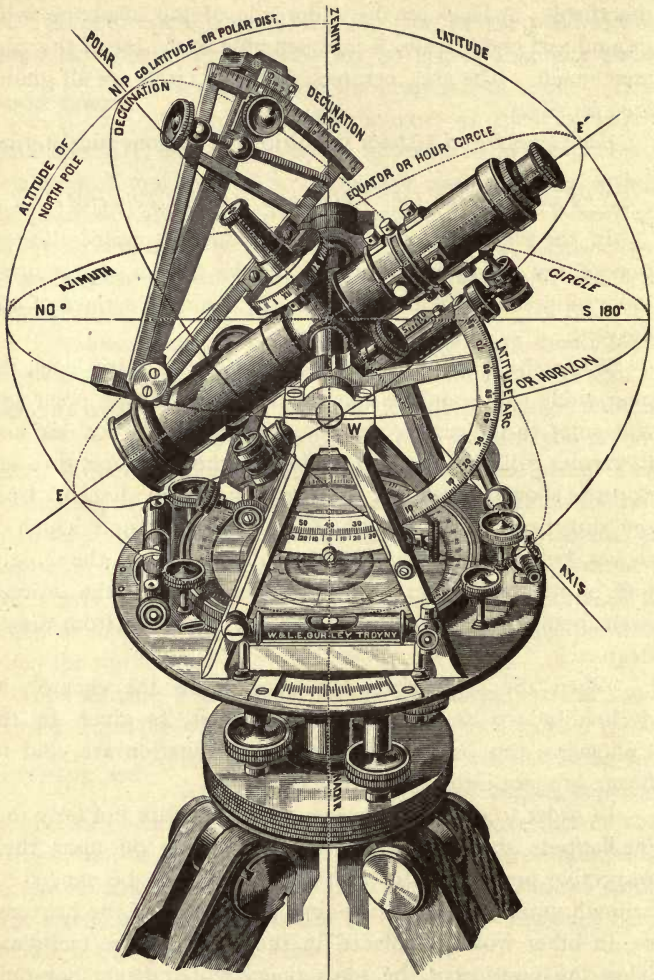

GRAPHIC ILLUSTRATION OF THE SOLAR APPARATUS

given hour, and the apparent time, but it will also determine the meridian, or true north and south line passing through the place where the observation is made.



The interval between two equatorial lines, cc , as well as between the hour lines, bb , is just sufficient to include the circular image of the sun, as formed by

the solar lens on the opposite end of the revolving arm.

DECLINATION Allowance for declination: Let us now suppose the observation made when the sun has passed the equinoctial point, and when its position is affected by declination.

By referring to the Ephemeris, and setting off on the arc the declination for the given day and hour, we are still able to determine its position with the same certainty as if it remained on the equator.

When the sun's declination is south, that is, from the 22d of September to the 20th of March in each year, the arc is turned downward, or toward the plates of the transit, while during the remainder of the year the arc is turned from the plates.

When the solar attachment is accurately adjusted and the transit plates precisely horizontal, the latitude of the place and the declination of the sun for the given day and hour being set off on their respective arcs, and the instrument set approximately north by the magnetic needle, the image of the sun cannot be brought between the equatorial lines until the polar axis is placed in the plane of the meridian of the place, or in a position parallel with the axis of the earth. The slightest deviation from this position will cause the image to pass above or below the lines, and thus discover the error.

From the position of the sun in the solar system we thus

obtain a direction absolutely unchangeable, from which to run lines and measure horizontal angles.

This simple principle is not only the basis of the construction of solar instruments, but it is the sole cause of their superiority over instruments having only the magnetic needle. For in an instrument having a magnetic needle, the accuracy of the horizontal angles indicated, and therefore of all the observations made, depends upon the delicacy of the needle and the constancy with which it assumes a certain direction, called the magnetic meridian.

The principal causes of error in the needle are the dulling of the pivot and the resulting injury to the jeweled center, loss of polarity in the needle, the influence of local attraction, and the effect of the sun's rays producing the diurnal variation. From all these imperfections the solar instrument is free.

The latitude of the place and the declination of the sun being set off upon their respective arcs, we are able not only to run the true meridian, or a due east and west course, but also to set off horizontal angles with minuteness and accuracy from a direction which never changes and which is unaffected by attraction.

ADVANTAGES OF THE SOLAR ATTACHMENT

From what has been said, the surveyor will readily understand that the more perfect horizon obtained by the use of the telescope level, and the use of a telescope in place of sights, render the attachment more accurate than the Solar Compass.

The attachment can be added to the telescope of any good transit at a comparatively small cost, thus enabling the surveyor to establish the true meridian, to determine the correct latitude, and to obtain true time very nearly.

Its adaptation to the purposes of illustration and instruction in practical astronomy in colleges and schools will occur to every teacher; and it furnishes for the government surveyor a long-sought and much-needed instrument, superior to the Solar Compass formerly used.

In experiments made by us, an error of one-quarter of a minute in the direction of the true meridian, or in latitude, could be easily detected by observing the sun's image through a magnifier, and we feel confident that any one who uses the solar attachment will be satisfied with its work.

The weight of the solar attachment is but little more than ten ounces, and is so distributed as not to disturb the counterpoise of the instrument, thus obviating the objection which has hitherto prevented the successful use of the telescope with the solar apparatus. When not in use the attachment should be removed from the telescope and packed in the instrument case, and the thin sheath put on the polar axis and kept in its place by the screw and washer of the socket.

It is evident that all transits to which the solar attachment is to be added should have a horizontal limb and verniers, and should be furnished with a level on telescope, clamp and tangent to telescope axis, and vertical arc and vernier. They should also have a movable compass circle to set off the magnetic declination, and should be leveled by leveling-screws. They must be in perfect order, especially in respect to the sockets, before correct work can be done.

TO RUN LINES WITH THE SOLAR ATTACHMENT

Having set off the latitude of the place on the vertical arc, and the declination, corrected for refraction, for the given day and hour as computed from the tables in the Solar Ephemeris, the instrument being also carefully leveled by the telescope bubble, set the horizontal limb at zero and clamp the plates. Loosen the lower screw so that the transit moves easily upon its lower socket, set the instrument approximately north and south, with the objective end of the telescope toward the north, turn the proper solar lens to the sun, and, with one hand on the plates and the other on the revolving arm, move them from side to side until the sun's image is brought between the equatorial lines on the silver plate.

The lower clamp of the instrument should now be fastened, and any further lateral movement be made by the tangent screw of the leveling-head. The telescope will now be in the true meridian, and may be used like the sights of the Solar Compass, but with far greater accuracy and satisfaction in establishing meridian lines. When the upper or vernier plate is unclamped from the limb, an angle read by the verniers is an angle from the meridian; and thus parallels of latitude or any other angles from the true meridian may be established, as with the Solar Compass.

The bearing of the needle, when the telescope is on the meridian, will also give the magnetic declination at the point of observation.

If the instrument has a movable compass circle, as in our Surveyors' Transits, the magnetic declination can be set off to single minutes, the needle kept at zero, or with the sun, and lines be run by the needle alone when the sun is obscured.

REFRACTION IN DECLINATION

The Table of Refractions on pages 78 to 82 is calculated for latitudes between $2\frac{1}{2}^{\circ}$ and 70° at intervals of $2\frac{1}{2}^{\circ}$, that being as near as is required.

The declination ranges from 0° to 20° both north and south, the + declinations being north and the — south, and is given for every 5° , that being sufficiently near for all practical purposes. The hour angle in the first column indicates the distance of the sun from the meridian in hours, the refraction given for 0 hours being that which affects the observed declination of the sun when on the meridian, commonly known as meridional refraction. The refraction for the hour just before or after noon is so nearly that of the meridian that it may be called and allowed as the same.

When the table is used, it must be borne in mind that when the declination is north, or + in the table, the refraction is to be added; when the declination is south, or —, the refraction must be subtracted. It will be noticed that the refraction in south, or —, declination increases very rapidly as the sun nears the horizon, showing that observations should not be taken with the sun when it is south of the equator, less than one hour from the horizon.

*A TABLE OF MEAN REFRACTIONS IN
DECLINATION*

To apply on the declination arc of solar attachment of either compasses or transits.

Computed by EDWARD W. ARMS, C. E., for W. & L. E. GURLEY, Troy, N. Y.

HOUR ANGLE	DECLINATIONS								
	FOR LATITUDE 2° 30'								
	+20°	+15°	+10°	+5°	0°	-5°	-10°	-15°	-20°
0 h.	-18"	-12"	-07"	-02"	+02"	07"	12"	18"	23"
2	-18	-12	-07	-02	+02	07	12	18	23
3	-17	-11	-06	-01	+03	08	13	19	25
4	-15	-10	-05	0	+05	10	15	21	27
5	-10	-05	0	+05	10	15	20	26	32

FOR LATITUDE 5°

0 h.	-15"	-10"	-05"	0"	+05"	10"	15"	20"	27"
2	-15	-10	-05	0	+05	10	15	20	27
3	-13	-08	-03	+02	07	12	17	23	29
4	-10	-05	0	+05	10	15	20	27	32
5	-05	0	+05	10	15	20	27	32	40

FOR LATITUDE 7° 30'

0 h.	-13"	-08"	-02"	+02"	08"	13"	18"	24"	29"
2	-12	-07	-01	+03	09	14	19	25	31
3	-10	-05	0	+05	10	15	20	26	32
4	-05	0	+05	10	15	20	26	32	39
5	+07	12	17	23	29	36	43	51	1'01

FOR LATITUDE 10°

0 h.	-10"	-05"	0"	+05"	10"	15"	20"	26"	32"
2	-07	-03	+02	07	12	17	22	28	34
3	-05	0	+03	08	13	19	25	31	38
4	0	05	10	15	20	26	32	39	46
5	+15	20	26	32	39	46	55	1'06	1'19

FOR LATITUDE 12° 30'

0 h.	-08"	-02"	+02"	8"	13"	18"	24"	30"	36"
2	-06	00	+05	10	15	20	26	32	39
3	+02	07	12	17	23	29	36	43	51
4	04	09	14	20	25	31	40	48	55
5	21	27	33	40	48	57	1'08	1'23	1'41

HOUR ANGLE	DECLINATIONS								
	FOR LATITUDE 15°								
	+20°	+15°	+10°	+5°	0°	-5°	-10°	-15°	-20°
0 h.	-05"	0"	+05"	10"	15"	21"	27"	33"	40"
2	-03	+02	07	12	18	23	29	36	43
3	+01	05	11	16	22	28	34	41	49
4	08	12	19	24	30	37	44	53	1'04
5	29	34	41	49	59	1'10	1'24	1'43	2 08

FOR LATITUDE 17° 30'

0 h.	-02"	+02"	08"	13"	18"	24"	30"	36"	44"
2	0	05	10	15	21	27	33	40	48
3	+02	10	15	21	27	33	40	48	57
4	13	18	23	29	35	43	51	1'01	1'13
5	34	41	49	58	1'10	1'23	1'41	2 06	2 42

FOR LATITUDE 20°

0 h.	0"	05"	10"	15"	21"	27"	33"	40"	48"
2	03	07	13	18	24	30	36	44	52
3	06	13	18	24	30	36	44	52	1'02
4	17	22	28	35	42	50	1'00	1'11	1 26
5	39	47	57	1'07	1'20	1'37	2 00	2 32	3 25

FOR LATITUDE 22° 30'

0 h.	02"	08"	13"	18"	24"	30"	36"	44"	52"
2	06	11	15	21	27	33	40	48	57
3	11	15	21	27	33	40	48	57	1'08
4	20	26	32	39	46	56	1'07	1'19	1 37
5	45	53	1'03	1'16	1'31	1'52	2 21	3 07	4 28

FOR LATITUDE 25°

0 h.	05"	10"	15"	21"	27"	33"	40"	48"	57"
2	08	14	19	25	31	38	46	54	1'05
3	12	18	24	30	37	44	53	1'04	1 18
4	23	29	35	45	53	1'03	1'16	1 31	1 52
5	49	59	1'10	1'24	1'52	2 07	2 44	3 46	5 43

FOR LATITUDE 27° 30'

0 h.	08"	13"	18"	24"	30"	36"	44"	52"	1'02"
2	11	16	22	28	34	41	49	1'00	1 10
3	17	22	28	35	42	50	1'00	1 11	1 26
4	28	35	42	50	1'00	1'11	1 26	1 43	2 09
5	54	1'05	1'18	1'34	1 54	2 24	3 11	4 38	8 15

FOR LATITUDE 30°

0 h.	10"	15"	21"	27"	33"	40"	48"	57"	1'08"
2	14	19	25	31	38	46	54	1'05	1 18
3	20	26	32	39	47	55	1'06	1 19	1 36
4	32	39	46	52	1'06	1'19	1 35	1 57	2 29
5	1'00	1'10	1'24	1'52	2 07	2 44	3 46	5 43	13 06



HOUR ANGLE	DECLINATIONS								
	FOR LATITUDE 32° 30'								
	+20°	+15°	+10°	+5°	0°	-5°	-10°	-15°	-20°
0 h.	13"	18"	24"	30"	36"	44"	52"	1'02"	1'14"
2	17	22	28	35	42	50	1'00	1 11	1 26
3	23	29	35	43	51	1'01	1 13	1 28	1 47
4	35	43	51	1'01	1'13	1 27	1 46	2 13	2 54
5	1'03	1'15	1'31	1 53	2 20	3 05	4 25	7 36	
FOR LATITUDE 35°									
0 h.	15"	21"	27"	33"	40"	48"	57"	1'08"	1'21"
2	20	25	32	38	46	55	1'05	1 18	1 35
3	26	33	39	47	56	1'07	1 21	1 38	2 00
4	39	47	56	1'07	1'20	1 36	1 59	2 32	3 25
5	1'07	1'20	1'38	2 00	2 34	3 29	5 14	10 16	
FOR LATITUDE 37° 30'									
0 h.	18"	24"	30"	36"	44"	52"	1'02"	1'14"	1'29"
2	22	28	35	42	50	1'00	1 12	1 26	1 45
3	29	36	43	52	1'02	1 14	1 29	1 49	2 16
4	43	51	1'01	1'13	1 27	1 49	2 14	2 54	4 05
5	1'11	1'26	1 54	2 10	2 49	3 55	6 15	14 58	
FOR LATITUDE 40°									
0 h.	21"	27"	33"	40"	48"	57"	1'08"	1'21"	1'39"
2	25	32	39	46	52	1'06	1 19	1 35	1 57
3	33	40	48	57	1'08	1 21	1 38	2 02	2 36
4	47	55	1'06	1'19	1 36	1 58	2 30	3 21	4 59
5	1'15	1'31	1 51	2 20	3 05	4 25	7 34	25 18	
FOR LATITUDE 42° 30'									
0 h.	24"	30"	36"	44"	52"	1'02"	1'14"	1'29"	1'49"
2	28	35	39	50	1'00	1 12	1 26	1 45	2 11
3	36	43	52	1'02	1 13	1 29	1 49	2 17	2 59
4	50	1'00	1'11	1 26	1 44	2 19	2 49	3 55	6 16
5	1'19	1 36	1 58	2 30	3 22	5 00	9 24		
FOR LATITUDE 45°									
0 h.	27"	33"	40"	48"	57"	1'08"	1'21"	1'39"	2'02"
2	32	39	46	52	1'06	1 19	1 35	1 57	2 29
3	40	47	56	1'07	1 21	1 38	2 00	2 34	3 29
4	54	1'04	1'16	1 33	1 54	2 24	3 11	4 38	8 15
5	1'23	1 41	2 05	2 41	3 40	5 40	12 02		
FOR LATITUDE 47° 30'									
0 h.	30"	36"	44"	52"	1'02"	1'14"	1'29"	1'49"	2'18"
2	35	42	50	1'00	1 12	1 26	1 45	2 01	2 51
3	43	51	1'01	1 13	1 28	1 47	2 15	2 56	4 08
4	56	1'09	1 23	1 40	2 05	2 40	3 39	5 37	11 18
5	1'27	1 46	2 12	2 52	4 01	6 30	16 19		

HOUR ANGLE	DECLINATIONS								
	FOR LATITUDE 50°								
	+20°	+15°	+10°	+5°	0°	-5°	-10°	-15°	-20°
0 h.	33"	40"	48"	57"	1'08"	1'21"	1'39"	2'02"	2'36"
2	38	46	55	1'06	1 18	1 35	1 57	2 28	3 19
3	47	56	1'06	1 19	1 36	2 29	2 31	3 23	5 02
4	1'02	1'14	1 29	1 48	2 16	2 58	4 18	6 59	19 47
5	1 30	1 51	2 19	3 04	4 22	7 28	24 10		
FOR LATITUDE 52° 30'									
0 h.	36"	44"	52"	1'02"	1'14"	1'29"	1'49"	2'18"	3'05"
2	43	50	59	1 11	1 26	1 42	2 23	2 49	3 55
3	50	1'00	1'11	1 26	1 45	2 11	2 51	2 58	6 22
4	1'05	1'18	1 35	2 10	2 28	3 19	4 53	8 42	
5	1 34	1 56	2 27	3 16	4 47	8 52			
FOR LATITUDE 55°									
0 h.	40"	48"	57"	1'08"	1'21"	1'39"	2'02"	2'36"	3'33"
2	46	55	1'05	1 18	1 34	1 56	2 30	3 15	4 47
3	55	1'06	1 19	1 35	1 58	2 30	3 21	4 58	9 19
4	1'10	1 23	1 42	2 06	2 43	3 44	5 49	12 41	
5	1 37	2 01	2 34	3 28	5 15	10 18			
FOR LATITUDE 57° 30'									
0 h.	44"	52"	1'02"	1'14"	1'29"	1'49"	2'18"	3'05"	4'37"
2	50	59	1 11	1 25	1 43	2 09	2 47	3 51	6 04
3	58	1'10	1 24	1 42	2 07	2 43	3 45	5 50	12 47
4	1'11	1 25	1 43	2 10	2 50	3 55	6 14	14 49	
5	1 41	2 06	2 42	3 42	5 46	12 26			
FOR LATITUDE 60°									
0 h.	48"	57"	1'08"	1'21"	1'39"	2'02"	2'36"	3'33"	5'23"
2	54	1'04	1 17	1 33	1 54	2 24	3 12	4 38	8 15
3	1'03	1 15	1 30	1 51	2 20	3 04	4 24	7 31	24 44
4	1 18	1 34	1 56	2 28	3 18	4 50	8 53		
5	1 45	2 11	2 50	3 57	6 21	15 32			
FOR LATITUDE 62° 30'									
0 h.	52"	1'02"	1'14"	1'29"	1'50"	2'18"	3'00"	4'17"	7'13"
2	58	1 09	1 23	1 41	2 06	2 43	3 44	5 50	12 44
3	1'07	1 23	1 38	2 01	2 35	3 30	5 16	10 24	
4	1 23	1 40	2 05	2 40	3 40	5 37	11 50		
5	1 48	2 17	2 59	4 14	7 03				
FOR LATITUDE 65°									
0 h.	57"	1'08"	1'21"	1'39"	2'02"	2'36"	3'33"	5'23"	10'51"
2	1'03	1 16	1 31	1 52	2 21	3 07	4 28	7 44	
3	1 12	1 27	1 46	2 12	2 52	4 02	6 33		
4	1 27	1 47	2 13	2 54	4 05	6 40			
5	1 52	2 22	3 08	4 30	7 52				

HOUR ANGLE	DECLINATIONS								
	FOR LATITUDE 67° 30'								
	+20°	+15°	+10°	+5°	0°	-5°	-10°	-15°	-20°
0 h.	1'02"	1'14"	1'29"	1'50"	2'18"	3'00"	4'17"	7'13"	
2	1 08	1 22	1 40	2 03	2 39	3 37	5 32	11 28	
3	1 17	1 34	1 55	2 26	3 14	4 44	8 34		
4	1 32	1 53	2 23	3 14	4 35	8 05			
5	1 56	2 28	3 17	4 40	8 51				
FOR LATITUDE 70°									
0 h.	1'08"	1'21"	1'39"	2'02"	2'36"	3'33"	5'23"	10'51"	
2	1 14	1 29	1 50	2 18	3 00	4 17	7 13		
3	1 23	1 43	2 05	2 41	3 41	5 59	12 15		
4	1 37	2 00	2 34	3 28	5 20	10 12			
5	2 02	2 33	3 27	5 11	10 05				

TO COMPUTE THE DECLINATION

Suppose the corrected declination is desired for the different hours of February 15, 1905, at Troy, N. Y. The latitude is $42^{\circ} 44'$. The longitude is practically five hours; so that the declination given in the Ephemeris for apparent noon of that day at Greenwich would be that for 7 A. M. at Troy, or five hours earlier. Note carefully the algebraic signs. The declination is South or minus. Its hourly difference is plus. The refraction always is plus. Hence we use the algebraic sum, thus:—

S $12^{\circ} 47' 57''.5$	is the tabular declination for	7 A. M.
$51''.3$	Sub. hr. dif.	
<hr/>		
$-12^{\circ} 47' 6''.2$	+ ref. (4 hrs.) $3' 21''$	= $-12^{\circ} 43' 45''$, 8 A. M.
$51''.3$		
<hr/>		
$-12^{\circ} 46' 14''.9$	+ ref. (3 hrs.) $2' 02''$	= $-12^{\circ} 44' 13''$, 9 A. M.
$51''.3$		
<hr/>		
$-12^{\circ} 45' 23''.6$	+ ref. (2 hrs.) $1' 35''$	= $-12^{\circ} 43' 49''$, 10 A. M.
$51''.3$		
<hr/>		
$-12^{\circ} 44' 32''.3$	+ ref. (1 hr.) $1' 20''$	= $-12^{\circ} 43' 12''$, 11 A. M.
$51''.3$		
<hr/>		
$-12^{\circ} 43' 41''.0$	+ ref. (0 hr.) $1' 20''$	= $-12^{\circ} 42' 21''$, 12 M.
$51''.3$		
<hr/>		
$-12^{\circ} 42' 49''.7$	+ ref. (1 hr.) $1' 20''$	= $-12^{\circ} 41' 30''$, 1 P. M.
$51''.3$		
<hr/>		
$-12^{\circ} 41' 58''.4$	+ ref. (2 hrs.) $1' 35''$	= $-12^{\circ} 40' 23''$, 2 P. M.
$51''.3$		
<hr/>		
$-12^{\circ} 41' 07''.1$	+ ref. (3 hrs.) $2' 02''$	= $-12^{\circ} 39' 05''$, 3 P. M.
$51''.3$		
<hr/>		
$-12^{\circ} 40' 15''.8$	+ ref. (4 hrs.) $3' 21''$	= $-12^{\circ} 36' 55''$, 4 P. M.

Again, suppose the corrected declination is desired for the different hours of May 15, 1905, at Troy. Now the declination is North or plus and the hourly difference is plus.

$$\begin{array}{r} \text{N } 18^{\circ} 46' 14''.9 \\ \hline \text{35''.7} \end{array} + \text{ ref. (5 hrs.) } 1' 24'' = 18^{\circ} 47' 39'', \text{ 7 A. M.} \\ \text{35''.7 Add hr. dif.}$$

$$\begin{array}{r} 18^{\circ} 46' 50''.6 \\ \hline \text{35''.7} \end{array} + \text{ ref. (4 hrs.) } 54'' = 18^{\circ} 47' 45'', \text{ 8 A. M.}$$

$$\begin{array}{r} 18^{\circ} 47' 26''.3 \\ \hline \text{35''.7} \end{array} + \text{ ref. (3 hrs.) } 39'' = 18^{\circ} 48' 05'', \text{ 9 A. M.}$$

$$\begin{array}{r} 18^{\circ} 48' 02''.0 \\ \hline \text{35''.7} \end{array} + \text{ ref. (2 hrs.) } 30'' = 18^{\circ} 48' 32'', \text{ 10 A. M.}$$

$$\begin{array}{r} 18^{\circ} 48' 37''.7 \\ \hline \text{35''.7} \end{array} + \text{ ref. (1 hr.) } 26'' = 18^{\circ} 49' 04'', \text{ 11 A. M.}$$

$$\begin{array}{r} 18^{\circ} 49' 13''.4 \\ \hline \text{35''.7} \end{array} + \text{ ref. (0 hr.) } 26'' = 18^{\circ} 49' 39'', \text{ 12 M.}$$

$$\begin{array}{r} 18^{\circ} 49' 49''.1 \\ \hline \text{35''.7} \end{array} + \text{ ref. (1 hr.) } 26'' = 18^{\circ} 50' 15'', \text{ 1 P. M.}$$

$$\begin{array}{r} 18^{\circ} 50' 24''.8 \\ \hline \text{35''.7} \end{array} + \text{ ref. (2 hrs.) } 30'' = 18^{\circ} 50' 55'', \text{ 2 P. M.}$$

$$\begin{array}{r} 18^{\circ} 51' 00''.5 \\ \hline \text{35''.7} \end{array} + \text{ ref. (3 hrs.) } 39'' = 18^{\circ} 51' 39'', \text{ 3 P. M.}$$

$$\begin{array}{r} 18^{\circ} 51' 36''.2 \\ \hline \text{35''.7} \end{array} + \text{ ref. (4 hrs.) } 54'' = 18^{\circ} 52' 30'', \text{ 4 P. M.}$$

$$\begin{array}{r} 18^{\circ} 52' 11''.9 \\ \hline \end{array} + \text{ ref. (5 hrs.) } 1' 24'' = 18^{\circ} 53' 36'', \text{ 5 P. M.}$$

We believe it will be found that the use of the table as illustrated above will not only relieve the surveyor of the perplexity hitherto attending the subject of refractions, but will also enable him to secure more accurate results than were possible by the methods usually given.

The calculation of the declination for the different hours of the day should, of course, be made and noted before the surveyor begins his work, that he may lay off the change from hour to hour, from a table prepared as before described.

TO-FIND THE LATITUDE

Level the instrument very carefully, using the level of the telescope, until the bubble will remain in the middle during a complete revolution of the instrument, the tangent movement of the telescope being used in connection with the leveling-screws, and the axis of the telescope being firmly clamped.

Clamp the vertical arc, so that its zero and the zero of its vernier coincide as near as may be, and bring them into exact line by the tangent screw of the vernier.

Set off upon the proper arc the declination of the sun for noon of the given day, corrected for the meridional refraction. Note the equation of time, and fifteen or twenty minutes before noon direct the telescope to the north and lower the objective end until the sun's image can be brought nearly into position between the equatorial lines, by moving the instrument upon its spindle and the declination arc from side to side.

The declination arc being brought directly in line with the telescope, clamp the axis, and with the tangent screw of the telescope axis bring the image precisely between the lines, following the sun's motion as the image runs below the lower equatorial line, or, in other words, as long as the sun continues to rise in the heavens.

When the sun reaches the meridian the image will remain stationary in altitude for an instant, and will then begin to rise on the plate.

The moment the image ceases to run below is apparent

noon, when the index of the hour arc should indicate XII, and the latitude be determined by the reading of the vertical arc.

The angle through which the polar axis has moved in the operation just described is measured from the zenith instead of the horizon, as in the Solar Compass, so that the angle read on the vertical limb is the complement of the latitude.

The latitude itself is readily found by subtracting this angle from 90° . Thus at Troy the reading of the limb being found as above directed to be $47^\circ 16'$, the latitude will be $90^\circ - 47^\circ 16' = 42^\circ 44'$. The latitude may also be read direct by referring to the inner row of figures on the arc, beginning with 90 in the middle and reading to 10 on either side.

TIME FOR USING THE SOLAR

While the solar can be used with advantage at all seasons of the year, the most favorable time is the summer, when the declination is north and the days are long and more generally fair. It is best not to take the sun at morning and evening when it is within half an hour of the horizon, nor at noon for about the same interval before and after it passes the meridian.

ADVANTAGES OF THE SOLAR IN SURVEYING

While the solar is indispensable in the survey of public lands, it also possesses important advantages over the magnetic needle compass when used in the surveys of farms, and similar work. Not only can lines be run and angles be measured without regard to the diurnal variation or the effect of local attraction, but the bearings, being taken from the true meridian, will remain unchanged for all time.

In favorable weather surveys can be made more rapidly than with the needle instrument, there being no time

consumed in waiting for the needle to settle, or in avoiding the errors due to local attraction.

When the sun is obscured the lines can be run by the needle alone, it being always kept with the sun, or at 0 on its arc, thus indicating the direction of the true meridian. The sun, however, must be regarded as the most reliable guide, and should, if possible, be taken at every station.

With a transit having both vertical and horizontal limbs, direct observations may be taken on the sun to find the **DIRECT** meridian. The best time is about three **OBSERVATION** hours before or after noon. A colored or smoked glass darkener will be necessary over the eyepiece to protect the eye. The observations to be taken are those of the altitude of the sun and its horizontal angle from a fixed point, at the same instant. It is best to take a number of these, say three or five, so as to check; and if the telescope is reversed and another set taken, the mean of the two sets will eliminate many inaccuracies. It is also an advantage to use the lower limb of the sun in the morning and the upper limb in the afternoon, it being easier to judge the tangency of image and cross-wires. Allowance is then made for the semi-diameter of the sun, which varies from $15\frac{3}{4}$ to $16\frac{1}{4}$ minutes. It will be sufficiently close to have the vertical wire bisect the sun, but the altitude must be taken with care. The transit must be accurately leveled and adjusted.

To reduce the observations there are many forms, all deduced from the same formula. The form much favored is

$$\tan^2 \frac{1}{2}A = \frac{\sin [S-(90^\circ-\text{alt.})] \cdot \sin [S-(90^\circ-\text{lat.})]}{\sin S \cdot \sin [S-(90^\circ-\text{dec.})]}$$

REDUCTION In which "A" is the azimuth of the sun or
FORMULA horizontal distance from the meridian, and
 "S" is one-half the sum of $(90^\circ-\text{alt. corrected for refraction}) + (90^\circ-\text{lat.}) + (90^\circ-\text{dec.})$ Note the sign of the

declination. When South would be $(90^\circ - (-\text{dec.}) = 90^\circ + \text{dec.}$

EXAMPLE: Place, Troy, N. Y. Time 3h. 30m. P. M., March 31, 1906.

The horizontal angle from a fixed point to sun's center	241° 46'
Observed altitude of upper limb of sun	30° 31' 10"
Obs. alt. — refraction 1' 40" — semi-diameter 16' = alt. of sun's center	30° 13' 30"
Declination for day and hour	4° 30' 30"
Latitude	42° 44'
$90^\circ - \text{alt.} = 59^\circ 46' 30''$, $90^\circ - \text{dec.} = 85^\circ 29' 30''$,	
$90^\circ - \text{lat.} = 47^\circ 16'$, $2 S = 192^\circ 32'$, $S =$	96° 16'

$$\log. \sin [S - (90^\circ - \text{alt.})] = 9.77430$$

$$\log. \sin [S - (90^\circ - \text{lat.})] = 9.87778$$

$$\hline 9.65208$$

$$\log. \sin S = \dots\dots\dots 9.99740$$

$$\log. \sin [S - (90^\circ - \text{dec.})] = 9.27173$$

$$\hline 9.26913$$

$$\log. \tan^2 \frac{1}{2} A = 0.38295$$

$$\log. \tan \frac{1}{2} A = 0.19148$$

$$\frac{1}{2} A = 57^\circ 14' 25'' \text{ and } A = 114^\circ 28' 50'' \text{ West of North.}$$

If in the morning would be East of North.

Apply this to the horizontal angle from the fixed point to the sun and we have $356^\circ 14' 50''$, which is the reading of the horizontal limb when the telescope is pointed North. Set this reading off on the limb and the telescope will be in the plane of the meridian.

A table of Mean Refractions due to altitude.

Bar. 30 ins., Ther. 50° F., always minus.

App. alt.	Ref.	App. alt.	Ref.	App. alt.	Ref.	App. alt.	Ref.
5°	9' 46"	10°	5' 16"	20°	2' 37"	50°	0' 48"
6°	8' 23"	12°	4' 25"	25°	2' 03"	60°	0' 33"
7°	7' 20"	14°	3' 47"	30°	1' 40"	70°	0' 21"
8°	6' 30"	16°	3' 19"	35°	1' 22"	80°	0' 10"
9°	5' 49"	18°	2' 56"	40°	1' 09"	90°	0' 0'

A Table of Semi-Diameters of the Sun.

Jan. 1, 16' 17"	April 1, 16' 01"	July 1, 15' 45"	Oct. 1, 16' 00"
Feb. 1, 16' 14"	May 1, 15' 53"	Aug. 1, 15' 47"	Nov. 1, 16' 08"
Mar. 1, 16' 09"	June 1, 15' 47"	Sept. 1, 15' 42"	Dec. 1, 16' 14"

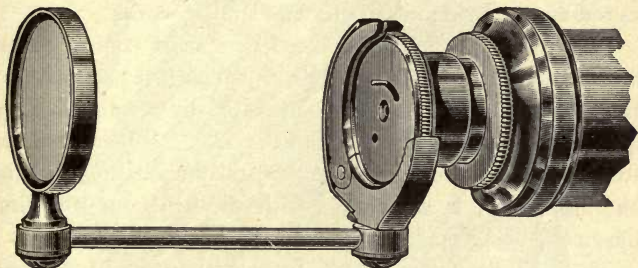
**NO. 192 SOLAR SCREEN**

Price, \$5.00.

If desired, we furnish a solar screen arranged to clamp to the eyepiece end of the telescope, and detachable at will.

SOLAR SCREEN On this screen the image of the sun and cross-wires can be readily observed, a greater movement of the eyepiece, however, being required.

PATENT LATITUDE LEVEL

This attachment, shown in the cut on page 37, is used for recovering the latitude on a solar transit without referring to the vertical arc, and also for setting the telescope at any desired angle in running grades and similar work.

It consists of a level connected by a short conical socket with the end of the telescope axis, to which it is clamped by a milled-head screw, and made adjustable by a tangent screw and spring on the enlarged end of the tube. When the clamp screw is released the level turns vertically upon the axis, and can thus be set at any angle with the telescope, the final adjustment being made by the tangent screw.

. The latitude being set off upon the vertical arc as usual, the level is clamped and brought into the middle, as above described.

The telescope may then be released and used in running lines, until it is desired to recover the latitude again. This is easily and accurately done without referring to the vertical arc. The use of the attachment in running any desired grade is readily understood.

We furnish this attachment without extra charge with any new solar instrument.

Price of Patent Latitude Level added to an old Transit, \$6.00

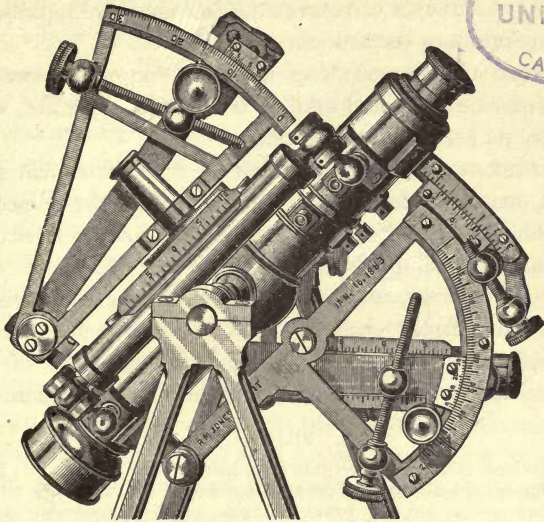
*JONES LATITUDE ARC*

When this attachment is used the vertical arc is omitted, and is replaced by a double latitude arc attached to the under side of the telescope, as shown. The smaller arc, having its center directly under the cross-bar of the telescope, has an arm with vernier reading the arc to single minutes, and carries also a level-tube open at both top and bottom, with a scale over each opening.

In obtaining latitudes with this attachment, the declination being set off as usual, the level-bubble should be brought into the middle of its scale when the sun is on the meridian.

The reading of the smaller arc then gives the latitude of the place, and in all further observations of the latitude reference is made to the level rather than to the graduations, the level being easily brought into the middle of the scale. This

enables the surveyor to recover the latitude more rapidly than with the ordinary vertical arc.

Minute changes, as long lines are run either north or south, may be computed and set off on the larger arc, which reads by its vernier to ten seconds.

But one test of the adjustment of this attachment is required, that both arcs should read zero when the telescope is made horizontal by its long level, and the smaller level of the arc below is also brought to the middle of its scale.

If not correct, they may be adjusted by loosening the screws which fasten each arc, and moving the arcs until the zeros of both are in coincidence with the zeros of their verniers, care being taken to set the screws firmly again.

PRICES

JONES Latitude Arc, with reversible level-bubble	\$73.00
When furnished with a new Transit of our make in place of the ordinary vertical arc, the JONES Latitude Arc, with reversible level-bubble, increases the cost of the instrument.....	55.00
Thus: The Light Mountain Transit, with Solar Attachment and JONES Latitude Arc, costs.....	300.00

TO ADJUST THE SOLAR ATTACHMENT

To adjust the solar attachment, proceed as follows:

**SOLAR LENSES
AND LINES** Detach the declination arm by taking off the clamp and tangent screws, and removing the center by which the arm is pivoted on the arc.

Substitute for the declination arm upon the attachment the adjusting-bar furnished with every solar instrument, the center of the declination arm fitting into the hole at one end of the bar, and the bar being further secured to the attachment by the clamp screw passing through the hole in the declination arc left by the removal of the tangent screw, into the threaded hole at the other end of the adjusting-bar, thus forming a support upon which the declination arm can be adjusted.

Place the declination arm on the adjuster, turn one end to the sun, and bring it into such a position that the image of the sun is made to appear precisely between the equatorial lines on the opposite plate.

Carefully turn the arm over, until it rests upon the adjuster by the opposite faces of the rectangular blocks, and again observe the sun's image. If it remains between the lines as before, the arm is in adjustment. If not, loosen the three small screws and move the silver plate under their heads until one-half the error in the position of the sun's image is removed.

Bring the image again between the lines, and repeat the operation as above on both ends of the arm, until the image will remain between the lines of the plate in both positions of the arm, when it will be in proper adjustment, and the arm may be replaced in its former position on the attachment. This adjustment is very rarely needed in our instruments, the lenses being cemented in their cells and the plates securely fastened.

To adjust the vernier of the declination arc: Set the **DECLINATION** vernier at zero, and raise or lower the tele-
ARC scope until the sun's image appears exactly between the equatorial lines.

Having the telescope axis clamped, carefully revolve the arm until the image appears on the other plate. If precisely between the lines, the adjustment is complete. If not, move the declination arm by its tangent screw until the image will come precisely between the lines on the two opposite plates. Clamp the arm and remove the index error by loosening two screws that fasten the vernier; place the zeros of the vernier and limb in exact coincidence, tighten the screws, and the adjustment is complete.

To adjust the polar axis: Level the instrument carefully by the long level of the telescope, using the tangent movement of the telescope axis in connection with **POLAR AXIS** the leveling-screws, until the bubble will remain in the middle during a complete revolution of the instrument upon its axis.

Place the solar attachment upon the axis and see that it moves easily around it. Bring the declination arm into the same vertical plane with the telescope, place the adjusting-level, No. 196 (see page 95), upon the top of the rectangular blocks, and bring the bubble of the level into the middle by the tangent screw of the declination arc.

Turn the arc half-way around, bringing it again parallel with the telescope, and note the position of the level. If in the middle, the polar axis is vertical in that direction. If not in the middle, correct one-half the error by the capstan-head adjusting-screws under the base of the polar axis, moving each screw of the pair the same amount, but in an opposite direction. Bring the level to the middle again by the tangent

screw of the declination arc, and repeat the operation as before, until the bubble will remain in the middle when the adjusting-level is reversed.

Pursue the same course in adjusting the arc in the second position, or over the telescope axis, and when completed the



No. 196

STRIDING OR ADJUSTING-LEVEL

level will remain in the middle during an entire revolution of the arc, showing that the polar axis is at right angles with the level under the telescope, or truly vertical.

As this is by far the most delicate and important adjustment of the solar attachment, it should be made with the greatest care, the bubble being kept precisely in the middle and frequently inspected in the course of the adjustment.

The adjusting-level is supposed to be itself in adjustment; but if not, it can be easily corrected by the screw shown at one end, when reversed upon a plane surface, exactly as a mason's level is adjusted.

To adjust the hour arc: Whenever the instrument is set in the meridian, as will be hereafter described, the index of the hour arc should read apparent time. If not, loosen the two flat-head screws on the top of the hour circle, and with the hand turn the circle around until the proper reading is indicated, fasten the screws again, and the adjustment will be complete.

HOURLY ARC

ASTRONOMICAL TERMS

IN the following pages we define the terms employed in the use and adjustment of the solar attachment, which may be helpful to one not familiar with solar instruments.

SUN The sun is the fixed center of the solar system, although for convenience it is often spoken of as in motion around the earth.

EARTH The earth makes a complete revolution around the sun in three hundred and sixty-five days, five hours, forty-eight minutes, and forty-six seconds. It also rotates about an imaginary line passing through its center, and termed its axis, once in twenty-three hours, fifty-six minutes, and four seconds, mean time, turning from west to east.

POLES The poles are the extremities of the axis. That in our hemisphere, known as the north pole, if produced indefinitely toward the concave surface of the heavens, would reach a point near the polar star, called the north pole of the heavens.

EQUATOR The equator is an imaginary line passing around the earth, equi-distant from the poles, and in a plane at right angles with the axis. If the plane of the equator were produced to the heavens, it would form what is called the celestial equator.

ORBIT The orbit of the earth is the path in which it moves in its yearly revolution. If the plane of this orbit were produced to the heavens, it would form the ecliptic, or the sun's apparent path in the heavens.

The earth's axis is inclined to its orbit at an angle of about $23^{\circ} 27'$, making an angle of the same degree between

the earth's orbit and its equator, or between the celestial equator and the ecliptic.

EQUINOXES The equinoxes are the two points at which the ecliptic and the celestial equator intersect one another.

The declination of the sun is its angular distance north or south of the celestial equator. When the sun is at the equinoxes, about the 21st of March and the 21st of September of each year, its declination is 0, or it is said to be on the equator. From these points its declination gradually increases, until on the 21st of June and the 21st of December it is $23^{\circ} 27'$ distant from the equator.

It is the declination which causes the sun to appear so much higher in summer than in winter, its altitude in the heavens being about $46^{\circ} 54'$ more on the 21st of June than it is on the 21st of December.

The horizon of a place is the visible boundary of a plane, tangent to the earth at that place, or at right angles to a vertical line. The horizon, or a horizontal surface, is determined by the surface of a liquid at rest, or by the spirit-levels of an instrument.

ZENITH The zenith of a place is the point directly overhead, in a line at right angles with the horizon.

MERIDIAN The meridian circle of a place is a great circle passing through the zenith of that place and the poles of the earth.

The meridian, or true north and south line, is the line determined by the intersection of the plane of the meridian circle with the plane of the horizon.

MERIDIAN ALTITUDE The meridian altitude of the sun is its angular elevation above the horizon, when passing the meridian of the place.

LATITUDE The latitude of a place is its angular distance north or south of the equator, measured on the meridian. At the equator the latitude is 0° , and at the poles 90° .

LONGITUDE The longitude of a place is its angular distance east or west of a given place taken as the starting-point, or first meridian. It is measured on the equator or on any parallel of latitude.

In the Nautical Almanac, which is commonly used with a solar instrument, the longitude of the principal places in the United States is reckoned from Greenwich, England, and expressed both in degrees and hours.

ZENITH DISTANCE The zenith distance of any heavenly body is its angular distance north or south of the zenith of a place, measured when the body is on the meridian.

Suppose a person to be on the equator at the time of an equinox; the sun, when on the meridian, would be in the zenith of the place, and the poles of the earth would lie in the plane of its horizon.

Disregarding, for the present, the declination of the sun, let us suppose that the person travels toward the north pole. As he passes to the north, the sun will descend from the zenith, and the pole will rise from the horizon in the same proportion, until when he arrives at the north pole of the earth the sun will have declined to the horizon, and the pole of the heavens will have reached the zenith.

The altitude of the pole at any place, or the distance of

the sun from the zenith, would, in the case supposed, give the observer the latitude of that place.

If we now take into account the sun's declination, it will increase or diminish its meridian altitude, according as it passes north or south of the equator; but the declination of the sun at any time being known, its zenith distance, and therefore the latitude of the place, can be readily ascertained by an observation made when the sun is on the meridian. It is by this method that we obtain the latitude of any place by the Solar Compass.

TIME A solar day is the interval of time between the departure of the sun from the meridian of a place and its succeeding return to the same position. The length of the solar day, by reason of the inclination of the earth's axis, is constantly changing.

In order to have a uniform measure of time, we have recourse to what is termed a mean solar day, **MEAN SOLAR DAY** the length of which is equal to the mean or average of all the solar days in a year.

The time thus given is called mean solar time, and is the same at any instant for all points on the **MEAN SOLAR TIME** same meridian, differing, however, at points on different meridians.

Since November, 1883, in the United States, the mean solar times of the meridians 60° , 75° , 90° , 105° , and 120° west of Greenwich are adopted as standard **STANDARD TIME** time, and are called respectively Colonial, Eastern, Central, Mountain, and Pacific time. The time of each place differs from that of the next by one hour. Instead of employing the local mean solar time, the time used is the mean solar time at the nearest of the standard meridians.

At Troy, N. Y., the longitude is $73^{\circ} 40'$ west, or four

hours, fifty-four minutes and forty seconds; hence the mean solar time is five minutes and twenty seconds more than the standard time. At Minneapolis the longitude is six hours, twelve minutes and fifty-seven seconds; hence the mean solar time is twelve minutes and fifty-seven seconds less than standard time, since the city is west of the meridian.

EQUATION OF TIME The sun is sometimes faster and sometimes slower than the clock, the difference being called the equation of time.

The moment when the sun is on the meridian of any place is called apparent noon, and this being ascertained, we can, by adding the equation of time for the given day to, or subtracting it from, apparent noon, according as the sun is slow or fast, obtain the time of mean noon, which, converted to standard time, is used to set the watch.

As the earth makes a complete rotation upon its axis once a day, every point on its surface must pass through three hundred and sixty degrees in twenty-four hours, or fifteen degrees in one hour, and so on in the same ratio. As the rotation is from west to east, the sun would come to the meridian of every place fifteen degrees west of Greenwich just one hour later than the time given in the Ephemeris for apparent noon at Greenwich.

To an observer at Troy, N. Y., the longitude of which is, in time, four hours, fifty-four minutes, forty seconds, the sun would come to the meridian nearly five hours later than at Greenwich, and thus, when it was 12 M. at that place it would be only about 7 A. M. in Troy.

REFRACTION By reason of the atmosphere, the rays of light from the sun are bent out of their course, so as to make its altitude appear greater than is actually the case.

The refraction varies according to the altitude of the body observed, being zero when it is in the zenith, about one minute when midway from the zenith to the horizon, and almost thirty-four minutes when in the horizon. The proper allowance to be made for refraction in setting off the declination is fully explained on pages 77 to 84.

If the latitude and declination of the sun were both zero, the position of the sun at noon would be at the zenith and there would be no refraction. At any other latitude, declination or hour, the apparent position of the sun would be lower and refraction must be taken into account. As refraction is due to altitude, it might be suggested to lay it off directly on the vertical limb; but as this would alter the inclination of the polar axis, it must be laid off on the declination arc, and modified to suit the proper inclination of the arc due to latitude, declination, and hour angle.

Again, the angles which the equatorial lines make with the horizon are continually changing, as the declination arm is made to follow the course of the sun during an entire day. Thus in the morning and evening the equatorial lines are more or less inclined to the horizon, while at noon they are parallel with it. It follows that the excess of refraction at morning and evening is in some measure balanced by the fact that the position of the sun's image with reference to the equatorial lines is then less affected by it, on account of the greater inclination of the lines to the horizon.

SURVEYORS' COMPASSES

SOLAR COMPASS

RAILROAD COMPASS

VERNIER COMPASS

PLAIN COMPASS

ATTACHMENTS FOR COMPASSES

COMPOUND BALL-SPINDLE

LEVELING-ADOPTER

LEVELING-HEAD

TELESCOPIC SIGHT

SOLAR COMPASS

THIS instrument was invented by William A. Burt, of Michigan, and patented by him in 1836. It came into general use in the surveys of the United States public lands, the principal lines of which are required to be run with reference to the true meridian.

The invention long since became public property, and for nearly sixty years the Solar Compass has been manufactured by us, with improvements of our own in construction in design which have made it increasingly popular and efficient.

The arrangement of the sockets and plates is similar to that of the Surveyors' Transit, as shown on page 40, except that the sight vanes are attached to the under plate or limb, and this revolves around the upper or vernier plate on which the solar parts are placed.

The limb is graduated to half-degrees, is figured in two rows, 0 to 360 and 0 to 90 each way, and reads by two opposite double verniers to single minutes. The graduations of the limb and all other arcs of the Solar Compass are made upon silver.

This instrument should always be used on a tripod, with screws for ready and accurate leveling, and a tangent screw for directing it to any desired point. - For this purpose a leveling-head with tangent screw, similar to that shown in the cut of the Surveyors' Transit, is furnished with every instrument.

TRIPOD

WEIGHT The Solar Compass with leveling-head, but without tripod, weighs about fifteen pounds.

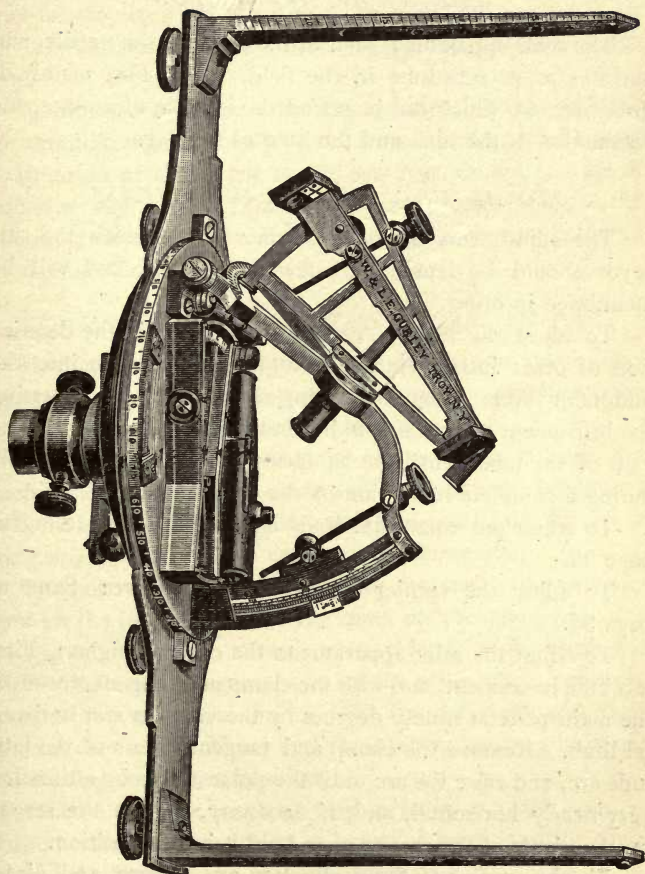

No. 210

Price as shown, including leveling-screws and clamp and tangent to spindle,
and with tripod, \$210.00.

THE SOLAR APPARATUS

The solar apparatus is seen in the place of the needle, and operates as its substitute in the field. It consists mainly of three arcs, by which can be set off the latitude of a place, the declination of the sun, and the hour of the day.

TO ADJUST THE SOLAR COMPASS

The adjustments of this instrument with which the surveyor should be familiar are few and simple, and will be mentioned in order.

To adjust the levels: Proceed as directed in the description of other instruments, by bringing the bubbles into the middle of the tubes by the leveling-screws, and then reversing the instrument upon its spindle and raising or lowering the ends of the tubes, until the bubbles will remain in the middle during a complete revolution of the instrument.

To adjust the equatorial lines and solar lenses: Same as page 93.

To adjust the vernier of the declination arc: Same as page 94.

To adjust the solar apparatus to the compass sights: First level the instrument, and with the clamp and tangent screws set the main plate at ninety degrees by the verniers and horizontal limb. Remove the clamp and tangent screws of the latitude arc, and raise the arc until the polar axis is by estimation very nearly horizontal, and, if necessary, tighten the screws on the pivots of the arc, so as to hold it in this position.

Fix the vernier of the declination arc at zero, and direct the outside edges of the lens blocks to some distant and well-marked object, and observe the same through the compass sights. If the same object is seen by both observations, and

the verniers read to ninety degrees on the limb, the adjustment is complete. If not, the correction must be made by moving the compass sights or changing the position of the verniers.

As the solar parts are attached permanently to the sockets, and this adjustment is made by the manufacturer, it will need no attention at the hands of the surveyor, except in case of serious accident. The other adjustments are also made in the process of finishing the instrument, and are not liable to derangement in careful use.

TO RUN LINES WITH THE SOLAR COMPASS

Having set off the latitude and declination upon their respective arcs and the instrument being in adjustment, the surveyor is ready to run lines by the sun.

To do this, the instrument is set over the station and carefully leveled, the plates clamped at zero on the horizontal limb, and the sights directed north and south, the direction being approximated when unknown by the needle.

The solar lens is then turned to the sun, and, with one hand on the instrument and the other on the revolving arm,

TRUE both are moved from side to side, until the
MERIDIAN sun's image appears on the silver plate, precisely between the equatorial lines. The line of sight will then indicate the true meridian, and the observation may be made and the flagman put in position.

When a due east and west line is to be run, the verniers of the horizontal limb are set at ninety degrees, and the sun's image kept between the lines, as before.

The Solar Compass being so constructed that when the sun's image is in position the limb must be clamped at zero in order to run a true meridian line, it will be evident that

the bearing of any line from the meridian may be read by the verniers of the limb precisely as in the transit.

In running lines, the magnetic needle may be kept with the sun, that is, the point of the needle is made to indicate zero on the arc of the compass box, by turning the tangent screw connected with its arm on the opposite side of the plate. Lines can thus be run by the needle alone in case of the temporary disappearance of the sun, but the surveyor must be sure that there is no local attraction. The magnetic declination, which should be noted at every station, is read off on the arc by the vernier on the arm of the needle box.

In using the Solar Compass, if the revolving arm be turned a little to one side of its proper position, a false or reflected image of the sun will appear on the silver plate in nearly the same place as that occupied by the true one. It is caused by the reflection of the true image from the surface of the arm, and is a fruitful source of error to the inexperienced surveyor. It can, however, be readily distinguished from the real image by being less bright, and not so clearly defined.

When the bearings of lines, such as the course of a stream or the boundaries of a forest, are not desired with the certainty given by the verniers and the horizontal limb, a rough approximation of the angles which they make with the true meridian is obtained by the graduations on the outside of the circular plate. In this operation, a pencil or thin straight-edge of any kind is held perpendicularly against the circular edge of the plate, and moved until it is in range with the eye, the brass center-pin, and the object observed. The bearing of the line is then read off at the point where the pencil is placed.

SUPERIORITY OF OUR SOLAR COMPASSES

The Solar Compass as first made, though planned with great ingenuity in its general arrangement, was extremely rude in its mechanical details and adjustments.

The points in which we claim the superiority of our Solar Compass over any other manufactured are partially shown in the cut on page 107, and may be stated in detail as follows:

1. A motion of the horizontal plates entirely free from friction, combined with perfect rigidity.
2. A tangent movement to the limb, as shown under the plate.
3. A tangent movement with clamp to the declination arc.
4. A tangent movement with clamp to the latitude arc.
5. A tangent movement for the whole instrument about its socket.
6. Increased facility of adjustment, and therefore an important saving of time.

RAILROAD COMPASS

THE Railroad Compass is an instrument intended for land surveying in localities where it is necessary to measure horizontal angles independently of the needle, as in cases of local attraction.

The accuracy and minuteness of the horizontal angles indicated by this instrument, together with its perfect adaptation to all the purposes for which the Vernier Compass can be used, have brought it into use in many localities where land is so valuable as to require more careful surveys than are practicable with a needle instrument.

This instrument is a compass of the highest grade, with a graduated limb and verniers like those of the transit. As shown on page 114, it has the main **PLATES AND LIMB** plate, levels, sights, and needle of the ordinary compass, and, in addition, underneath the main plate, a graduated circle or limb by which horizontal angles to single minutes can be taken independently of the needle. The limb is figured in two rows, 0 to 360 and 0 to 90 each way.

The arrangement of the sockets is like that of the Surveyors' Transit with two verniers to limb, and the **SOCKETS** plates can be separated and replaced in the same manner.

The verniers are attached to the under surface of the main **VERNIERS** plate at an angle of thirty degrees with the line of sights, the vernier openings being covered with glass to protect the graduations from dust and moisture.

The connection between the two plates is made by a

clamp and tangent movement with opposing spring, shown at *t* underneath the plates.

The needle-lifting screw is shown at *n*, on the left of the plate. On the right of the compass circle is seen the head of a pinion working into a rack fixed to the edge of the compass circle, enabling the surveyor to move it about its center in setting off the magnetic declination, as described on page 115. The declination is read to single minutes by a vernier and graduated arc, partially shown in the cut.

A clamp screw is shown at *c*, by which the circle may be securely fixed when moved to the proper position.

The telescopic sight, hereafter described, is often used with the Railroad Compass with excellent results.

We make two sizes of this instrument, with needles respectively five and five and one-half inches in length. The smaller size, including the brass head of the staff, weighs thirteen pounds, and the larger size weighs about fourteen pounds.

TO USE THE RAILROAD COMPASS

The Railroad Compass can be used upon the common ball-spindle, or better upon the tangent ball, placed either in a staff socket, a compass tripod, or the leveling-adopter and tripod, as shown on page 131. The instrument may also be used upon the leveling-head with clamp and tangent movement and tripod, and this is preferable to any other support. (See page 132.)

To take horizontal angles: Having leveled the plate and set the limb at zero, fix the sights upon one of the objects selected, and, clamping the whole instrument to the spindle, unclamp the vernier plate and turn it with the hand until the sights are brought nearly upon the

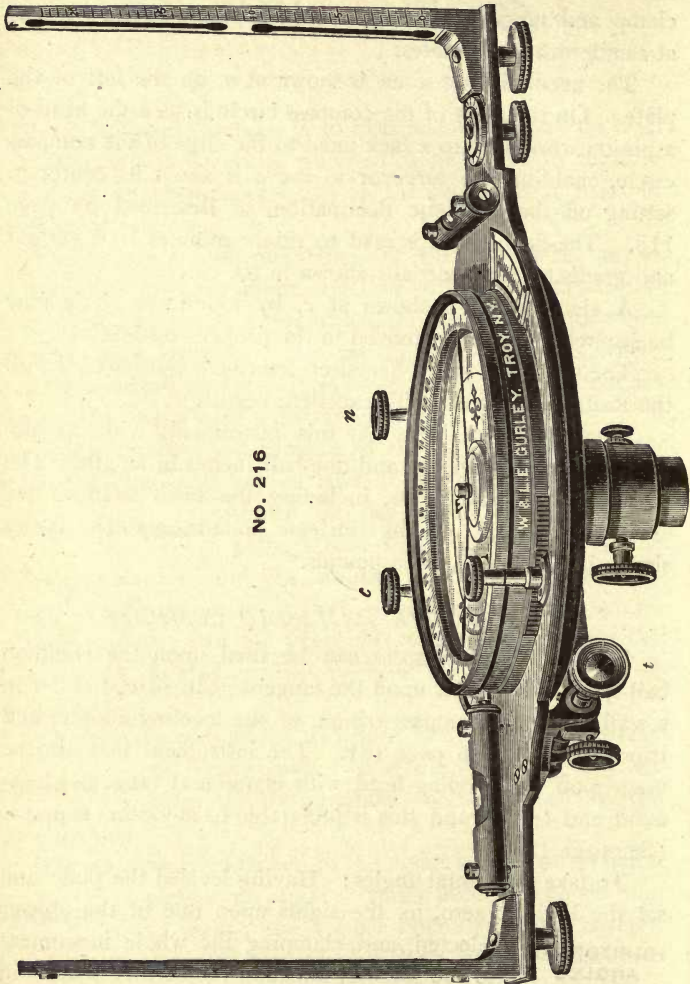

NO. 216

Railroad Compass, with two verniers to limb, $5\frac{1}{2}$ -inch needle, and staff mountings.
Price, \$75.00.

second object ; then clamp to the limb, and with the tangent screw fix them precisely upon it. The number of degrees and minutes read off by the vernier will give the angle between the two objects, taken from the center of the instrument.

It will be understood that horizontal angles can be taken in any position of the verniers with reference to the zero point of the limb. We have given that above as being the usual method and the one least liable to error.

Where extreme accuracy is required, it is advisable, in this and other instruments which have two verniers, to obtain the readings of the limb from both, add the two together and halve their sum. The result will be the mean of the two readings, and the true angle between the points observed.

In taking horizontal angles, the magnetic bearings of the two objects are often noted, and thus two separate readings of the same angle, one by the limb and the other by the needle, are obtained, to be used as checks upon each other to prevent mistakes.

To set off the magnetic declination : Having leveled the instrument, set the limb at zero and place the sights upon the old line, note the reading of the needle, and make it agree with that given in the field notes of the former survey by turning the compass circle about its center by the pinion head. Clamp the compass circle, and the number of degrees or minutes passed over by the vernier of the circle will be the change of magnetic declination in the interval between the two surveys.

To survey with this instrument, the operator should turn the south end of the compass toward his person, and having brought the zeros of the limb and vernier plate in line, clamp the plates, and proceed as directed in the account of the Vernier Compass.

It will be remembered that lines can be run and angles measured by the graduated limb and verniers, independently of the needle; and in places where local attraction is manifested this is very desirable.

RAILROAD COMPASS, ONE VERNIER TO LIMB

This instrument is essentially like that just described, but of somewhat simpler construction in its sockets. It is in every way accurate and reliable, although offered at a price materially lower than that of the compass with two verniers.

We make but one size of this instrument, which has a five and one-half-inch needle, and weighs about thirteen pounds.

VERNIER COMPASS

THIS instrument, shown on page 118, has its compass circle, to which is attached a vernier, movable about its center a short distance in either direction, enabling the surveyor to set the zeros of the circle at any required angle with the line of sights. The number of degrees contained in this angle, or the declination of the needle, is read off by the vernier.

The compass circle is graduated to half-degrees on its upper surface, the whole-degree marks being also cut down on the inside circumference, and is figured from 0 to 90 on each side of the line of zeros. The circle and face of the compass are silvered.

COMPASS CIRCLE The movement of the circle is effected either by a tangent screw, as shown in the cut, or by a concealed rack and pinion, the head of which projects from the under side of the main compass plate. When the declination is set off as described, the circle is fastened in its position by a clamp screw.

VERNIER The vernier is graduated on its edge into thirty equal parts, and figured in two series on each side of the middle line.

In the same plane with the vernier is an arc or limb, fixed to the main plate of the compass, and graduated to half-degrees. Each space on the vernier is one minute shorter than a single space on the limb. The surfaces of both vernier and limb are silvered.

The spirit-levels are placed at right angles with each other so as to level the plate in all directions, and are **LEVELS** balanced upon a pivot under the middle of the tube, so as to be adjustable by a screw-driver.

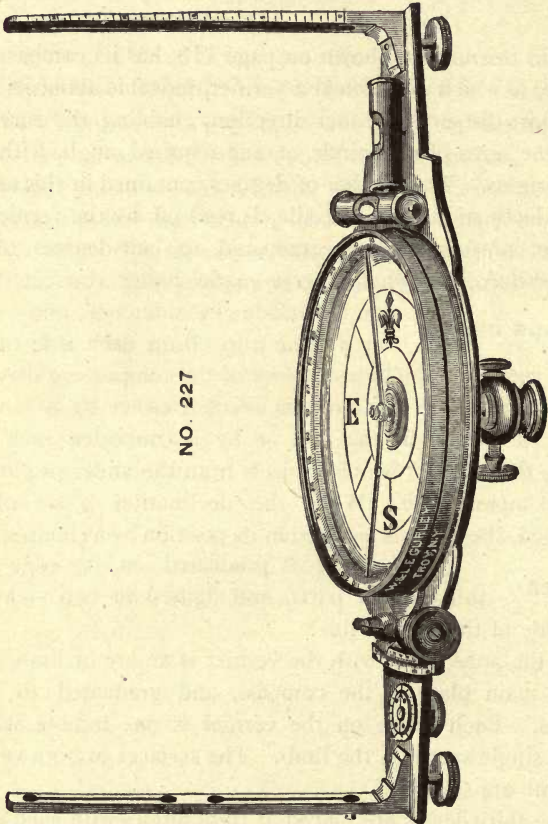

NO. 227

Vernier Compass, 6-inch needle, with staff mountings.
Price, \$40.00.

Underneath the main plate is a needle-lifting screw which, by moving a concealed spring, **NEEDLE-LIFTER** raises the needle from the pivot, and thus prevents the blunting of the point in transportation.

When the compass is not in use, it is the practice of many surveyors to let down the needle upon the point of the center-pin, and allow it to assume its position in the magnetic meridian, so as to retain its polarity. We would advise that after the needle has settled it should be raised against the glass, in order not to dull the point of the center-pin.

A small dial plate, having an index turned by a milled head underneath, is used with this and other **OUTKEEPER** compasses to keep tally in chaining. The dial is figured from 0 to 16, the index being moved one notch for every chain run.

A brass cover is fitted over the glass of **BRASS COVER** the compass, and serves to protect it from accident, as well as to prevent electric disturbance.

The sights, or sight vanes, have fine slits cut through nearly their whole length, terminated at intervals by circular **SIGHTS** apertures, through which the object sighted upon is more readily found. Sometimes a horse hair or wire is substituted for half the slit, and placed alternately with it on opposite sights.

The telescopic sight is often used with the Vernier Compass, and its adjustments and use are described on pages 133 to 139.

The right and left edges of the north sight of our compasses are graduated to half-degrees for angles of elevation and depression respectively, which are **TANGENT SCALE** read from corresponding peep-holes on the south sight.

The cut shows the eyepiece and graduations for angles of elevation. Those for angles of depression, not shown in this cut, are seen in the cut of the Plain Compass.

The compass is fitted to a spindle made slightly conical, and having on its lower end a ball turned perfectly spherical, and confined in a socket by a pressure so light that the ball can be moved in any direction in leveling the compass. The ball is placed either in the brass head of the staff, or better in the compass tripod seen in the cut of the Vernier Transit on page 53.

A leveling-adopter, shown on page 131, is also often used for more convenient leveling of the compass.

The staff mountings consist of the brass head already mentioned, and a pointed steel shoe. The staff, to which the mountings should be securely fastened, may be procured from any wheelwright, or provided by the surveyor himself.

In the side of the hollow socket of the compass is a screw by which the instrument may be clamped to the spindle in any position.

Besides the clamp screw there is fitted to the sockets of our compasses a spring catch, which, as soon as the instrument is set upon its spindle, slips into a groove, and thus removes all danger of the instrument falling from the spindle while being carried.

We make three sizes of the Vernier Compass, having needles respectively four, five, and six inches long, the main plates being respectively twelve and one-half, fifteen, and fifteen and one-half inches long. The sights of the smallest are about an inch shorter than the others.

In the four- and five-inch Vernier Compasses, the variation arc is within the compass circle, like that of the Railroad

Compass, and the magnetic declination is set off to minutes by a pinion head underneath the plate, this arc being clamped by a screw placed opposite the pinion.

The average weights of the different sizes, including the
WEIGHTS brass head of the staff, are respectively six and one-quarter, eight and three-quarters, and ten and one-half pounds.

USE OF THE VERNIER

The superiority of the Vernier over the Plain Compass consists in its adaptation to retracing the lines of an old survey, and to the surveys of the United States public lands, in which the lines are based on a true meridian.

In reading the vernier, if it is moved to the right, count the minutes from its zero point to the right, and vice versa.

TO READ THE VERNIER Proceed thus until a graduation on the vernier is found exactly in line with another on the limb, and the first row of figures on the vernier will give the number of minutes passed over. When the vernier is moved more than fifteen minutes to either side, the number of additional minutes, up to thirty or one-half degree of the limb, is given by the second row of figures on the opposite side of the vernier. To read beyond thirty, add the minutes given by the vernier to that number, and the sum will be the correct reading.

In all cases where the zero point of the vernier passes a whole degree of the limb, this must be added to the minutes, in order to ascertain the distance over which the vernier has been moved.

It is well known that the magnetic needle deviates more
MAGNETIC DECLINATION or less to the east or west of a true meridian, or north and south line. This deviation, which is called the magnetic declination, is not constant,

but increases or decreases to a very sensible degree in a series of years.

Thus, at Troy, N. Y., a line bearing in 1871, N. 31° E., would in 1906, with the same needle, have a bearing of about N. $33^{\circ} 20'$ E., the needle having in that interval traveled nearly $2^{\circ} 20'$ to the west.

For this reason, in running over lines from field notes of some years' standing, the surveyor is obliged to make an allowance, both perplexing and uncertain, in the bearing of every line. It was to obviate this difficulty that the Vernier Compass was devised.

It will be seen that the surveyor having the Vernier Com-
TO SET OFF THE pass can, by moving the vernier to either
DECLINATION side, and with it, of course, the compass
 circle attached, set the compass to any declination.

He therefore places his instrument on some well-defined line of the old survey, and turns the tangent screw until the needle of his compass indicates the same bearing as that given in the field notes of the original survey. Then, clamping the vernier, he can run all the other lines from the old field notes without further alteration.

The reading of the vernier on the limb in such a case would show the change of declination of the two different periods.

The magnetic declination at any place being known, a true meridian, or north and south line, may be run by moving the vernier to either side, as the declination is east or west, until the arc passed over on the limb is equal to the angle of declination, and then turning the compass until the needle is made to cut the zeros on the graduated circle. The line of sights will then give the direction of the true meridian of the place.

Such a change in the position of the vernier is necessary in surveying the United States public lands, which surveys are always run from the true meridian.

The line of no declination, or the line upon which the needle will indicate a true north and south direction, is **LINE OF NO DECLINATION** situated in the United States nearly in an imaginary line drawn from Sault Ste. Marie, Michigan, to Charleston, South Carolina. A magnetic needle placed east of this line has a declination to the west, and when placed west of the line the declination is to the east; and in both cases it increases as the needle is carried farther from the line of no declination.

Thus, in Minnesota, the declination is from eight to eleven degrees to the east, while in Maine it is from fifteen to nineteen degrees to the west. At Troy, in the year 1906, the declination is about $11^{\circ} 21'$ to the west, and is increasing in the same direction about three minutes annually.

The magnetic declination does not remain constant through an entire day, but reaches its farthest point east about **DIURNAL VARIATION** 8 o'clock A. M., and its farthest point west about 2 o'clock P. M. The cause of this daily variation of the needle is not understood, as observations show that it is greater in summer than in winter.

Conditions of temperature, magnetic storms and other causes at times affect the needle. Our own experiments show that different needles observed at the same time and under the same conditions differ in their direction, but show nearly the same daily change.

A less important use of the vernier is to give a reading of **TO READ TO MINUTES** the needle to single minutes, which is obtained as follows: First be sure, as in all observations, that the zero of the vernier exactly corre-

sponds with that of the limb. Then, noting the number of whole degrees given by the needle, move back the compass circle with the tangent screw until the nearest whole-degree mark is made to coincide with the point of the needle, read the vernier as before described, and this reading added to the whole degrees will give the bearing to minutes.

TO ADJUST THE COMPASS

To adjust the levels: Bring the level-bubbles into the middle by the pressure of the hand on different parts of the plate, and turn the compass half-way around.

LEVELS Should the bubbles run to the end of the tubes, it would indicate that those ends were the highest. Lower them by loosening the screws under the lowest ends and tightening those under the highest ends until, by estimation, the error is half removed. Level the plate again, and repeat the first operation until the bubbles will remain in the middle during an entire revolution of the compass.

The sights may next be tested by observing through the slits a hair or thread, made exactly vertical by a plummet.

SIGHT VANES Should the hair appear on the side of the slit, the sight must be adjusted by filing its under surface on the side which seems the highest.

NEEDLE To adjust the needle: Having the eye nearly in the same plane with the graduated rim of the compass circle, with a splinter of wood or an iron wire bring one end of the needle in line with any prominent graduation of the circle, as the zero or the ninety-degree mark, and notice if the other end corresponds with the degree on the opposite side. If it does not, bend the center-pin, by using the small brass wrench furnished with our compasses, about one-eighth of an inch below the point of the pin, until the

ends of the needle are brought into line with the opposite degrees.

Then, holding the needle in the same position, turn the compass half-way around, and note whether it now cuts opposite degrees. If not, correct half the error by bending the needle, and the remainder by bending the center-pin. The operation should be repeated until perfect reversion is secured in the first position.

This being obtained, it may be tried on another quarter of the circle. If any error is there manifested, the correction must be made in the center-pin only, the needle having been already straightened by the previous operation.

When again made to cut, it should be tried on the other quarters of the circle, and corrections made in the same manner until the error is entirely removed, and the needle will reverse in every point of the graduated surface.

TO USE THE COMPASS

In using the compass, the surveyor should keep the south end toward his person, and read the bearings from the north end of the needle. He will observe that the E and W letters on the face of the compass are reversed from their natural position, in order that the direction of the line of sight may be correctly read.

The compass circle being graduated to half-degrees, a little practice will enable the surveyor to read the bearings to quarter-degrees or even less, estimating with his eye the space bisected by the point of the needle; and as this is as close as the traverse table is usually calculated, it is the general practice.

Having leveled the compass, bring the south end toward the person, place the eye at the little button, or eyepiece, on

the right side of the south sight, and with the hand hold a card on the front surface of the north sight, so that its top edge will be at right angles with the graduated edge and coincide with the zero mark. Then, sighting over the top of the card, note upon a flagstaff, held near the compass, the height cut by the line of sight, move the staff up the elevation and carry the card along the sight until the line of sight again cuts the same height on the staff. Read off the degrees and half-degrees passed over by the card, and this will be the angle required.

ANGLES OF DEPRESSION Proceed in the same manner, using the eyepiece and graduations on the opposite side of the sight, and reading from the top of the sight.

NEW AND OLD SURVEYS When the compass is to be used in making new surveys, the vernier should be set at zero and clamped by the nut underneath the plate.

In surveying old lines, the change of the magnetic declination should be ascertained by setting the compass on some well-defined line of the tract, and making the bearing agree with that of the old survey, by moving the circle as already described. The circle can then be clamped, and the old lines retraced from the bearings given by the original surveyor.

When the magnetic declination is known, it can be set off by the vernier, and the compass used to run a true meridian by the needle.

Caution should be exercised in handling the compass, that the glass face does not become charged with electricity excited by the friction of cloth, silk, or the hand, so as to attract the needle to its under surface.

ELECTRICITY Should the glass become so charged, however, the electricity may be removed by breathing upon it, or by touching different

parts of its surface with the moistened finger. Ignorance of this apparently trifling matter has caused the inexperienced surveyor much annoyance.

REPAIRS TO THE COMPASS

To enable the surveyor to make such repairs as are possible without recourse to an instrument maker, we add a few simple directions.

The magnetic needle is the most vexatious and troublesome part of a surveyor's instrument, and its imperfect working is almost invariably due to a roughened
NEEDLE or scratched jewel or to a dulled center-pin, or to both, and rarely to loss of magnetism.

A wire is coiled on the south end of the needle, and may be moved back or forth to counterbalance the varying magnetic attraction at the north end, as a needle which is perfectly balanced in one locality is frequently out of balance in a different latitude.

It may sometimes happen that the needle has lost its polarity and must be remagnetized. To do this, proceed as follows: Unscrew the bezel ring that holds the glass face, and remove the needle. Pass each end of the needle from middle to extremity with a gentle pressure over the magnetic pole of a permanent magnet, describing before each pass a circle of about six inches radius, to which the surface of the pole is tangent, drawing the needle toward the body, and taking care that the north and the south ends are applied to the opposite poles of the magnet.

Should the needle be returned in a path near the magnetic pole, the current induced by the contact of the needle with the magnet, in the pass just described, would be reversed, and the magnetic virtue almost entirely neutralized at each

operation. When the needle has been passed in this manner about twenty-five times in succession, it will be fully charged.

The center-pin should occasionally be examined, and, if much dulled, should be taken out with the brass wrench or with a pair of pliers, and sharpened on a hard oilstone, the operator placing it in the end of a small stem of wood, or in a pin-vise, and delicately twirling it with the fingers as he moves it back and forth at an angle of about thirty degrees with the surface of the stone.

When the point is made so fine and sharp as to be invisible to the eye, it should be smoothed by rubbing it on the surface of a soft and clean piece of leather.

To put in a new glass: Unscrew the bezel ring, and with the point of a knife blade spring out the brass ring above the glass. Remove the old glass and scrape out the putty. If the new glass does not fit, smooth off its edges by holding it obliquely against the surface of a revolving grindstone until it will enter the ring easily. Put in new putty and spring in the brass ring.

To replace a level-vial: Take out the screws which hold the level-tube to the plate, pull off the brass ends of the tube, and with a knife blade scrape out the plaster from the tube. Then with a stick a little smaller than the diameter of the tube, with its end hollowed out so that it will bear only on the broad surface of the level-vial, push out the old vial and replace it with a new one, taking care that the crowning side, which has a file mark on the end of the vial, is placed on the upper side.

When the vial does not fit the tube, it must be wedged by putting slips of paper under it, until it moves in snugly.

After the vial is in its place, put around its end plaster

of paris mixed with water to the consistency of putty, taking care not to cover the tip of the glass, and slip on the brass ends. Melted beeswax dropped upon the ends of the vial is quite as effective as the plaster of paris, and often more easily obtained.

An extra glass and level-vials are furnished, free of charge, with every new compass.

See also Repairs to Compasses, page 261.

PLAIN COMPASS

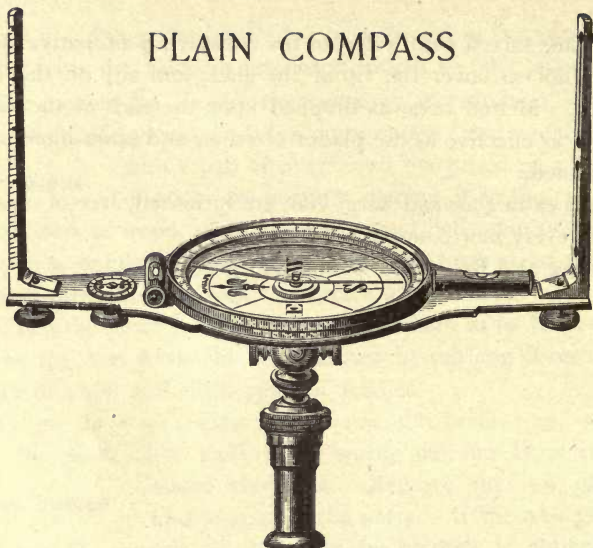

No. 232

Price, with 6-inch needle and staff mountings, \$35.00.

THE Plain Compass shown in the cut has a six-inch needle, and is furnished with levels, sight vanes, socket, etc.

The compass box is in the same piece with the main plate, and the instrument is used chiefly in the surveys of new lines, or in the preparation of maps, where the magnetic declination is not required.

We make three sizes of this instrument, having needles respectively four, five, and six inches long, and differing also in the length of the main plate, which, in the **SIZES AND WEIGHTS** four-inch compass is twelve and one-half inches long, and in the larger sizes fifteen and fifteen and one-half inches. The average weights of the different sizes, with the brass mountings of the staff, are respectively six, seven and three-quarters, and nine and one-half pounds.

The adjustments and use of the Plain Compass are substantially the same as those of the Vernier Compass just described.

COMPOUND BALL-SPINDLE We manufacture a compound ball-spindle, which has a tangent movement, and which gives all the perfection of more costly arrangements at a very moderate expense.

As shown in the cut, No. 240, it has an interior spindle, around which an outside hollow cylinder is moved by turning the double-headed tangent, which has in the middle a screw, working into teeth cut spirally around the cylinder. The compass or other instrument revolves on the outside socket, exactly as if placed on a common ball-spindle; but when a slower movement is desired, it can be clamped and turned gradually around the interior spindle by the tangent screw, until the slit of the sight or the intersection of the wires is brought accurately upon the point observed.



No. 240

No. 241

When the compound ball-spindle is ordered with a compass, we omit the plain ball-spindle and make a reduction of \$2.00 from the price of the instrument.

Price of Compound Ball-spindle.....\$9.00

LEVELING-ADOPTER For more convenient leveling of the compass, as well as other instruments, we make the leveling-adopter shown in No. 241, which is screwed to the top of the tripod like the leveling-head. It can be used

either with a simple ball-spindle, or with the compound ball with tangent screw, as shown in the cut.

The instrument is made approximately level upon the ball, and finally made truly horizontal by the leveling-screws.

Price of Leveling-Adopter, without tripod or ball-spindle\$ 7.00
 With tripod and Compound Tangent Ball, as shown.. 21.00

We also make for use with surveyors' compasses and

vernier tran- **LEVELING-HEAD**
 sit compasses

a leveling-head, consisting of upper and lower plates, four leveling-screws, and clamp and tangent movement. See Nos. 176 and 242 of the Price List.

This leveling-head furnishes a stable support for the instrument, and affords the same conveniences for leveling and accurate adjustment in azimuth as the leveling-heads on the more expensive instruments.

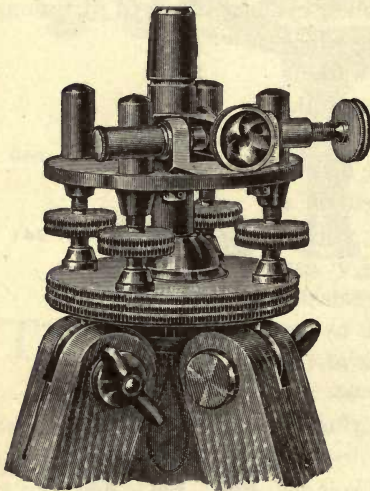

**Nos. 176 AND 242
 LEVELING-HEAD**

Price of Leveling-head complete with tripod, and fitted to the socket of Compass or Vernier Transit..\$18.00
 Without the tripod..... 13.00

TELESCOPIC SIGHT

WE have for years furnished a telescope which can be attached to the sight vanes of compasses, and easily removed, and many hundreds of these attachments are now in use in all parts of the country

This telescope is fitted with cross-wires, and is attached to a movable band which, as shown in the cut, can be slipped over the sight of a compass, clamped at any point desired, and adjusted with a screw-driver and a steel adjusting-pin.

To put this attachment in place, slip the band over the south sight of the compass, having the telescope at the right hand and the clamp screw on the outer surface of the sight, placing the band as low as will allow the telescope to revolve without striking the compass. This place should be marked by a line across the sight, or by a screw or pin on the inner surface of the sight, that the band may be set at the same point in subsequent use.

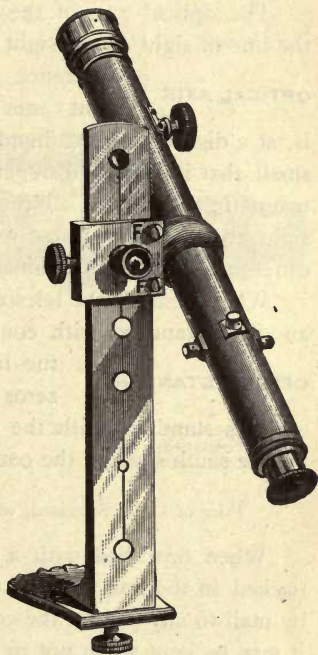

Price of Telescope No. 261, as shown, with movable band for attaching, \$18 00.

To fasten the band to the sight, bring up the clamp screw

with a pressure just sufficient to hold the band to its place, tighten the screw on the left until the band is against the right edge of the sight, and finally tighten the clamp screw.

To focus the telescope, turn the end of the eyepiece until by the spiral motion of the tube the cross-wires are brought into distinct view. The objective is then moved in either direction by the pinion on the side of the telescope, until the object is clearly seen.

The optical axis of the telescopic sight is at one side of the line of sight of the sight vanes, but parallel with it. The

OPTICAL AXIS difference between a sight taken with the sight vanes and one taken with the telescope is, at a distance of two hundred feet, about two minutes; so small that it may be disregarded in any survey made with the magnetic needle. If all the lines are run with the telescopic sight, the angles measured will be accurate, as even this slight difference is entirely eliminated.

When desired, the telescopic sight may be mounted upon an offset standard with counterpoise, and so arranged that

OFFSET STANDARD the line of sight is in line with the zeros of the compass circle. When in use this standard, with the telescope attached, is substituted for the south sight of the compass.

Price of Offset Standard, with Counterpoise.....\$7.50

When furnished with a new instrument the telescope is packed in the box with the compass, but it can be safely sent by mail to any part of the country, packed in a case in which it may be kept when not in use.

SIZES AND POWER We make two styles of the telescopic sight, Nos. 261 and 262 of the Price List. The telescopes are about nine inches long

and have a power of eighteen to twenty diameters. No. 262 is furnished with stadia wires, in addition to the plain cross-wires used in the other telescope.

The attachments of vertical circle three inches in diameter and reading to five minutes, level on telescope with graduated vial, and clamp and tangent to axis, may be used with either of these telescopic sights. Whenever the level is used, it is necessary that the clamp and tangent to axis be added.

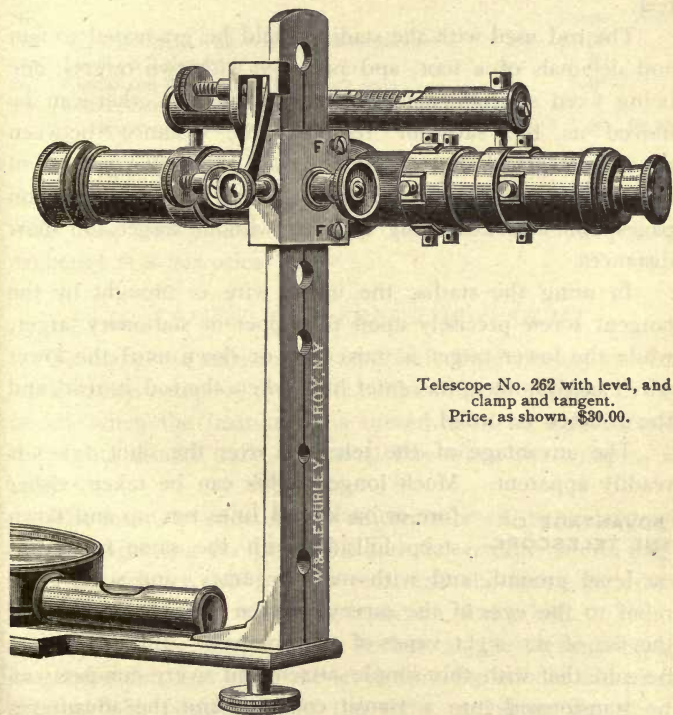

Telescope No. 262 with level, and
clamp and tangent.
Price, as shown, \$30.00.

In the cut on page 135, the telescope No. 262 is shown fitted with a level, and clamp and tangent. For simple sighting the level and circle can, of course, be dispensed with, but in the use of the stadia the tangent movement is very desirable.

When measurements are to be recorded in chains and links, the stadia wires should be made to cover one foot at a distance of sixty-six feet; if recorded in feet, the wires should cover one foot at a distance of one hundred feet.

The rod used with the stadia should be graduated to feet and decimals of a foot, and provided with two targets, one being fixed at some definite point, while the other can be moved as the surveyor requires, the distance between the two targets being accurately read off by the vernier of the movable one. A self-reading rod, as described on pages 199 and 201, may be used without target for short distances.

In using the stadia, the upper wire is brought by the tangent screw precisely upon the upper or stationary target, while the lower target is moved up or down until the lower wire exactly bisects its center line, when the rod is read and the distance recorded.

The advantage of the telescope over the sight vanes is readily apparent. Much longer sights can be taken, either
ADVANTAGE OF THE TELESCOPE fore or back, and lines run up and down steep hillsides with the same facility as on level ground, and with more accuracy, and with great relief to the eyes of the surveyor, often severely strained by the use of the sight vanes of the compass. Indeed, it may be said that with this simple attachment every compass can be transformed into a transit compass, and the advantages

of the telescope brought within the reach of every surveyor, at small cost.

PRICES OF TELESCOPIC SIGHTS AND ATTACHMENTS

No.		PRICE	POST.
261	Nine-inch Achromatic Telescope, power about 20 diameters.....	\$18.00	\$0.45
262	Same Telescope as No. 261, but furnished with stadia wires for measuring distances.....	20.00	.50

We add to new telescopic sights the following extras, at prices annexed.

No.		PRICE	POST.
265	Vertical Circle with vernier to five minutes.....	\$5.00	
266	Level on Telescope.....	5.00	
267	Clamp and Tangent to Telescope axis.....	5.00	
268	Offset Standard with Counterpoise, to bring the Telescope over the line of zeros.....	7.50	\$0.50

We cannot attach the extras, Nos. 265, 266, and 267, to old telescopes, but we will furnish new telescopic sights fitted with these attachments and will take the old telescopes in exchange at a fair price.

TO ADJUST THE TELESCOPIC SIGHT

To make the adjustments, and indeed to do any correct work with a compass, the level-bubbles should remain in the middle when the instrument is turned upon its spindle, and the sights should trace a vertical line when the compass is level.

The means of effecting the adjustments will be understood by the engraving on page 133 and the outline cut on page 138, the former showing the rear, and the latter the front view of the band to which the telescope is attached.

To make the telescope axis horizontal, the compass being in good order, first bring the levels into the middle and place the band in position upon the sight, as before described.

Focus the telescope, and set the vertical cross-wire on the **TELESCOPE AXIS** edge of a building distant from fifty to sixty feet, at a point near the ground. Clamp the compass to the spindle, and raise the telescope to the top of the building. If the wire strikes to the right of the edge, it shows that the right end of the telescope axis is the lowest.

To raise it, loosen the screws, B B, C C, which hold the piece containing the axis of the telescope, and by the screws, D D, the lower of which should be unscrewed and the upper one tightened, raise the telescope until the wire will follow the vertical line.

If the cross-wire strikes to the left when the telescope is raised, proceed exactly the reverse in making the correction, until the wire will follow the edge from one end to the other. If the vertical cross-wire is not parallel with the edge, loosen the capstan-head screws, and turn the ring by the screw heads until the correction is made; then tighten the screws.

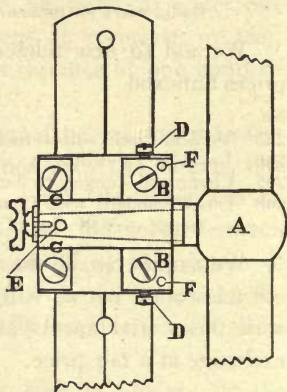

To bring the line of collimation into a position at right angles with the axis of the telescope, so that **LINE OF COLLIMATION** the cross-wires will indicate two points in opposite directions in the same straight line, proceed as directed on pages 22 to 24.

ADJUSTMENT OF TELESCOPE TO THE SIGHTS

Find or place two objects, one on each side of the compass and from three hundred to four hundred feet distant from it, which the sight vanes will intersect. Clamp to the spindle

and sight through the telescope at either of the objects. If the vertical wire strikes to the right, loosen the screws BB, and screw up those in front, marked FF, the ends only of which are shown in the figure, until the vertical wire bisects the object, looking again through the vanes to see that the same object is seen through both telescope and sights. If the cross-wire should strike to the left of the object, proceed in a manner exactly the reverse until the error is corrected.

This adjustment is always made by us before the attachment leaves our hands, and need not be disturbed except in case of accident or careless interference with the cross-wire screws; but it can be easily made by any surveyor in a few moments and with very little practice.

When the adjustments are complete, the attachment can be put in place on the sight, and removed and replaced again, without danger of derangement.

and right through the recesses in front of the object. If
 the vertical line is a line of light, the vertical line
 will give a line of light through the recesses in
 which are shown in the figure, and the vertical line
 the object looks again through the hole in the
 same object is seen through the hole and light will
 appear with a small circle in the hole of the object. In
 nature, exactly the reverse will be the case.

The distance is always made up by the rays
 that pass through the hole and that will be the
 case on account of the law of reflection. The rays
 which pass through the hole in the object will be
 scattered in all directions. The rays which pass
 through the hole in the object will be scattered in
 all directions. The rays which pass through the
 hole in the object will be scattered in all directions.

The rays which pass through the hole in the object
 will be scattered in all directions. The rays which
 pass through the hole in the object will be scattered
 in all directions. The rays which pass through the
 hole in the object will be scattered in all directions.

The rays which pass through the hole in the object
 will be scattered in all directions. The rays which
 pass through the hole in the object will be scattered
 in all directions. The rays which pass through the
 hole in the object will be scattered in all directions.

The rays which pass through the hole in the object
 will be scattered in all directions. The rays which
 pass through the hole in the object will be scattered
 in all directions. The rays which pass through the
 hole in the object will be scattered in all directions.

The rays which pass through the hole in the object
 will be scattered in all directions. The rays which
 pass through the hole in the object will be scattered
 in all directions. The rays which pass through the
 hole in the object will be scattered in all directions.

The rays which pass through the hole in the object
 will be scattered in all directions. The rays which
 pass through the hole in the object will be scattered
 in all directions. The rays which pass through the
 hole in the object will be scattered in all directions.

The rays which pass through the hole in the object
 will be scattered in all directions. The rays which
 pass through the hole in the object will be scattered
 in all directions. The rays which pass through the
 hole in the object will be scattered in all directions.

SMALLER FIELD-INSTRUMENTS

POCKET SOLAR COMPASS

POCKET RAILROAD COMPASS

POCKET VERNIER COMPASS

POCKET PLAIN COMPASS

GEOLOGISTS' COMPASS

CLINOMETER COMPASS

MINERS' DIP-NEEDLE COMPASS

DIAL COMPASS

POCKET COMPASSES

WE manufacture a variety of small instruments which are so portable and at the same time so efficient that they are often used, in preference to the larger ones, for preliminary or reconnoissance work.

POCKET SOLAR COMPASS

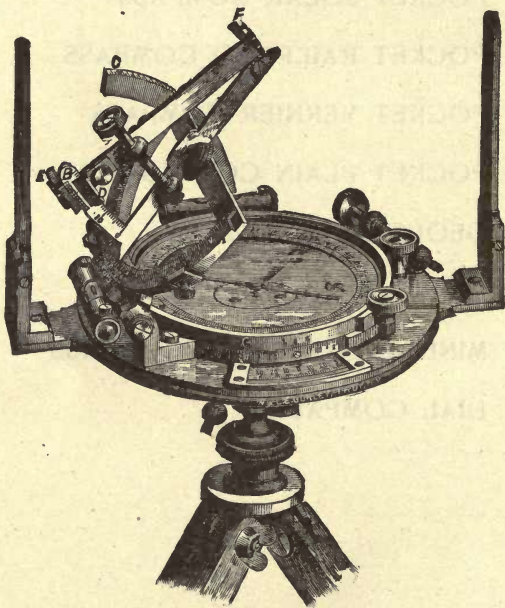

No. 276

Price as shown, with tripod, \$105.00.

The Pocket Solar Compass has a needle three inches long and a limb four and one-half inches in diameter, graduated to half-degrees, figured one row 0 to 180 each way, and reading by one double vernier to single minutes.

The arrangement of the plates is similar to that of the large Solar Compass, the lower plate carrying the sights **PLATES AND SIGHTS** revolving around the upper or compass plate, to which are attached the solar parts, levels, etc. There is a clamp and tangent movement to the horizontal limb and another to the whole instrument about its spindle, both now made with an opposing spring.

The sights are about four and one-half inches high, the distance between them being nearly seven inches. They have a slit and hair in half their height, and are hinged to fold down in packing.

The compass circle is arranged with a pinion and is movable, so as to set off the magnetic declination to five minutes. The needle has a lifting lever by which it is raised against the glass.

The solar apparatus is attached to the upper plate, and **SOLAR PARTS** consists of the usual hour, latitude, and declination arcs, marked respectively A, C, and B in the cut on page 142, with an arm, F F, to the declination arc, carrying the solar lenses and lines.

LATITUDE ARC The latitude arc is graduated to half-degrees, and reads by its vernier to five minutes.

DECLINATION ARC The declination arc is graduated to quarter-degrees, and reads by its vernier to single minutes.

The hour arc is graduated on its inner edge into hours and twelfths, or spaces of five minutes of time, the index on

the declination arc above easily enabling one to read single minutes of time. The hour arc is made **HOUR ARC** movable upon its supporting segment to either side, its outer edge being also graduated on the middle portion to spaces of five minutes of time, and read by a vernier upon the segment to single minutes. In this way the equation of time for any given day is set off at once, and the time indicated by the index of the hour arc made to agree with mean time, or that given by the clock.

The solar lenses and lines are placed as in the larger instruments, the declination arc being also **SOLAR LENSES** reversible as the sun changes from north to south of the equator.

When packed in the case, the declination arc with its arm is detached from the hour arc, and this, together with the latitude arc, folds close to the compass box.

The Pocket Solar Compass is used either upon a ball-spindle with staff mountings, or as shown, upon a light tripod like the other pocket compasses, and often with a small leveling-head with clamp and tangent screws.

Sometimes a side telescope with counterpoise is used in addition to the sight vanes.

The adjustments and use of the Pocket Solar Compass are substantially the same as those of the large Solar Compass already **ADJUSTMENTS** described, and its indications are so accurate that it will give the true meridian within an error of one minute. This fact, taken in connection with the deflection of the magnetic needle, will indicate with certainty the presence and direction of veins of magnetic iron ore.

This instrument is very nearly as accurate as the large Solar Compass, while it is much more portable. It weighs, without box or tripod, four and three-quarters pounds.

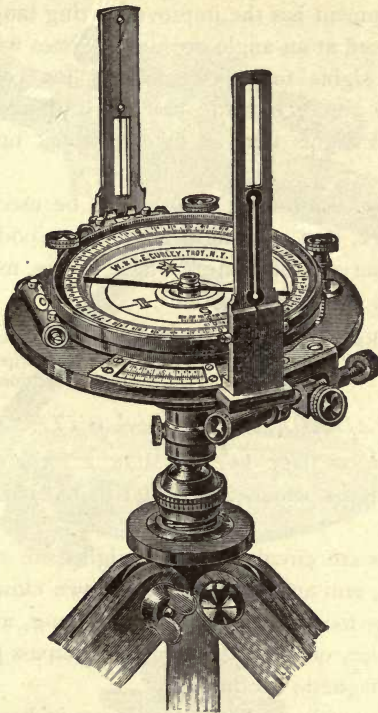

NO. 285

Price as shown, with tripod, \$45.00.

POCKET RAILROAD COMPASS

The instrument shown is a one-vernier Railroad Compass in miniature. The limb is five inches in diameter, graduated to half-degrees, figured one row 0 to 180 each way, and reads by vernier to single minutes. The needle is three and one-half inches long, and the magnetic declination can be set off to single minutes.

This instrument has the improved spring tangent, and the vernier is placed at an angle of thirty degrees with the line of sights. The sights fold down closely for convenience in packing, and are each made half slit and half hair, so that fore and back sights may be taken without turning the instrument.

The Pocket Railroad Compass can be used for a great variety of work, and, with light extension tripod, is especially adapted for surveys of mines, where angles must be taken independently of the needle.

Price of Pocket Railroad Compass No. 285, with staff mountings..	\$40.00
“ “ “ “ “ “ “ with light tripod	45.00
“ “ “ “ “ “ “ with extension tripod .	50.00

POCKET RAILROAD COMPASS WITH TELESCOPE

In the cut on page 147 we show a form of the Pocket Railroad Compass which is adapted to receive the telescopic sight.

The plates are circular and the sights are made half slit and half hair, and are jointed to fold down close to the glass. The needle is four and one-half inches long, and there is an arc with vernier, on the outside of the compass plate, for setting off the magnetic declination.

The instrument has a limb about four inches in diameter, placed inside the compass circle, and reading by a vernier to single minutes. The spindle has a clamp and tangent movement.

The sights being inclined to each other, as shown, a short standard is secured by two milled-head screws to the tops of the sights, and a telescope is thus placed in position, making the instrument in effect a very light Surveyors' Transit.

The attachments of vertical circle, level, and clamp and

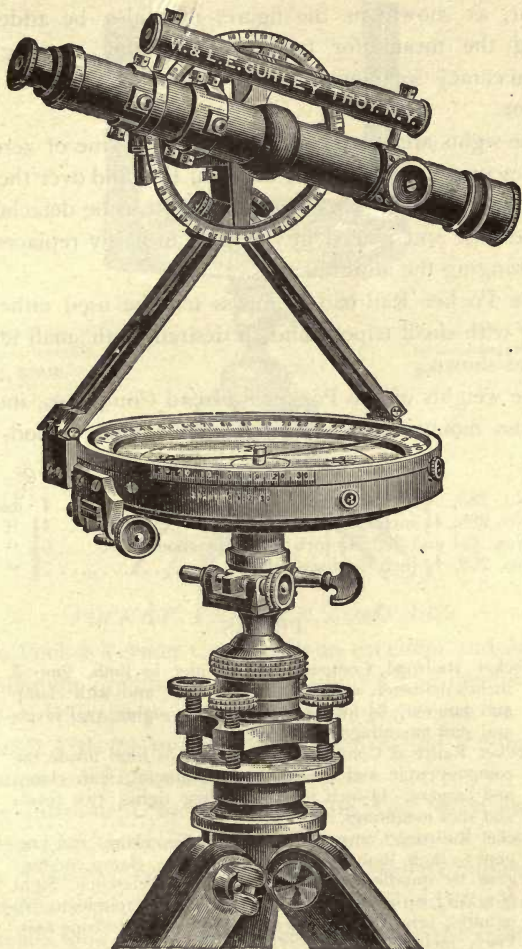

No. 293

Price as shown, \$83.00.

tangent, as shown in the figure, may also be added, furnishing the means for taking grades and running levels with accuracy sufficient for the common practice of the surveyor.

The sights are placed at one side of the line of zeros, and the telescope is thus brought into that line and over the center of the instrument. The short standard can be detached with the telescope and placed in the case, or easily replaced without deranging the adjustments.

The Pocket Railroad Compass may be used either on a staff or with small tripod, and, if desired, with small leveling-head, as shown.

The weights of the Pocket Railroad Compasses, including the brass mountings of the staff, but without tripod, are as follows :

No. 285, 3½-inch Compass, about.....	4 lbs.
No. 288, 4½-inch Compass, about.....	4½ "
Nos. 291 and 292, 4½-inch Compass, about.....	6½ "
No. 293, 4½-inch Compass, about.....	7¼ "

PRICES

No.		
285	Pocket Railroad Compass, one vernier to limb, limb 5 inches diameter, reading to one minute, and with clamp and tangent, 3½-inch needle, folding sights, two levels and staff mountings; see page 145.....	\$40.00
288	Pocket Railroad Compass, one vernier to limb inside the compass circle and reading to one minute, with clamp and tangent, 4½-inch needle, folding sights, two levels and staff mountings.....	33.00
291	Pocket Railroad Compass, 4½-inch needle, clamp and tangent to limb, limb reading to one minute, clamp and tangent to spindle, and fitted with our Telescopic Sight No. 261, with the attachments of vertical circle to five minutes, level, and clamp and tangent to telescope axis. Price, including tripod.....	76.00
292	Same as above, but with Telescopic Sight, No. 262.....	78.00
293	" " " " " " " " No. 262, and with leveling-adopter, as shown on page 147.....	83.00

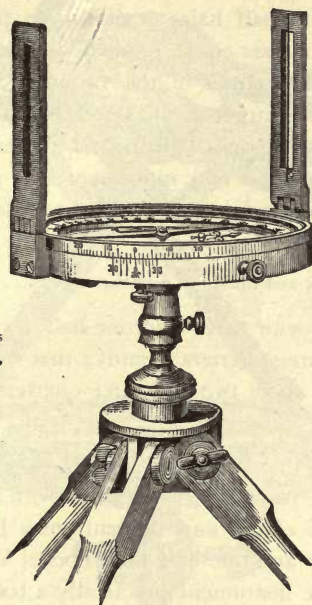

No. 300—Price as shown, $3\frac{1}{2}$ -inch needle, with tripod, \$21.00.

No. 305—With $4\frac{1}{2}$ -inch needle, and tripod \$23.00.

POCKET VERNIER COMPASS

The Pocket Vernier Compass is an excellent and portable instrument for preliminary work, having a fine needle and a vernier and clamping nut, by which the sights can be placed at an angle with the line of zeros, so as to set off the magnetic declination as with the Vernier Compass.

The instrument has folding sights, two levels and staff mountings, and is packed in a mahogany case.

We make two sizes of the Pocket Vernier Compass, having needles respectively three and one-half and four and one-half inches long. In the smaller instrument the sights have a slit in the south vane and a hair in the north vane, for readily finding an object; but in the larger size the sights are

made half slit and half hair, as shown on page 145. Both sizes have the compass circle graduated to half-degrees. In the smaller size the vernier of the variation arc reads to five minutes, and in the larger size to single minutes. The instrument may be used upon a light tripod, if desired.

When so ordered, a rack movement with pinion is added, by which the magnetic declination may be set off more readily.

Price of Rack and Pinion to variation arc..... \$4.00

The compass with three and one-half inch needle weighs about one and three-quarters pounds; that with four and one-half inch needle about two and three-quarters pounds.

POCKET VERNIER COMPASS WITH TELESCOPE

As shown on page 151, a telescope with attached vertical circle, level, and clamp and tangent, may be added to the sights of the four and one-half inch Pocket Vernier Compass, making this little instrument practically a transit compass for land surveying and reconnoissance, capable of running levels and grades with accuracy sufficient for ordinary practice. The sights in this instrument are placed at one side, that the telescope may be directly over the center, and the instrument should have a clamp and tangent movement to the spindle, as shown in the figure. When packed for transportation, the telescope and support are detached from the sights and packed separately in the case. Staff mountings are always furnished with these compasses, and a light tripod, as shown, is very generally added.

The weight of compass No. 312, without tripod, is about four and one-half pounds, and the tripod weighs about four pounds.

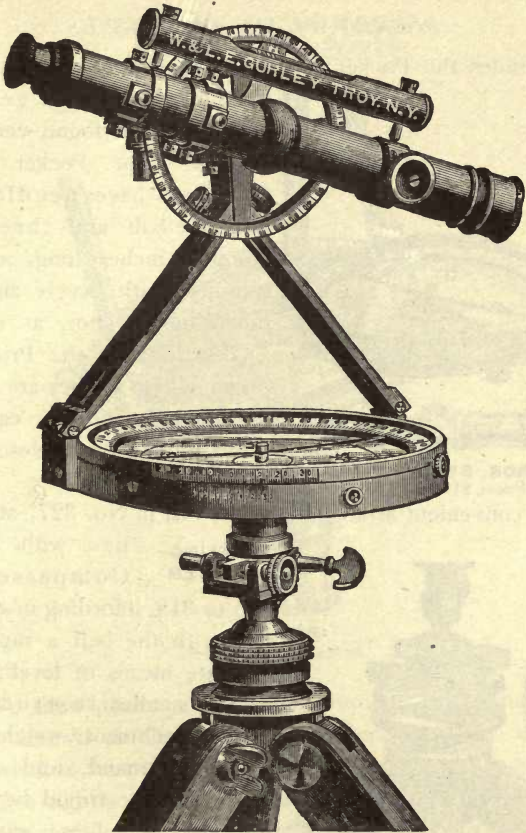

No. 312

Price, complete as shown, \$63.00.

PRICES

- | | | | |
|-----|---|---------|--|
| No. | | | |
| 311 | Pocket Vernier Compass, 4½-inch needle, with clamp and tangent to spindle, and fitted with our Telescopic Sight No. 261, with attachments of vertical circle to 5 minutes, level, and clamp and tangent to telescope axis. Price, including tripod..... | \$61.00 | |
| 312 | Same as above, but with Telescopic Sight No. 262, as shown | 63.00 | |

POCKET PLAIN COMPASSES

Besides the Pocket Vernier Compass, we make a similar instrument without a vernier, which is often found very serviceable. The Pocket Plain Compasses have needles two and one-half and three and one-half inches long, and are supplied with levels and staff mountings or not, as desired, as described in the Price List on page 278. They are packed in a light mahogany case, the sights folding down close to the glass.

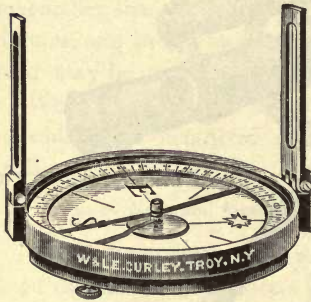

Nos. 316 AND 318
Prices, \$10.00 and \$12.00.

A convenient arrangement is shown in No. 327, at *a*, for

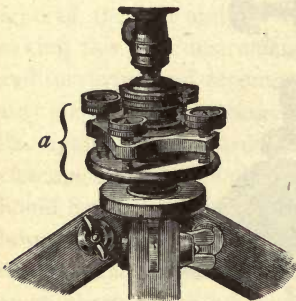

No. 327
Price, \$5.00.

LEVELING-ADOPTER use with Pocket Compasses Nos. 275 to 319, affording in connection with the ball a rapid and accurate means of leveling any of the smaller instruments. The attachment weighs less than one pound, and can be placed on the tripod by merely removing the brass cap. Its value and use are readily apparent.

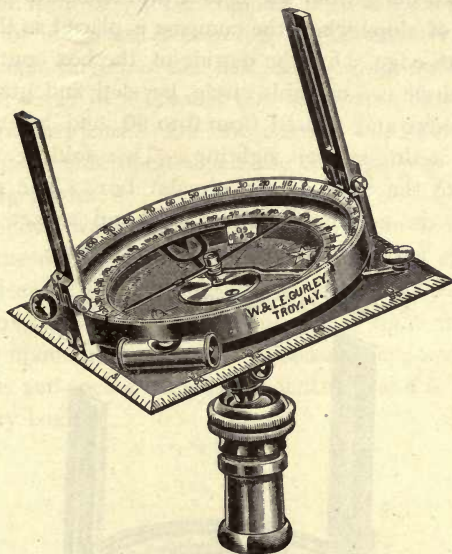
GEOLOGISTS' COMPASS
FOREST SURVEY PATTERN**No. 335**

.Price, as shown, \$24.00.

We show above a popular instrument for topographical work, known as the Geologists' Compass. It is made of aluminum to secure lightness of weight, and has a needle two and five-eighths inches long enclosed with its compass circle in a circular box set upon a base four inches square. The edges of this base are beveled and graduated, two for a tangent scale and the other two with scales of eighths and tenths of inches. The compass circle is made movable, and, by a vernier attached to it on the inside, the magnetic declination can be set off to five minutes. On the south side of the compass face is an arc of one hundred and eighty degrees, figured

on each side of the zero line from 0 to 90. The index point, a pendulum hung from the center-pin, indicates on this arc the angle of slope when the compass is placed so that it rests on its south edge. On the outside of the box containing the compass circle is a movable circle, beveled and graduated on its upper edge and figured from 0 to 90, and having at each quadrant a slit cut for sighting. Two folding sights are attached to the edge of the circular box. The compass is supported on a simple ball-spindle and socket with staff mountings, and is packed in a mahogany box.

CLINOMETER COMPASS

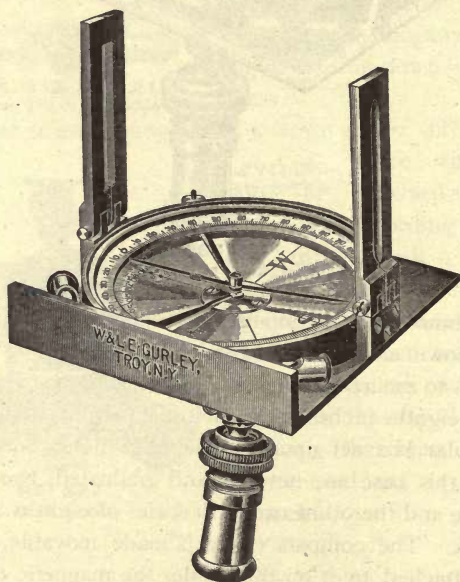

NO. 338

Price, as shown, \$16. See page 155.

CLINOMETER COMPASS

Another form of pocket compass is shown on page 154. It is made of brass, and is known as the Clinometer Compass. It has a needle three and one-half inches long, enclosed with its compass circle in a circular box set upon a base four and one-half inches square. On one edge of this base is placed the rectangular side upon which the compass may be set in determining grades.

The pendulum swinging from the center-pin designates by its index the degree of slope upon the graduated arc on the compass face. Two folding sights are attached to the circular box, and two levels are placed at right angles with each other upon the base. The compass is supported upon a ball-spindle and socket with staff mountings, and is packed in a mahogany box.

MINERS' OR DIP-COMPASS

The Dip-compasses, two forms of which are shown on this page, consist essentially of a magnetic needle so suspended as to move readily in a vertical direction, the angle of inclination, or dip, being measured upon the graduated rim of the compass circle.

When in use, the ring or bail is held by the hand, and the compass box by its own weight assumes a vertical position. It must be held in the plane of the magnetic meridian.

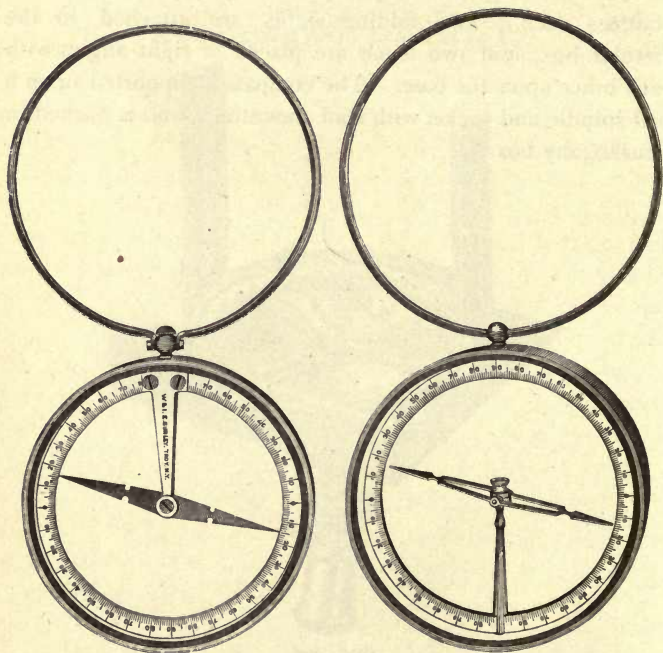

Nos. 340 AND 341
Price, \$16.00.

Nos. 344 AND 345
Price, \$16.00 and \$20.00.

In this position the needle, when unaffected by the attraction of iron, assumes a horizontal line, as shown by the zeros of the circle. When brought over any mass of magnetic iron ore it dips, and thus detects the presence of such ore with certainty.

If the Miners' Compass, Nos. 340 or 341, is held horizontal it serves as an ordinary pocket compass, and indicates the magnetic meridian, in the plane of which it should be held when used to ascertain the dip.

Several forms of this instrument are made. Those shown as Nos. 340 and 341, with a three-inch needle, have the two sides of glass, and are provided with a stop for the needle, which is moved by the little brass knob between the ends of the ring.

The Norwegian Compass, Nos. 344 and 345, is a modification of an instrument used in northern Europe.

It has a needle either three or four inches long, resting upon a single vertical pivot so as to move freely in a horizontal direction. At the same time, being attached to the needle cap by two delicate pivots, one on each side, it is free to dip like the needle of the ordinary Miners' Compass.

There is no instrument made which will indicate the presence of gold or silver.

PRICES

No.		PRICE	POST.
340	Miners' Compass, 3-inch needle, glass on both sides, wood box, stop to needle	\$16.00	\$0.25
341	Miners' Compass, 3-inch needle, glass on both sides, brass covers, stop to needle	16.00	.35
344	Norwegian Compass, 3-inch needle, glass on both sides, brass covers	16.00	.35
345	Same as No. 344, but with 4-inch needle	20.00	.50

There is also on the south side of the face an arc of one hundred and eighty degrees, figured from 0 to 90 on each side of the south or zero line of the face.

A pendulum with index point hung from the center-pin reads this arc when the compass is set up vertical on the raised south edge, thus making it a clinometer or slope-measurer.

The sight is hinged to fold in packing, but when erect it makes taut a silk thread, attached at one end to the sight and at the other to an hour circle above the compass glass, at an angle with the plane of the hour circle equal to that of the latitude of the place where the compass is used. The hour circle is graduated for any required latitude, as a sun-dial, the thread serving as a gnomon to give apparent time with the sun.

The Dial Compass is extensively used in this country in regions where there is local attraction, and it is desirable to have a simple means of determining the meridian independently of the needle.

This can be easily and quickly done by turning the compass, with dial graduated for the latitude of the place, until the shadow of the thread when the compass is held level indicates local time on the dial. The line of zeros will then be in the meridian. The needle may be set to the meridian by laying off the magnetic declination, and any deflection of the needle from the true meridian will indicate the presence of veins of magnetic iron ore.

Extra hour circles, graduated for any latitude and to fit the same compass, can be furnished, and we also supply staff mountings, including ball-spindle and socket, when desired.

Price of extra Hour Circles, each	\$5.00
Price of Staff Mountings, as above	2.50

ALUMINUM DIAL COMPASS

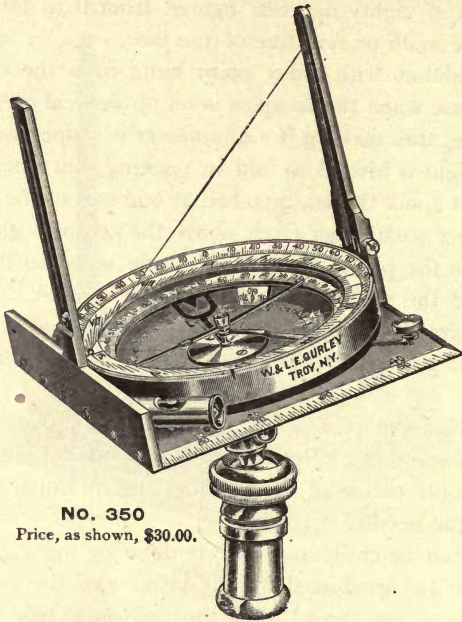

NO. 350
Price, as shown, \$30.00.

The illustration shows an improved form of the Dial Compass, made of aluminum, and differing from our No. 348 in several respects. This instrument is of the same size and has the same parts as the Dial Compass shown on page 158, and has in addition a movable circle graduated on its beveled edge from 0 to 90 degrees. At each quadrant there is a slit cut for sighting, and an open sight is furnished with the compass, to be placed upon the clinometer base when desired, and used in connection with the regular sight. The instrument is mounted upon a small ball-spindle and socket with staff mountings, and is packed in a mahogany box.

LEVELING-INSTRUMENTS

ENGINEERS' Y LEVELS

ARCHITECTS' Y LEVELS

DRAINAGE LEVELS

ENGINEERS' Y LEVELS

OF the different varieties of leveling-instruments, the Y Level is universally preferred by American engineers, on account of its easy adjustment and superior accuracy.

We manufacture five sizes of Y Levels, having telescopes twenty-two, twenty, eighteen, fifteen, and twelve inches in length. The cut on page 163 shows our twenty-inch Level.

The telescope has near its ends two rings of bell metal, turned very truly and of precisely the same diameter. On these rings it rotates in the Ys, or it can be **TELESCOPE** clamped, when the clips of the Ys are brought down upon the rings, by pushing in the tapering pins.

The telescope has a rack and pinion movement to both objective and eyepiece, and an adjustment for centering the eyepiece, shown at A A in the sectional view on page 164. The arrangement for insuring the accurate projection of the objective slide is also shown at C, in the same cut. Both of these are concealed from observation and disturbance by thin bands which screw over them.

A dust guard to the objective slide is now furnished with our eighteen, twenty, and twenty-two-inch Y Levels, without extra charge. This slide is a decided improvement over the shade formerly used. If specially ordered, it can also be placed upon our fifteen-inch and Architects' Levels.

Price of Dust Guard, to order, as above.....\$4.00

SHORT FOCUS The telescopes of our Y Levels, like those of our transits, are now arranged so that they may be focused upon an object much nearer the instrument than as formerly made. Thus

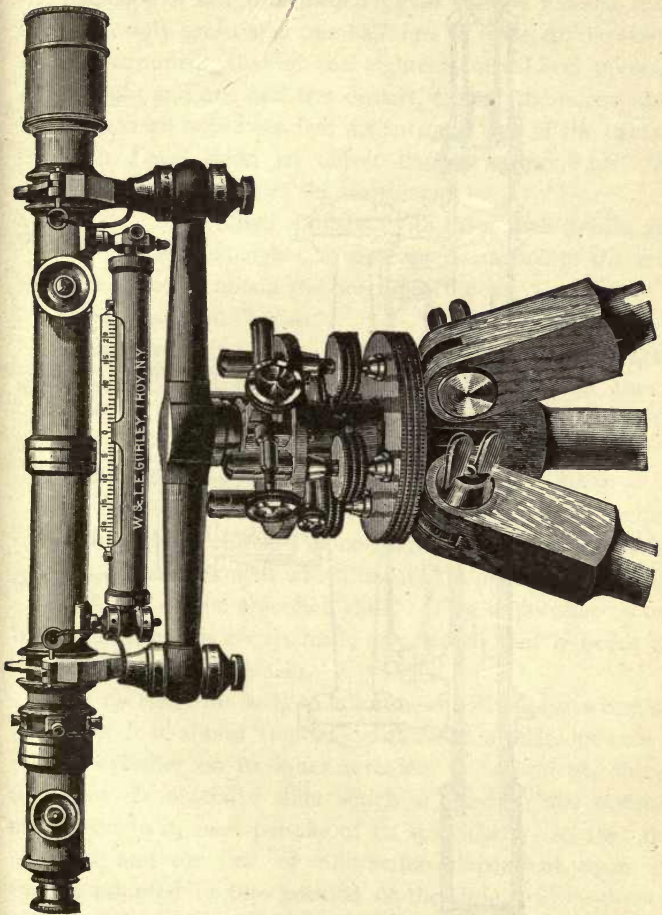

No. 376

20-INCH Y LEVEL

Price, as shown, including Tripod, \$110.00.

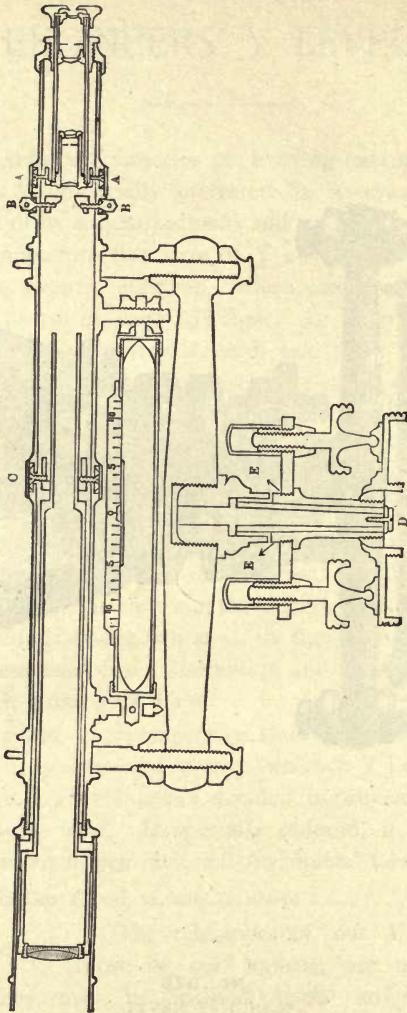

SECTIONAL VIEW OF Y LEVEL

the telescope of our fifteen-inch Level can be focused upon an object only seven and one-half feet in front of the center of the instrument, that of the eighteen-inch Level upon an object eight and one-half feet distant, that of the twenty-inch Level upon an object ten feet distant, and that of the twenty-two-inch Level upon an object twelve and one-half feet distant from the center of the instrument.

COMPASS A small compass, with three-inch needle and without sights, is sometimes attached to the telescope and used to obtain the bearing of lines.

Price of attached Compass \$10.00

HORIZONTAL CIRCLE A horizontal circle three and one-half inches in diameter can be fitted to the leveling-head of the Y Level. The circle is graduated to degrees, and is read by vernier to five minutes.

Price of Horizontal Circle, as above. \$15.00

The interior construction of the telescope will be understood from the sectional cut on page 164, which shows the **OBJECTIVE SLIDE** adjustment which insures the accurate projection of the objective slide. This is peculiar to our instruments, and is always made so perfectly that it needs no attention from the engineer.

The necessity for such an adjustment will appear when we state that it is almost impossible to make a telescope tube a perfect cylinder on its inner surface. It is evident, therefore, that the objective slide which is fitted to this surface, and moves in it, must partake of its irregularity, so that the objective and the line of collimation dependent upon it, though adjusted in one position of the slide, will be thrown out when the slide is moved out or in.

To prove this, let any level be selected which is constructed in the usual manner, and the line of collimation

adjustment be made upon an object as near as the range of the slide will allow. Then let another object be selected as distant as may be clearly seen ; upon this rotate the wires, and they will generally be found out of adjustment, sometimes to a degree fatal to any confidence in the accuracy of the instrument. The arrangement adopted by us to correct this imperfection, and which perfectly accomplishes its purpose, is shown in the sectional cut.

Here are seen the two bearings of the objective slide, one being in the narrow ring slightly less in diameter than the main tube, the other in the adjustable ring shown at C, suspended in the middle of the telescope by four screws.

Advantage is here taken of the fact that the rays of light are converged by the objective, so that none are obstructed by the contraction of the slide except those which diverge, and which ought always to be intercepted and absorbed in the blackened surface of the interior of the slide.

In such a telescope the perfection of movement of the slide depends entirely upon its exterior surfaces at the point of the two bearings. These surfaces are accurately turned, concentric and parallel with each other, and, being fitted to the rings, it is only necessary to adjust the position of the smaller ring so that its center will be coincident with the optical axis of the objective. When this has been done no further correction will be necessary, unless the telescope should be severely injured. The manner in which the adjustment of the objective slide is effected will be considered when we speak of the other adjustments.

As seen in the cut, the telescopes of our eighteen, **RACK AND PINION** twenty, and twenty-two-inch Levels are furnished with rack and pinion movement to both objective and eyepiece.

The advantages of an eyepiece pinion are that the eyepiece can be moved without danger of disturbing the telescope, and that the wires are more certainly brought into distinct view, so as to avoid any error of observation arising from the instrumental parallax.

The level-tube, with ground vial and a scale, is attached to the under side of the telescope, and furnished at different ends with the usual movements in both horizontal and vertical directions.

The aperture of the tube, through which the glass vial is seen, is about five and one-quarter inches long, and is crossed at the middle by a rib or bridge which greatly strengthens the tube.

The level-vial is a glass tube with an even bore from end to end, and finely ground on its inner surface, so that the run of the air bubble may be uniform throughout its whole range. The level-scale, which extends over the whole length and is set close to the glass, is graduated to tenths of an inch and figured in each direction at every fifth division, from 0 at the middle of the bridge.

The sensitiveness of a ground level is best determined by an instrument called a level-tester, consisting of a bar with two Ys to hold the level-tube, and pivoted at one end, while at the other end is a micrometer wheel attached to the top of a fine threaded screw which raises the end of the tester very gradually. The number of divisions passed over on the perimeter of the wheel, in carrying the bubble over a tenth of an inch on the scale, is the index of the delicacy of the level. In the tester which we use, a movement of ten divisions of the wheel to one of the scale indicates the degree of delicacy generally preferred for railroad engineering. For canal work a more sensitive bubble is often required, as, for

instance, one of five to seven divisions of the wheel to one of the scale.

The Ys of our levels are large and strong, of the best bell metal, and each has two nuts adjustable with the steel pin.

Ys The clips are brought down on the rings of the telescope tube by the Y pins, which are tapering so as to clamp the rings firmly. The clip of one of the Ys has a pin projecting from it, which, entering a recess in the edge of the ring, insures the horizontal position of the cross-wire.

LEVEL-BAR The level-bar is round, of the best bell metal, and shaped for greatest strength in the parts most liable to sudden strains. Connected with the level-bar is the head of the leveling-socket.

The socket is compound. The inner spindle, D (see page 164), upon which the whole instrument is supported, is of steel, nicely ground so as to turn evenly and firmly in a hollow cylinder of bell metal; **SOCKET** this again has its exterior surface fitted and ground to the main socket, E E, of the leveling-head.

The cylinder is held upon the spindle by a washer and screw, the head of the latter having a hole in its center through which the string of the plummet is passed.

The upper part of the instrument, with the socket, may be detached from the leveling-head, and this also, as is the case with all our instruments, can be unscrewed from the tripod head; but all our Y Levels are packed in the case complete with leveling-head, experience having shown that there is thus less danger of injury in transportation. It will be seen from the cut that the arrangement just described allows long sockets, and yet brings the whole instrument down as close as possible to the leveling-head, both objects of great importance in the construction of any instrument.

The leveling-head has the same plates and leveling-screws as described in the account of the transit (see **LEVELING-HEAD** page 19). The tangent screw has also an opposing spring, as there described.

For the fifteen-inch Level we make a leveling-head similar to that used with the lighter Engineers' Transit.

TO ADJUST THE LEVEL

The adjustment of the objective slide is peculiar to our instruments, and is always made by us so permanently as to need no attention at the hands of the engineer, unless in case of derangement by accident.

To adjust the objective slide, the maker selects an object as distant as may be distinctly observed, and upon it adjusts **OBJECTIVE SLIDE** the line of collimation, in the manner described on page 171, making the intersection of the wires to rotate without passing either above or below the point or line selected. In this position the slide will be drawn in nearly as far as the telescope tube will allow.

With the pinion head he then moves out the slide until an object, distant about ten or fifteen feet, is brought clearly into view. Again rotating the telescope in the Ys, he observes whether the wires will reverse upon this second object.

Should this be the case, he will assume that, as the line of collimation is in adjustment for these two distances, it will be for all intermediate ones, since the bearings of the slide are supposed to be true and their surfaces parallel with each other.

If, however, either or both wires fail to reverse upon the second point, he must, by estimation, remove half the error by the screws at C (see page 164), at right angles with the wire to be corrected, remembering that, on account of the inverting power of the eyepiece, he must move the slide in

the direction which apparently increases the error. When both wires have been thus treated, the line of collimation is adjusted on the near object, and the telescope again brought upon the most distant point. The tube is again rotated, the reversion of the wires upon the object once more tested, and the correction, if necessary, made in the same manner.

He proceeds thus until the wires will reverse upon both objects in succession; the line of collimation will then be in adjustment at these and all intermediate points. By bringing the screw heads to a firm bearing upon the washers beneath them, the adjustable ring will be fastened so as to need no further attention for many years. The thin brass ferule is then screwed over the outside ring, concealing the screw heads and obviating all danger of their disturbance.

In making this adjustment, it is always best to bring the wires into the center of the field of view by moving the screws A A, see page 164, working in the centering-ring of the eyepiece tube.

Should the engineer desire to make the adjustment of the objective slide, it will be necessary to remove the level-tube, in order that the screw immediately above its scale may be accessible.

The adjustments which are common to all Y Levels, and with which the engineer should be familiar, are:

To adjust the line of collimation, or, in other words, to bring the cross-wires into the longitudinal axis, so that their point of intersection will remain on any given point during an entire rotation of the telescope.

To bring the level-bubble parallel with the bearings of the Y rings, or with the longitudinal axis of the telescope.

To adjust the Ys, or to bring the bubble into a position at right angles with the vertical axis of the instrument.

permanent, the cover being screwed on again to protect it from derangement.

To adjust the level-bubble: Clamp the instrument over either pair of leveling-screws, and bring the bubble into the middle of the tube. Turn the telescope **LEVEL-VIAL** in the Ys, so as to bring the level-tube to one side of the middle of the bar. Should the bubble run to the end, it would indicate that the vertical plane passing through the middle of the bubble was not parallel with that drawn through the axis of the telescope rings.

To correct the error, bring the bubble, by estimation, half-way back by the capstan-head screws on each side of the level-holder, placed usually at the objective end of the tube. Again bring the level-tube over the middle of the bar and the bubble to the middle, turn the level to either side, and, if necessary, repeat the operation until the bubble will keep its position when the tube is turned half an inch or more to either side of the middle of the bar.

The necessity for this operation arises from the fact that, when the telescope is reversed end for end in the Ys in the other and principal adjustment of the bubble, we are not certain of placing the level-tube in the same vertical plane, and therefore it would be almost impossible to effect the adjustment without a lateral correction.

Having now largely removed the initial difficulties, we proceed to make the level-tube parallel with the bearings of the Y rings.

To do this, bring the bubble into the middle with the leveling-screws, and then, without jarring the instrument, take the telescope out of the Ys and reverse it end for end. Should the bubble run to either end, lower that end, or, what is equivalent, raise the other by turning the adjusting-nuts on one end

of the level until, by estimation, half the correction is made. Again bring the bubble into the middle by the leveling-screws, and repeat the whole operation until the reversion can be made without causing any change in the bubble.

It would be well to test the lateral adjustment and make such correction as may be necessary in that, before the horizontal adjustment is entirely completed.

To adjust the Ys: Having made the previous adjustments, it remains to bring the level into position at **Ys** right angles with the vertical axis, so that the bubble will remain in the middle during an entire revolution of the instrument.

To do this, bring the level-tube directly over the middle of the bar and clamp the telescope in the Ys, placing it as before, over two of the leveling-screws. Unclamp the socket, center the bubble, and turn the instrument half-way around, so that the level-bar may occupy the reverse position in respect to the leveling-screws beneath.

Should the bubble run to either end, bring it half-way back by the Y nuts on either end of the bar. Place the telescope over the other pair of leveling-screws, bring the bubble again into the middle, and proceed as above described, changing to each pair of screws successively until the adjustment is very nearly perfected, when it may be completed over a single pair.

The object of this approximate adjustment is to bring the upper plate of the leveling-head into a position as nearly horizontal as possible, in order that no essential error may arise in case the level, when reversed, is not brought opposite its former position. When the level has been thus completely adjusted, if the instrument is properly made and the socket

well fitted, the bubble will reverse over each pair of screws in any position.

Should the engineer be unable to make it work correctly, he should examine the outside socket to see that it is set securely in the main socket, and also notice that the clamp does not bear upon the ring which it encircles. When these are correct, and the error is still manifest, it will probably be found in the imperfection of the interior spindle.

The adjustments having been completed, and the instrument being precisely level, the engineer should rotate the telescope in the Ys until the pin on the clip of the Y will enter the little recess in the ring to which it is fitted, and by which the horizontal position of the cross-wire is insured.

When the pin is in its place the horizontal wire may be compared with any level line, and in case it should not be parallel with it, two of the cross-wire screws that are at right angles with each other may be loosened and, by the screws outside, the cross-wire ring turned until the wire is horizontal. The line of collimation must then be corrected again, and the adjustments of the level will be complete.

TO USE THE LEVEL

When using the instrument, the legs of the tripod must be set firmly into the ground, and the bubble brought over each pair of leveling-screws in turn and leveled in each position, any necessary correction being made in the adjustments.

Care should be taken to bring the wires precisely into focus, and the object distinctly into view, so that all errors of parallax may be avoided. In all instances, the wires and object should be brought into view so perfectly that

the cross-wires will appear to be fastened to the surface, and will remain in that position however the eye is moved.

In running levels it is best, wherever possible, that equal fore and back sights should be taken, to avoid any error arising from the curvature of the earth, and also to correct any errors of adjustment in the instrument.

If the socket of the instrument becomes so firmly set in the leveling-head as to be difficult of removal, the engineer should place the palm of his hand under the Y nuts at each end of the bar and give a sudden upward blow to the bar, taking care to hold his hands so as to grasp it the moment it is free.

If there is any roughness in the movement of the objective slide, it may be looked for in three places :

1. Remove the four screws that attach the pinion strap to the telescope. See that the pinion turns freely in its socket ; if it does not, there is dirt in the bearing which is cutting its surface. Remove the nut at the end of the pinion rod and knock the pinion out of its head with a block of wood. The scratched surface can be rubbed smooth with the back of a knife blade. Put a little tallow on the bearings and replace the parts.

2. While the pinion is out see that the slide moves freely in or out. If it scratches, rub it smooth.

3. If the pinion movement and slide are found in good order, the roughness may be on the slide of the slot opposite the rack, on the edge which bears upon the back of the pinion socket. Rub this smooth and apply a little tallow.

We now use in the objective slides of all our telescopes, as well as in the pinion sockets, an anti-friction bearing which, after a trial of several years, has proved to be a complete preventive of the abrasion or fretting of the surfaces above mentioned.

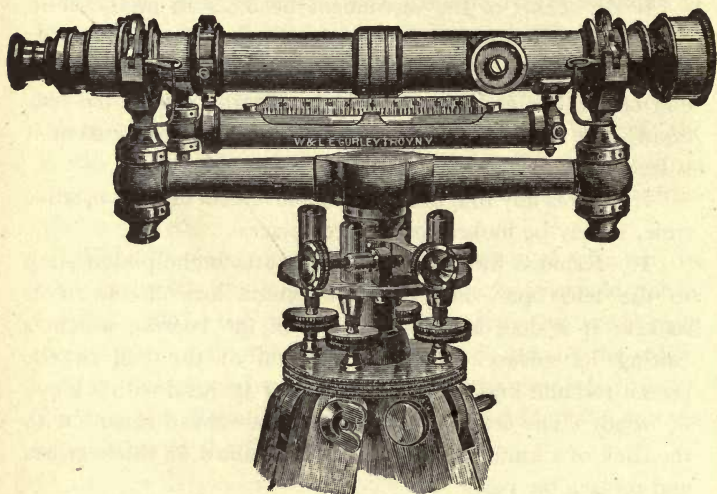

NO. 378

15-INCH Y LEVEL. Price as shown, with tripod, \$90.00.

The fifteen-inch Level, as shown, has the same arrangement of sockets, tripod, etc., as the larger levels, but has no pinion movement to the eyepiece. The shade to the objective is removable. The leveling-head remains attached to the spindle, and is packed with it in the box. The instrument is somewhat smaller and lighter than the other sizes.

**SIZES
AND WEIGHTS**

The average weights of the different sizes of our Y Levels, exclusive of the tripod, are about as follows :

22-inch telescope, with leveling-head	14 $\frac{1}{4}$ lbs.
20-inch " "	13 $\frac{1}{2}$ lbs.
18-inch " "	13 $\frac{1}{4}$ lbs.
15-inch " "	11 $\frac{1}{4}$ lbs.
Architects' Level, "	6 $\frac{1}{2}$ lbs.

ARCHITECTS' LEVEL

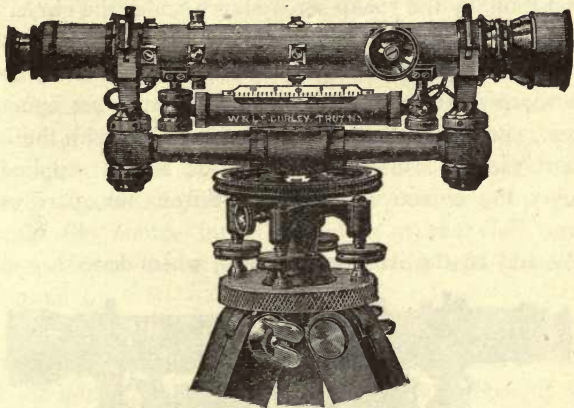

No. 380

Price as shown, with tripod, \$50.00.

The figure represents a level, introduced by us in 1874, which is very largely used by architects, builders and mill-wrights, as well as by engineers and surveyors, in the grading of streets, sewers and drains.

The instrument has a telescope twelve inches in length, furnished with rings and Ys like that of the larger levels and adjusted in the same manner. As now made, the telescope can be focused upon an object only six and one-half feet from the center of the instrument.

The leveling-head has the screws and clamp to the spindle, but no tangent movement. It has also a horizontal circle three inches in diameter, fitted to the upper end of the socket and turning readily upon it. The circle is graduated to degrees, figured from 0 to 90 each way, and is read to five minutes by a vernier which is fixed to the spindle.

The telescope is directed to any object by hand, the spindle turning readily in its socket; but it can be clamped in any position by the clamp screw shown under the circle.

The instrument is placed either upon a light tripod as shown, or on a small triangular plate called a trivet, having three sharp steel points by which it is firmly set upon any surface. Both tripod and trivet are furnished with the level. A short piece of tube called a shade is also supplied, to put over the objective to protect it from the glare of the sun.

We add to the Architects' Level, when desired, a clamp

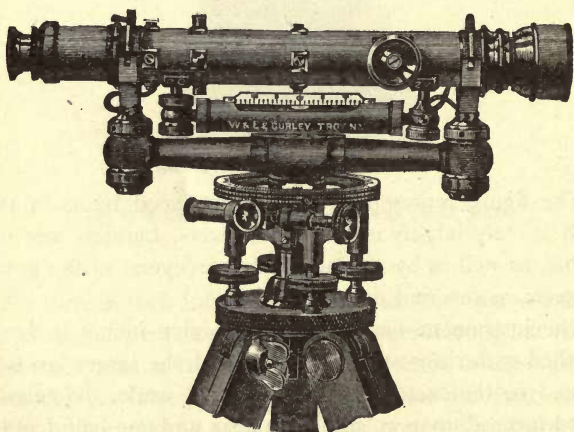

No. 381

Price as shown, with clamp and tangent, \$65.00.

and tangent movement, which allows the instrument to be clamped more securely, and a movement in a horizontal plane to be made more accurately. See page 178.

ADJUSTMENTS The adjustments of the Architects' Level are made exactly as described in the account of the larger levels. They are not liable to derangement, and will ordinarily require but little attention.

TO USE THE ARCHITECTS' LEVEL

The instrument should be set firmly upon the tripod or trivet, in a position as nearly level as practicable, the telescope placed over either pair of leveling-screws, and the bubble brought into the middle by turning the opposite screws either in or out as may be needed, and both screws brought to a bearing in the little cups underneath. Having brought the bubble into the middle of the vial, turn the telescope over the other pair of screws and repeat the operation.

The instrument having been carefully leveled, focus the eyepiece and objective upon the object as before described, and the horizontal cross-wire will give any number of points required, which will all be in the same level plane.

A board held erect will answer as a rod, and a pencil line drawn across it at the place cut by the horizontal wire will give the height of the starting-point. Any different points on the rod, either above or below that indicated by the cross-wire, will show the difference in height of the various points observed, as compared with the starting-point.

In laying off angles with the Architects' Level, the **LAYING OFF** bubbles should first be brought into the middle as before described, and the vertical cross-wire made to cut the object or line from which the angle is **ANGLES**

to be taken. Then, the spindle being clamped by the milled-head screw under the circle, the circle is turned around by hand until the zero lines of both circle and vernier are made to coincide. Loosen the clamp screw and turn the telescope to the point desired, and the angle between the two points will be read off on the circle.

By the use of the vernier angles can be read on the circle to five minutes, but ordinarily only even angles will be taken and only the middle line of the vernier used.

The point underneath the center of the instrument is indicated by the point of the plummet suspended from the tripod.

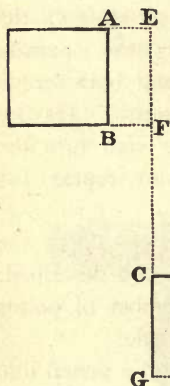

In many cases, after the walls of a building have been carried up to a considerable height, it becomes difficult to set up the tripod, and in this case the level is screwed upon the trivet, which can be set upon the wall or a piece of board tacked to the building, or indeed upon any surface nearly level and not less than six inches square.

To illustrate the value of this instrument in laying out the sites of buildings, suppose it is desired to erect a building, C D, at right angles with a building, A B, and at a given distance from its front.

First set up the level at E, and carefully center the bubble, the point of the plummet below indicating the required distance of the side of the new building from the front, A B. Measure the same distance at the other corner of A B, and, having erected the rod, sight upon it with the telescope and clamp to the spindle.

Now carry the rod the required distance from B, and

move it from side to side until it is again in line with the telescope, as at C.

Remove the instrument, and having carefully set it over the point C, by the plummet, and brought the bubble into the middle as before, set the telescope again upon the rod place at E or F, and clamp to the spindle. Bring the zeros of the circle and vernier to coincide, unclamp, and turn the vernier to ninety degrees; this will give a point, D, at any required distance from C, and C D will be the side of the proposed building. The side, C G, is determined by turning the telescope around until the vernier is in line with the other zero of the circle, and thus the corner, C, and the two sides, C D and C G, are at once set off, and the remaining corner, H, easily ascertained by making D H and G H equal to C G and C D respectively.

Other uses of the level, as the setting of floor timbers, of window- and door-sills and the leveling of floors, will readily occur to one who has been engaged in building. To the millwright such a level is almost indispensable in the aligning and leveling of shafting, in ascertaining the fall of water obtainable and in determining the overflow of land by a mill pond. The farmer will find it of value in locating and laying out drains, ascertaining the height of springs and similar work.

This level has become widely known, and its cheapness, simplicity and excellence have created a great demand for it.

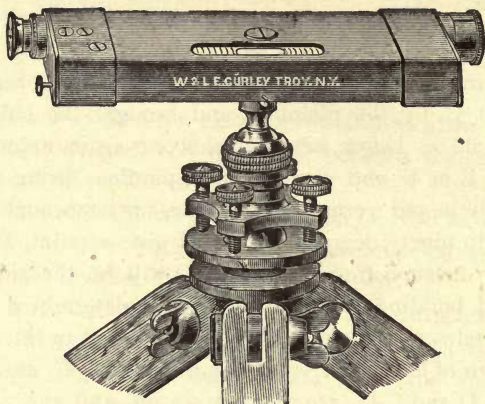

No. 387

Price as shown, \$25.00

DRAINAGE LEVEL. (New Pattern.)

No. 387 represents a level combining great simplicity and compactness with real efficiency, at a very moderate cost. The telescope is about nine inches long and is made especially for this instrument, being achromatic, of low but sufficient power, and giving good light and definition. The cross-wires are fixed in the eyepiece so that they are not easily disturbed. The level, telescope and socket are enclosed in a strong outside case of brass, about seven and one-half inches long, two and one-quarter inches wide and one and one-half inches high.

The ends of the case are thickened and made parallel each to each, on the upper and under sides.

A ball attachment, by which the instrument is made approximately level, screws into a spindle which is within the case. The precise leveling is done by the leveling-screws, as shown. When desired, the leveling-head can be dispensed with, and the instrument leveled by the ball alone.

A compass with three-inch needle is added to the Drainage Level, when desired. This is fitted to the upper surface of the case and can be removed at pleasure, and while it does not interfere in any way with the reading of the level-vial, it furnishes a ready means of determining the bearing of lines or of measuring angles by the needle.



This level is adjusted almost as simply as an ordinary masons' or builders' level, in the following manner: The spirit-level, by reversing from end to end on the lower faces of the case, and making necessary corrections by the screws at the eyepiece end, marked "L" on opposite faces and in line with the level-tube; the telescope, by applying the opposite faces alternately to the same surface, and bringing the telescope cross-wires by two screws marked "T," one on each face, so as to cut the same point in both positions of the case. A small block of wood, having a screw-thread that fits the top of the ball attachment, is furnished with the instrument, for use in making the above adjustments.

When the ball is screwed firmly to the spindle and the instrument leveled, it should remain level when reversed upon its spindle in any direction. If it does not, correct the error by the two screws on the opposite sides of the case, marked "S." Should the cross-wires be indistinct or out of focus, unscrew the cap of the eyepiece and turn the setting of the lens around in either direction until the wires are clearly seen, when the cover may be replaced.

Of course, these adjustments are always made by the maker, and are not liable to derangement in the careful use of the level.

To clamp the instrument on the spindle, turn the small milled-head screw at the eyepiece end. To screw the ball attachment to the spindle, press in the spring catch at the bottom of the case, and the ball can then be easily screwed in.

The advantages of this level in the work of the farmer, manufacturer and builder will be apparent. Drains can be located and leveled, the height of springs ascertained, and the accurate level of lines of shafting, floor timbers and sills be determined.

The Architects' leveling-rod, hereafter described, is intended for use with this instrument, when desired.

PRICES

No.			
385	Drainage-Level, with staff mountings.....		\$15.00
386	“ “ with plain tripod.....		20.00
387	“ “ with tripod and leveling-screws.....		25.00
388	“ “ with tripod and leveling-screws, and with compass and clamp-screws.....		30.00

TRIPODS

LEATHER CASES AND POUCHES

LEVELING-RODS

RANGING-POLES

ROD LEVEL

PLANE-TABLES

ALIDADES

BATSON SKETCHING-CASE

CURRENT METERS

HAND LEVELS

CHAINS

TAPES

TRIPODS

IN THE tripods of all our instruments, the upper part of the leg is flattened and slotted to fit closely on each side of a strong tenon projecting from the under side of the tripod head, to which it is firmly held by a strong brass bolt, with large head and thumb-nut on opposite sides of the leg. The tripod head is of the best bell metal, the tenons and upper part being cast in one piece and firmly braced together. The legs are round, and taper in each direction toward the head and point. The point or shoe is a tapering brass ferrule, having an iron end. It is cemented and firmly riveted to the wood.

The legs of all our tripods are made of straight-grained hardwood, and are about four feet eight inches long from head to point.

We make four sizes of tripods with solid legs, as follows:

The heavy tripod, No. 400, has a metal head four and one-quarter inches in diameter, with legs one and three-eighths inches in diameter at the top, one and three-quarters at the swell, and one and one-eighth near the point. This is used with the Engineers' Transit and with the larger Y Levels.

The medium-size tripod has a head the same diameter as the former, and legs which are one and one-eighth inches in diameter at the top, one and five-eighths at the swell, and one and one-sixteenth near the point. This tripod is used with the Surveyors' Transit, the light Engineers' Transit and the fifteen-inch Level.

The compass tripod, No. 415, has a head about three inches in diameter, and legs which are about one inch in

diameter at the top, one and three-eighths at the swell, and seven-eighths near the point. This tripod is used with the various compasses and with the Vernier Transit Compass.

PLAIN TRIPODS

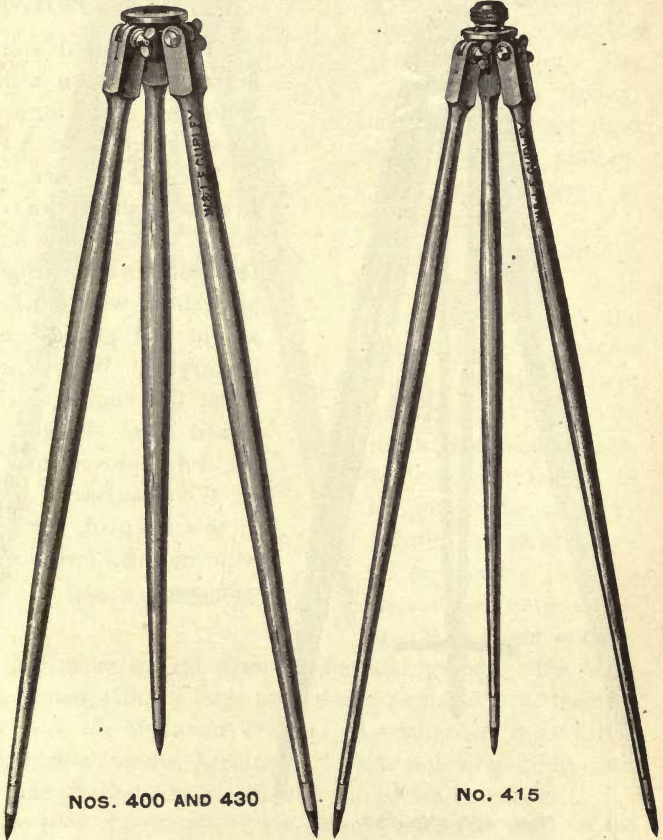

NOS. 400 AND 430

No. 415

The pocket compass tripod is the same pattern as No. 415, but has smaller head and legs. The legs are nearly three-quarters of an inch in diameter at the top and bottom, and one and one-eighth at the swell.

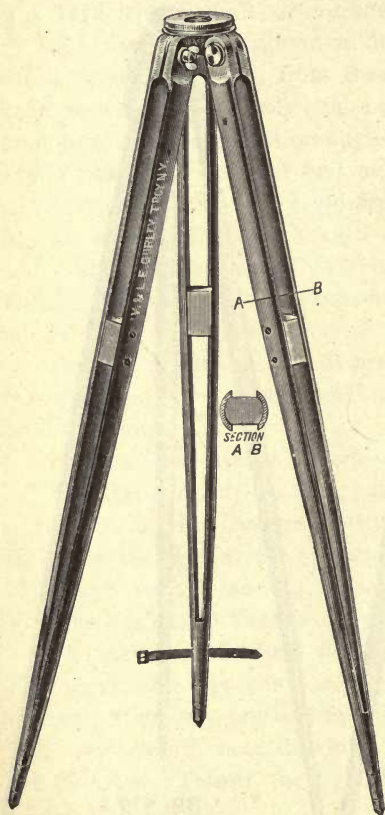

Nos. 405 AND 435

SPLIT-LEG TRIPOD

The improved split-leg tripod is shown in the engraving. The form is shown in section at A B.

The legs are of straight-grained hardwood, and by the new form stiffness and strength are gained, with reduced weight and greater ease in carrying. We are confident that engineers will regard these changes as decided improvements.

We make several sizes of this tripod, for use with transits, levels and compasses.

EXTENSION TRIPOD

In No. 410 is shown a decided improvement on the old pattern of extension tripod, which has proved so popular. The new tripod is lighter, stronger and more rigid than the old pattern. The form is shown in section at A B.

The new tripod can be carried more easily than the old, and the shape of the side pieces allows the middle piece to be clamped firmly with the two bands and screws, while slight changes in length can be made by twisting the middle piece up or down. The legs are clamped to the tripod head with thumb-nuts.

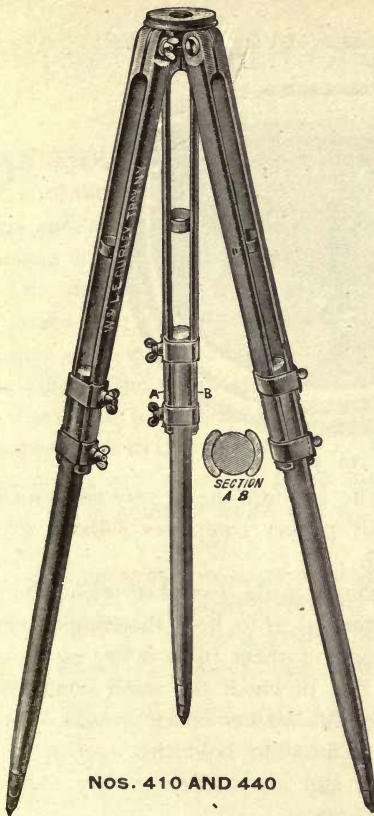

NOS. 410 AND 440

We make several sizes of extension tripods. The large size is used with the large transits and levels, and the medium size with the Mountain Transit. A smaller size is used with the smaller transits, Architects' Levels and large compasses, and the smallest size is used with the pocket compasses.

For prices of plain, split-leg and extension tripods, see pages 280 and 281 of the Price List.

LEATHER CASES AND POUCHES

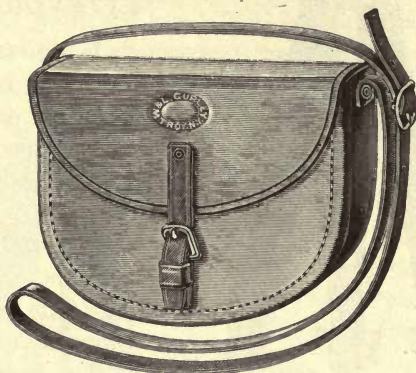

No. 490

The pouch shown in the cut furnishes a very convenient method for carrying small pocket compasses without telescopes, as Nos. 288 to 350.

These pouches are strongly made, furnished with adjustable sling strap, and so arranged as to hold the compass and its mountings firmly and protect them from injury in transportation. The wooden box in which the small compasses are packed is omitted when the leather pouch is used. The leather cases, however, are fitted to hold the wooden box containing the instrument, and are used with any transit, level, compass, or pocket compass.

We have the best facilities for making all kinds of leather work to order, and can promptly furnish anything in the line of cases or pouches for surveying instruments. We also make to order canvas cases for carrying tripods and leveling-rods.

For prices of leather cases and pouches, see page 282 of the Price List.

LEVELING-RODS

ON THE following pages we give cuts and descriptions of the leveling-rods commonly used by American engineers and surveyors, which are manufactured by us in large numbers and kept constantly in stock.

Our facilities for the manufacture of leveling-rods have for many years surpassed those of all other makers. The greatest care is exercised in the selection, preparation and seasoning of the wood, and special appliances and machinery for the work have been constructed at great cost. Many improvements in design and in the construction of parts have been made, with a view to producing the best results obtainable, and in point of finish and accuracy our rods are unexcelled.

For many years we have made to order special rods to designs furnished, which have been used in the most critical work with perfect satisfaction. We are prepared to make rods of any design to order.

PHILADELPHIA ROD

No. 500

This rod is made in two parts, each about three-quarters of an inch thick by one and one-half inches wide and seven and three-tenths feet long, the parts connected by two metal sleeves, the upper one of which has a clamp screw for fastening the two parts together when the rod is extended for a higher reading than seven feet.

Both sides of the back strip and one side of the front are recessed one-sixteenth of an inch below the edges. These surfaces are painted white, graduated into feet, tenths and

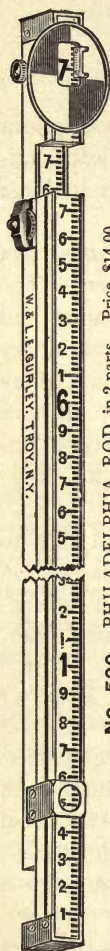

No. 500. PHILADELPHIA ROD, in 2 parts. Price, \$14.00.

hundredths of a foot, and the feet and tenths figured. The graduations and figures are slightly impressed on the recessed surfaces, thus increasing their durability.

The edges of the rod and the corners of the brass mountings are rounded, for ease in handling.

The front piece reads from the bottom upward to seven feet, the foot figures being red and the tenth figures black. When the rod is extended to full length the front surface of the rear half reads from seven to thirteen feet, and the whole front of the rod is figured continuously and becomes a self-reading rod, thirteen feet long, reading to hundredths of a foot.

The back surface of the rear half is figured from seven to thirteen feet, reading from the top down. It has a vernier scale by which the rod is read to thousandths of a foot as it is extended. The target is round, made of brass raised on the perimeter to increase its strength, and is painted in white and red quadrants. It has also a vernier scale on its chamfered edge, reading to thousandths of a foot.

When a level of less than seven feet is desired, the target is moved up or down the front surface, the rod being closed and clamped; but when a greater height is required the target is fixed at seven feet and the rear half extended, the vernier scale on the back giving the readings like those of the target to thousandths of a foot.

PHILADELPHIA ROD

In three parts. No. 501

To provide a rod of the same general design and use as the Philadelphia rod, but capable of being closed to shorter length, we have recently introduced the Philadelphia rod in three parts. This rod is five and three-tenths feet long when closed, and when extended reads to thirteen feet.

In reading above five feet the rear part is extended, the readings being made on the graduated edges of the rod by vernier to thousandths of a foot.

When fully extended the front surface becomes a self-reading rod to thirteen feet, the graduations being to hundredths of a foot.

On account of ease in transportation, as well as the general character and excellence of this rod, we believe it will be approved by those who use it.



No. 501. PHILADELPHIA ROD, in 3 parts. Price, \$18.00.

BOSTON ROD

No. 503

This rod is formed of two pieces, each about six feet long, sliding easily by each other in either direction.

One side is furnished with a clamping piece and screw, with a small vernier at each end; the other or front piece carries the target, and has on each side an inlaid strip upon which graduations of feet, tenths and hundredths are marked and figured.

The target is a disk of brass raised on its perimeter, fastened on the front half, and painted red and white, its middle line being just three-tenths of a foot from the end of the rod.

Each tenth graduation is figured decimally in three figures, or to hundredths of a foot, and by the verniers is read to thousandths.

The target being fixed, when any height is taken above six feet the rod is changed end for end, and the graduations read by the other vernier, the height to which the rod can be extended being a little over eleven feet.

This rod is very convenient on account of its lightness, but the parts are too frail to withstand the rough usage of this country, and American engineers generally prefer other rods which are heavier and more substantial.



NO. 503. BOSTON ROD. Price, \$14.00

TROY ROD

No. 504

The cut represents another form of the sliding leveling-rod, called the Troy rod. This is a self-reading rod up to six feet, or it can be read by a vernier on the rear piece to thousandths of a foot, as usual.

It has two targets as shown, both fastened to the front half of the rod, the lower one having its middle line just three-tenths of a foot above the end, and the other target exactly six feet above the lower.

There is a clamping piece with screw on the back of the rod, below the upper target, by which the two parts are clamped together when desired.

The face of the front piece is recessed like that of the Philadelphia rod, painted white, graduated to feet and hundredths, and figured as represented.

The side of the front half is graduated to feet and hundredths, read by a vernier on the top of the rear half to thousandths, and figured from the top downward, beginning with three-tenths, that being the height of the middle line of the lower target.

When a level of less than six feet is taken on the rod the observation is made by the lower target, and the reading is direct as given on the side; but when a greater height is taken the upper target is sighted upon, and six feet



No. 504. TROY ROD. Price, \$10.00.



added to the reading on the side, a reading up to twelve feet being thus readily obtained.

NEW YORK ROD

No. 505

This rod is made in two parts, the pieces sliding one from the other, the same end being always held on the ground and the graduations starting from that point.

The graduations are made to tenths and hundredths of a foot, the tenth figures being black, and the feet marked with a large red figure.

The front surface, on which the target moves, reads to six and one-half feet on the two-part rods. When a greater height is required, the horizontal line of the target is fixed at the highest graduation, and the upper half of the rod carrying the target is moved out of the lower, the reading being now obtained by a vernier on the graduated side, up to an elevation of twelve feet.

The target is round, made of brass with a raised rim to strengthen it and to protect the paint from defacement. It is arranged with an improved clamp, which can be so adjusted as to regulate the friction on the rod, allowing the target to be easily moved up and down or to be clamped by a slight turn of the binding-screw.

The face of the target is divided into quadrants by horizontal and vertical diameters, the

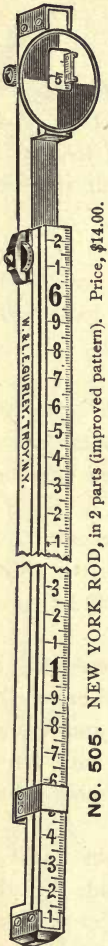



Price, \$18.00.

NO. 507. NEW YORK ROD, in 3 parts.



quadrants being painted alternately white and red, or sometimes white and black.

The opening in the face of the target is nearly two-tenths of a foot long, so that in any position a figure noting a tenth of a foot can be seen on the surface of the rod.

The right edge of the opening is chamfered, and graduated into ten equal spaces corresponding to nine hundredths on the rod. The graduations start from the horizontal line which separates the colors of the face.

The vernier, like that on the side of the rod, reads to thousandths of a foot. The rod is fitted with the improved clamp.

NEW YORK ROD

In three parts. No. 507

In this rod, as shown, a third piece is added, giving a rod of greater length, and at the same time making it more compact and portable. The graduations, verniers and readings are the same as those of the rod in two parts.

The three-part rod allows a reading of twelve and one-half feet, and when closed is five feet long.

MINING RODS

Nos. 502A and 509

Both the Philadelphia rod and the New York rod in two parts are made in lengths suitable for use in underground work, reading

when closed to three and three-tenths feet, and sliding to five feet when extended.

ARCHITECTS' ROD

Nos. 510 and 511

This is a very light and simple sliding rod in two equal parts, each seven-eighths of an inch square, and when closed the rod is about five feet six inches long.

As shown, the front half is graduated on two sides to feet, tenths and hundredths, reading by verniers on the target and side to thousandths of a foot.

The target is similar to those of the rods already described, and moves on the closed rod when levels of less than five and four-tenths feet are to be taken.

When a greater height is needed, the target is fixed at the highest graduation, the front half carried above the rear part and clamped by the clamp screw at any point desired, and the height up to ten feet read off by the vernier on the lower half.

This rod is adapted for use with any level, and is so light and efficient that it has been received with favor. It is, however, generally used with the Architects' and Drainage Levels. When it is designed for architects' use the graduations are in feet, inches and sixteenths, and no verniers are required.

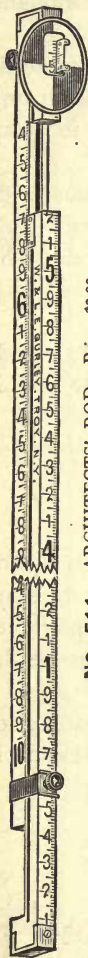

NO. 511. ARCHITECTS' ROD. Price, \$6 00.

MACHINISTS' ROD

No. 512

The Machinists' rod is in one piece with a cross-section about seven-eighths of an inch square and a length of six and one-half feet, and is graduated on one face to feet, inches and sixteenths. Attached to one end of the rod with a swivel is a large hook by which the rod may be hung from a shaft.

The target is painted red with broad white lines crossing the center, and is fitted with candle-holder. This rod is designed especially for use in leveling shafting in factories, and, used with the Architects' Level, will be found of great service.

TELEMETER OR STADIA ROD

No. 513

This rod is formed of two pieces of pine, each two and one-half inches in width and six feet long. The inner surfaces of the rod are recessed and painted white, with graduations in black to feet, tenths and hundredths, the feet figured in red and the tenths in black. The two pieces are connected by strong brass hinges and are folded in transportation. When in use they are opened, laid flat and held firmly in line by a strong clip on the back of the rod. The rod tapers

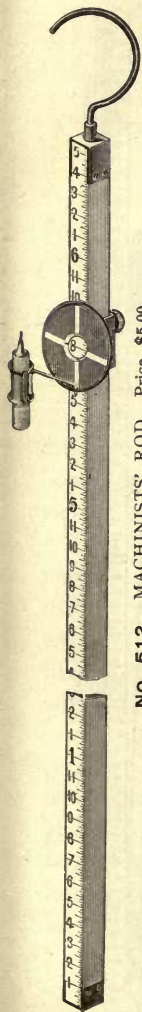

No. 512. MACHINISTS' ROD. Price, \$5.00.

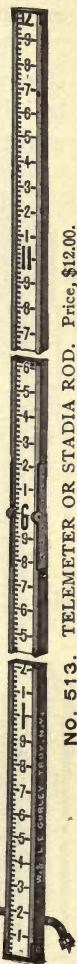

No. 513. TELEMETER OR STADIA ROD. Price, \$12.00.

toward the top from a thickness at the bottom of one and one-eighth inches.

This is a self-reading rod, and is often used in connection with the stadia to ascertain distances by simple observation, in the same manner as the Philadelphia rod.

TELESCOPIC ROD

No. 515

This rod is so made that the two smaller upper parts slide out of a larger and lower part which answers as a case. When closed, the rod is five feet long, and it extends to fourteen feet. It is graduated on a recessed face to feet, tenths and hundredths, the graduations being painted and figured like those of the Philadelphia and Telemeter rods.

CROSS-SECTION ROD

No. 516

This rod is made of well-seasoned pine, and is ten feet long and one and one-half inches square at the ends. It is about four inches thick at the middle, where there is an opening for the hand as shown. Both sides are graduated on a recessed white surface, the graduations being painted black like those of a leveling-rod, and figured from the same end of the rod. There is also an adjustable spirit-level at each end, one of which is shown in the cut.



No. 515. TELESCOPIC ROD. Price, \$22.00.



No. 516. CROSS-SECTION ROD. Price, \$10.00.

PLAIN LEVELING-ROD

No. 518A

A very good self-reading rod is made of seasoned white pine, recessed and graduated on one face like the Philadelphia rod. A rib at the back, extending through the length of the rod, gives great rigidity, while it does not materially increase the weight. This rod is commonly made ten and twelve feet long, but can be made longer if desired, at an additional cost of about fifty cents per foot. These rods are also made with a hinge joint at the middle. See page 284.

PLAIN LEVELING-ROD

In four parts, No. 524A

This is a simple form of self-reading rod in four parts, very light and compact, capable of extension to eleven and two-tenths feet, and reading to hundredths of a foot. This same form of rod is also made in two parts, extending to ten, twelve or fourteen feet. See Nos. 522A, B and C.



NO. 518A. PLAIN LEVELING-ROD. Price, \$6.00.



HINGE JOINT FOR PLAIN RODS.



NO. 524A. PLAIN LEVELING-ROD, in 4 parts. Price, \$10.00.

METRIC RODS

Besides the usual graduation of leveling-rods into feet and parts of a foot, we graduate them, when desired, into meters, decimeters and centimeters.

The scales on the targets and sides of the rods read the centimeters to millimeters on all except the telemeter, telescopic and plain rods, which have no targets and are read only to centimeters. The New York, Troy, Boston and Architects' metric rods are graduated, when desired, to read by vernier to one-tenth of a millimeter.

FLEXIBLE OR POCKET LEVELING-RODS

Nos. 525A to 528

A convenient form of self-reading rod, where only approximate results are essential, is the flexible or pocket leveling-rod, as shown on page 284 of the Price List.

This rod is made of specially prepared canvas, graduated on its painted surface to feet, tenths and hundredths, or to special design, and when not in use it can be rolled up and carried in a case or in the pocket. In use it is fastened to a board with thumb-tacks.

LEVELING-POLE

The leveling-pole, shown in No. 530, is a combination of a plain self-reading rod and a flag-pole. It is made with flat face, front and rear, and rounded sides. One face is graduated to feet and hundredths of a foot, while the other face and sides are graduated to feet only and are painted red and white alternately.



No.
530

The pole is made seven and nine feet long, the graduated faces reading to six and eight feet respectively, and when used as a rod is read as shown in the cut. See page 285.

WOOD AND IRON FLAGSTAFFS

We make three sizes of the common wood flag-staffs, or ranging-poles. They are octagonal in form, tapering from the bottom to the top, are six, eight and ten feet long, and have steel shoes. See cut, No. 534.

We also make a ranging-pole of an iron tube, eleven-sixteenths of an inch in diameter, hung in gimbals so that it can be readily set over a given point. See cut, No. 539. Similar iron poles are made without gimbals, six, eight and ten feet long.

These staffs are graduated to feet, and painted alternately red and white. When desired they are also graduated metrically, five spaces to each meter.

JOINTED RANGING-POLE

Nos. 537A to 538B

For use where compactness is a requisite, we make a ranging-pole having one or more protected screw-joints. This pole is about one inch in diameter, and is furnished, if desired, with a heavy canvas case to contain the several parts, and to protect them from injury in transportation. See page 285 of the Price List.



No. 534 No. 539

ROD LEVEL

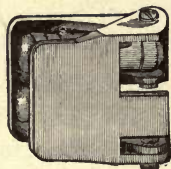
**NO. 545. ROD LEVEL**

Price, \$3.00.

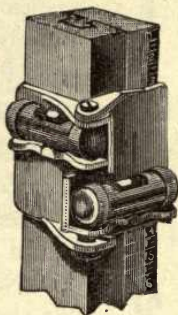

ROD LEVEL AS APPLIED TO A ROD

No. 545 represents a level for the accurate plumbing of leveling-rods and ranging-poles. The figures show it when folded for carrying, and also as attached to a rod.

It is held in place by the hand, or it may be secured by a string or rubber band slipped over hooks attached to each plate of the level. Its convenience and value have commended it to general favor.

CIRCULAR ROD LEVEL

We also make a rod level with circular level-vial, folding against the rod when not in use. This level is to be attached to the rod, and hence cannot be used where there is a target or clamp band to slide past it. It is very serviceable on self-reading and stadia rods. See No. 546 of the Price List.

For prices of leveling-rods, flagstaves, jointed ranging-poles and rod levels, see pages 283 to 286 of the Price List.

PLANE-TABLE

THE recognized utility of the Plane-Table for topographical and map drawing is bringing it into use in this country, and to meet the demand for instruments of moderate cost and real efficiency we have introduced several patterns.

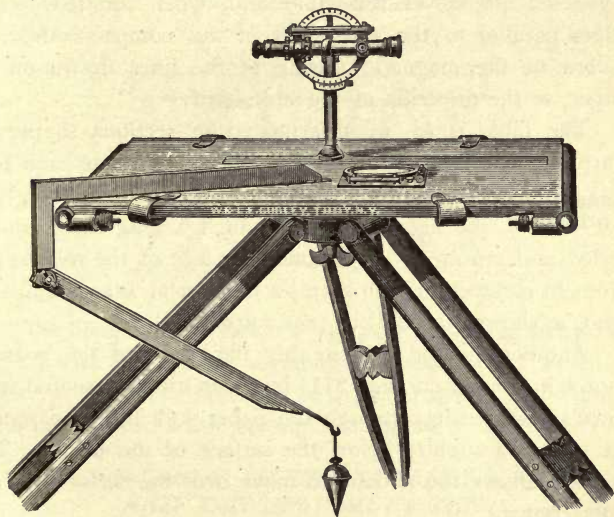

No.	No. 553	PRICE
553	Plane-Table, board 30 x 24 inches, mounted on large tripod, with leveling-socket and clamp, plumbing-arm, plummet and clamps for paper	\$45.00
	Combined Compass and levels	15.00
	Alidade, with telescope 9 inches long, power 20 diameters, with stadia, vertical circle to 1 minute, level on telescope and clamp and tangent, mounted on column as in engraving.	70.00
	Price as shown, total.....	<u>\$130.00</u>

The plane-table consists mainly of a drawing-board mounted upon a firm tripod, as shown in No. 553, having upon its upper surface a movable straight-edge or alidade, arranged either with sight vanes or a telescope, by which it may be directed to any point, a line being then drawn on the paper along the edge of the alidade.

A square brass plate, to which is attached a compass with two spirit-levels, is also shown, and serves both **COMPASS** to level the table and, when applied by the edges parallel to the zero lines of the compass circle, to determine the magnetic bearing of the lines drawn on the paper, or the direction of the table itself.

The table is of wood arranged in sections to prevent warping, and has an adjustable wooden roller at each end, **DRAWING-BOARD** by which the paper is brought down snugly to the board, or upon which a long sheet can be rolled and unrolled. Sometimes in place of the rollers, and often in connection with them, a number of brass clamps are used, as shown, to hold the paper firmly.

Another method of fastening the paper to the board is shown in the cut on page 211, in which are represented small brass screws passing through the paper and into brass sockets let into and slightly below the surface of the board. This method allows the alidade to move over the surface without interference.

The plumbing-arm, shown in the figure, has its end brought to a point, that it may be set at any given place **PLUMBING-ARM** upon the paper, the plummet hanging from the under arm determining the corresponding point on the ground. The lower arm moves upon a hinge, an index on the side showing when the ends of the two arms are plumb with each other as applied to the table.

The construction of the socket and tripod head is shown below, *a* representing the hemispherical concave metal cup fastened by six screws to the wooden top of the tripod, *b* the upper or convex part fitting into the cup and clamped to it by the clamping piece, *c*, and nut, *d*. A strong spiral spring in the hollow cylinder between *c* and *d* serves to hold the two spherical surfaces of the socket together, and allows the easy movement of one within the other in the leveling of the table.

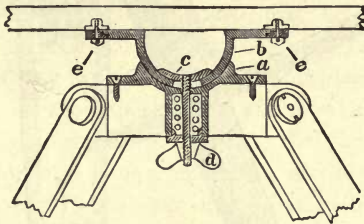

The flange of the socket *b* supports the table, and is connected with it by three segments of brass, two of which are shown at *e e*. The table can be oriented at will, and clamped by a milled-head screw passing through one of these segments.

PLANE-TABLE WITH LEVELING-SCREWS AND TANGENT MOVEMENT

The cut on page 208 shows a modification of the simple plane-table, there being added a tangent movement in azimuth and three screws for leveling.

The board appears as if cut away, to show in detail the socket and leveling-screws and tangent movement, by which a more delicate orienting may be obtained than by the method before described.

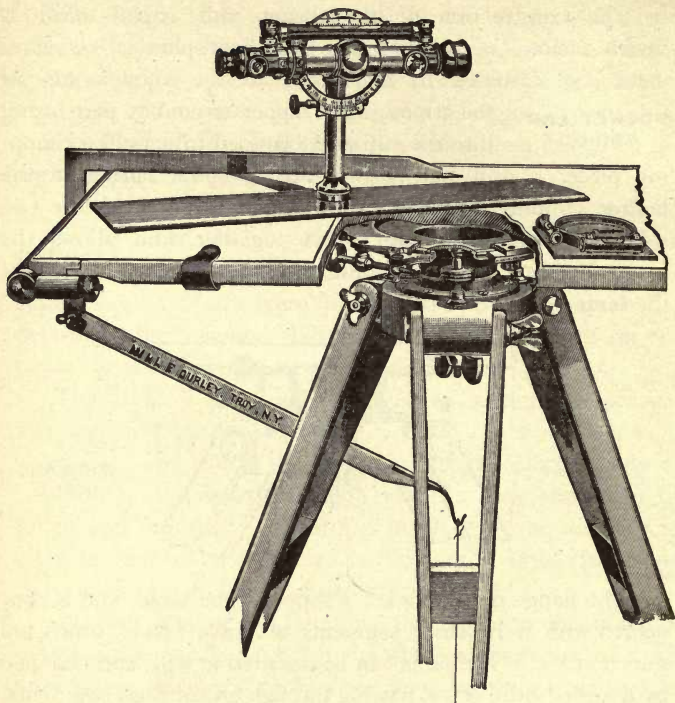

The Plane-Table outfit shown above is our No. 549, and costs as follows :

	PRICE
Plane-Table, board 30 x 24 inches, mounted on large tripod, with leveling-socket and clamp, and with plumbing-arm, plummet, and clamps for paper.....	\$45.00
Set of three leveling-screws.....	10.00
Clamp and tangent, for movement in azimuth.....	10.00
Combined Compass and levels, with square base.....	15.00
Alidade, with telescope 11 inches long, with stadia, 4½-inch vertical circle with vernier to 1 minute, level on telescope and clamp and tangent, on column, power of telescope 24 diameters.....	90.00
Total	\$170.00

TO USE THE PLANE-TABLE

The tripod is set up firmly, and the board with the upper half of the spherical socket attached is placed upon the lower half of the socket fastened to the tripod, the wing clamping-nut being screwed up until the table is secure upon the tripod. The board is moved by the pressure of the hand, or by the leveling-screws, until the level-bubbles upon the compass plate will remain in the middle upon any part of the surface. The wing-nut is then screwed up and the board made firm upon the tripod.

Any place on the drawing-board may be assumed as a starting point, its position over a given point on the ground being determined by the plumbing-arm and plummet. From the given point on the paper, sights can be taken to different corners of the field, and lines drawn on the paper along the edge of the alidade. Thus a miniature of the tract can be traced on the paper, the bearing of any line being ascertained by applying the side of the compass plate to the edge of the alidade placed on that line. The table can be oriented, either by the hand, on releasing the milled-head screw which clamps the flange, or by the tangent screw as before described.

The measurement of distances by the stadia wires of the telescope, and of vertical angles by the circle, is effected as already described in our account of the transit.

*JOHNSON IMPROVED PLANE-TABLE
MOVEMENT*

We illustrate on page 211 what is known as the Johnson Plane-Table movement, complete with large alidade, plumbing-arm and compass.

The board is shown as cut away, to give a better view of the tripod and movement. In the lower corner is shown the movement alone, with a portion cut away to show the construction. This movement has been largely used by the topographers of the U. S. Geological Survey.

As shown, this movement supplies an arrangement whereby the table can be easily made horizontal and then secured by the large wing-nut, A. To orient the board, the wing-nut, B, is loosened, leaving the hemispherical surface, bearing the board secured to the flange, free to turn, and it can be clamped by screwing up the same nut. This movement as modified in recent years supplies an extremely efficient and portable plane-table.

The movement with legs complete weighs about nine pounds. The legs are of straight-grained second-growth hickory, and the construction of the whole tripod is such as to secure strength and accuracy, and it is capable of standing rough usage without getting out of order.

Any of the alidades, as described on pages 212 to 214, can be used with the Johnson Plane-Table.

See pages 288 and 289 for a list of Johnson Plane-Table outfits, with prices.

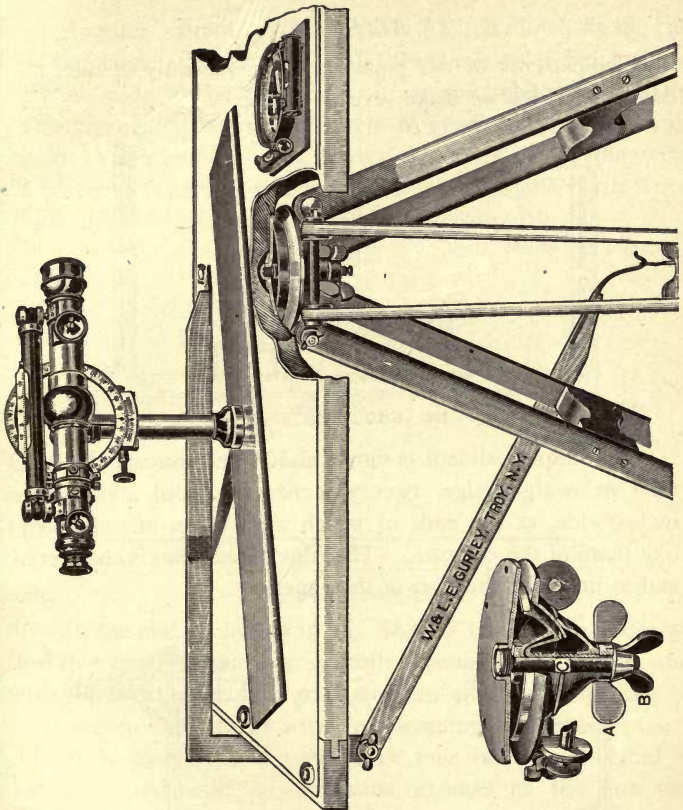

The Johnson Plane-Table outfit as shown above is our No. 576, and costs as follows :

	PRICE
Johnson Improved Plane-Table movement, mounted on large tripod.....	\$35.00
Plane-Table Drawing-Board, 31 x 24 inches, fitted, and with screw-sockets and clamps for paper	5.00
Plumbing-arm and plumbet	4.00
Combined Compass and levels with square base.....	15.00
Alidade, with telescope 11 inches long, with stadia, $4\frac{1}{2}$ -inch vertical circle with vernier to 1 minute, level on telescope and clamp and tangent, on column, power of telescope 24 diameters.....	90.00
Total	\$149.00

ALIDADES

The patterns of our plane-tables vary mainly in their alidades, of which we make several kinds.

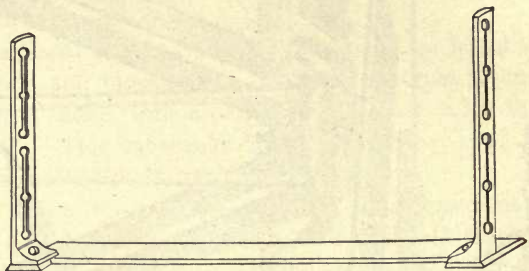

No. 580. Price, \$15.00.

The simplest alidade is shown above, and consists of a brass ruler or straight-edge, twenty inches long and about three inches wide, at the ends of which sight vanes are mounted, like those of the compass. The edge of the ruler is chamfered and in line with the slots of the vanes.

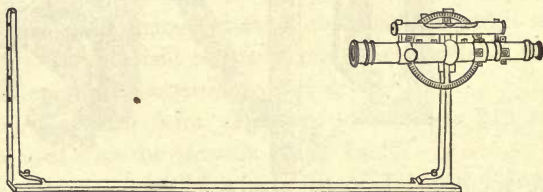

No. 581. Price, \$50.00.

The figure No. 581 shows the alidade to which is fitted the telescopic sight, having a level, clamp and tangent, and vertical circle reading to five minutes attached to the telescope, which has also stadia wires. The telescope is placed in line with the fiducial edge.

Another pattern of alidade, No. 582, is shown in the cut of the plane-table on page 205, the brass ruler being three inches wide. The column supports the telescope with its attachments. The vertical circle is graduated on silver and reads to one minute. The telescope is nine inches long with a power of twenty diameters, and is provided with stadia wires and adjusted like the telescope of the transit.

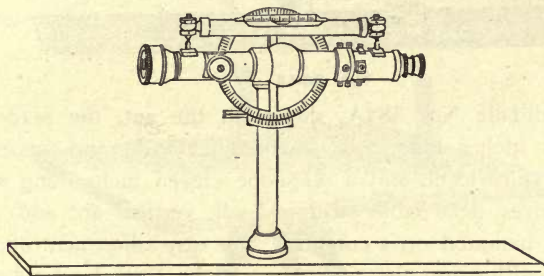

No. 583. Price, \$90.00.

In the alidade shown in No. 583 the telescope is the same as that used in our best transits, having level, clamp and tangent, vertical circle graduated on silver and reading to one minute, and stadia wires for measuring distances.

It is placed on a brass ruler four inches wide, and is adjusted and used in the same manner as the one just described.

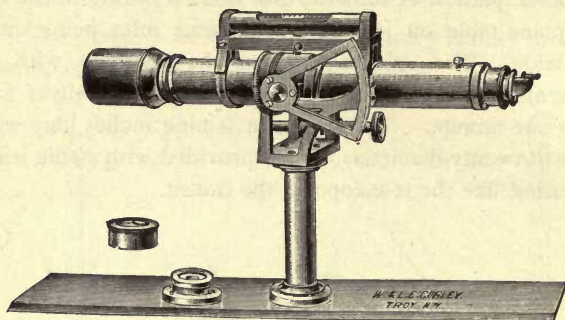

No. 584A

In alidade No. 584A, shown in the cut, the blade is eighteen inches long and three inches wide, and carries a circular spirit-level, and a telescope eleven inches long with stadia wires, detachable striding-level, vertical arc and axis tangent, mounted on a column. For easy adjustment of the line of collimation the telescope can be turned on its axis through 180° . The vertical arc reads by vernier to one minute, and as the zero is at one end all the angles read are positive.

The telescope is made either inverting or erecting, as desired, and is fitted with a diagonal prism with darkener, as shown. A rectangular box compass, with four-inch needle, and attached to the alidade, is also furnished when desired.

No. 584A	Price, as shown, with inverting eye-piece	\$118.00
No. 584B	Price, as shown, but with erecting eye-piece	118.00
	Price of Box Compass, as above, \$10.00.	

Beaman Stadia Arc, No. 149, can be fitted to this Alidade, at an extra cost of \$15.00.

TRAVERSE PLANE-TABLE

The cut, No. 586, represents a simple form of plane-table and alidade, first made by us for the U. S. Geological Survey, and in its present improved form used extensively for traverse work. The board is fifteen inches square, and has on its under side a strong brass flange with spring, in which the plunger clamp of the tripod head engages, allowing the board to be clamped or oriented as desired. Small clamp screws with sockets for holding the paper are often placed at the corners of the board.

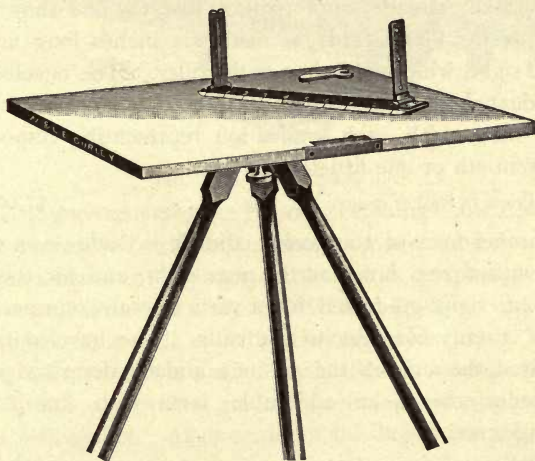

No. 586

Price as shown, \$30.00; if the tripod has extension legs, add extra \$5.00.

The alidade consists of a brass ruler ten inches long, graduated on the beveled edge to a scale of forty parts to the inch, and having at each end hinged sights which fold close to the surface of the ruler. The alidade is furnished with a leather

pouch. Inserted in one edge of the board is a small box compass with needle about four inches long.

The tripod legs are attached to a head which has a clamping-screw passing through its center, compressing a concealed spring and holding the board to the tripod head when oriented to position.

The whole, while not capable of as accurate work as the larger plane-tables, constitutes a light and portable instrument for topography.

POCKET ALIDADES

A pocket alidade, of a pattern like the one shown with the Traverse Plane-Table, is made six inches long and has hinged sights which fold close to the ruler. The beveled edge is graduated to scale of one forty-five-thousandth and one ninety-thousandth, each graduation representing respectively one-twentieth or one-fiftieth of a mile.

Price, in leather pouch.....\$7.50

Another form of the pocket alidade is made seven inches long, with a peep hole for the near sight, and for the other a folding sight graduated for a vertical scale representing a rise of twenty-five feet to the mile. The beveled edge is graduated the same as the six-inch alidade described above. The ruler carries an adjustable level with knurled-head leveling-screw.

Price, in leather pouch.....\$12.00

See page 289 of the Price List.

BATSON SKETCHING-CASE

PATENTED

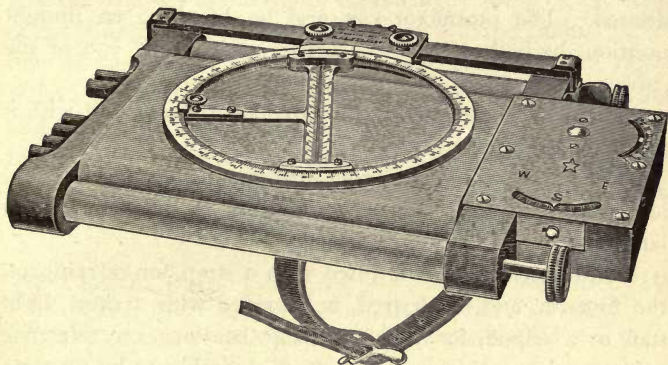

No. 595. Price, \$30.00.

THE engraving shows the Batson Sketching-Case, designed for the use of civil and military engineers and surveyors in reconnoissance and topographical surveys. It was given an extensive and successful trial, in 1898 and 1899, in Cuba and the Philippines, as well as in the United States.

This instrument is a small drawing-board, having upon its upper surface a movable graduated circle, carrying a small alidade with scales. At one end of the board are a compass and a clinometer.

The drawing-board is of wood and is provided with rollers which carry the paper for recording observations. Friction brakes hold the rollers, so that the paper is held down snugly to the board and prevented from uncoiling. Six holes at the end of the board opposite the compass afford receptacles for the pencils used in topographical sketching.

The protractor is held in position by a carrier which slides upon a bar attached to the wooden end-pieces, as shown. The construction of the carrier allows the protractor to be turned, or to be clamped by means of two set-screws, if desired. The protractor can also be lifted to an upright position, by pulling back the spring catch at the end of the carrier bar.

The alidade turns within the graduated circle, and with it forms the protractor.

The paper for use with this instrument is six inches wide, and from thirty to forty inches is found to be a convenient length.

The sketching-case is fitted with a strap for carrying on the forearm, and, if desired, is provided with a short, light staff or a tripod, for use in taking bearings on reference points and on objects which it is desirable to locate more accurately than is possible when holding the instrument in the hand.

A sole-leather case, having a pocket for the instrument and another for sketches and extra paper, and fitted with lock and shoulder strap, is provided with each instrument.

TO MOUNT THE PAPER

Raise the protractor to a vertical position. Holding the board with compass to the right, insert one end of the paper in the slit of the far roller and turn the roller toward the board until only seven or eight inches of the paper are left free, then insert the free end in the slit of the near roller and turn the roller toward the board until the paper is taut. Release the protractor and turn it down on the board.

TO SET THE INSTRUMENT

Release the needle. Face in the general direction of the route to be mapped and hold the instrument in the left hand with the compass to the right; or, having it set up on the staff, orient it until the long way of the paper is in the general direction of the route to be mapped, and the compass to the right. Hold steadily and read the bearing. Unclamp the protractor and turn it until the index on the upper plate of the carrier indicates the same reading on the protractor that is shown by the needle. The instrument is now set, and, if the ruler be turned to zero, it will lie in the magnetic meridian.

*TO PLACE THE CENTER OF THE PROTRACTOR
AND THE ZERO OF THE SCALES OVER
ANY POINT ON THE PAPER*

Move the paper by turning one of the rollers until the given point is opposite the center of the protractor. Unclamp the carrier of the protractor and slide it along the bar until the center of the protractor is over the point.

SCALES

The alidade carries two scales. The one on the right of the slit, when the clamping-arm is to the right, is graduated six inches to one mile, and the one on the left eight inches to one mile, each reading to twelve and one-half yards. Should it be desired to use a scale of three inches to one mile, or four inches to one mile, use the six-inch or eight-inch scale respectively, giving the smallest reading a value of twenty-five yards. In the same way a scale of one and one-half inches to one mile, or two inches to one mile, may be obtained, the smallest reading being fifty yards. If the distance is measured by counting paces, find, by pacing over a measured distance, the

number of steps or alternate steps taken in one hundred yards ; then, for each time this number of steps is counted, score one hundred yards. The total score will then be in yards, and is marked off on the scale of yards. This method will be found to cause no confusion. The soldier is trained to estimate distances in yards, and, as much estimating of distances is required in topographical work, a greater degree of accuracy can be obtained if only a scale of yards is used than if a scale of steps is used when the distance is paced, and a scale of yards when the distances are estimated.

The latter method is also open to the objection that two scales must be prepared before beginning the work. Few non-commissioned officers and privates understand scales sufficiently to construct one, although but little explanation is necessary to enable them to use one already constructed.

For keeping tally a tally register is most convenient, but any small pasteboard counter will answer.

TO USE THE SKETCHING-CASE

Set the instrument as explained. Select a point on the paper for the initial station. This point should ordinarily be about midway between the edges of the paper ; **AS A PLANE-TABLE** but when it is known that the route to be traveled deviates considerably to one side or the other from the general direction, then the point should be selected on the opposite side of the paper. The instrument should always be so set and the point representing the initial station so selected, that as much of the map as possible may be sketched without running off the paper.

Having selected the point representing the first station, center the protractor over this point. Holding the instrument in the left hand, or having it mounted on the staff,

orient it until the reading of the needle corresponds with the reading of the protractor circle. Holding it steady in this position, turn the alidade upon all objects it is desired to plot on the map, and draw light lines in the slit from the station point toward them. These objects should include the next station to be occupied. After having taken the slopes in the vicinity and sketched in the detail, the ruler is clamped in the direction of the next station.

With the protractor set as previously explained, orient the instrument until the right-hand edge of the board is in line with the object to be plotted upon the map, and read the compass. Turn the ruler to the corresponding reading on the protractor circle.

Bearings taken with the box or prismatic compass may be plotted upon the map in the same manner.

PRICES

Batson Sketching-Case, as shown, with leather case	\$30.00
Wooden Staff, about two feet long, with steel-pointed shoe.....	1.00
Plain Tripod, about 3½ feet long	3.50

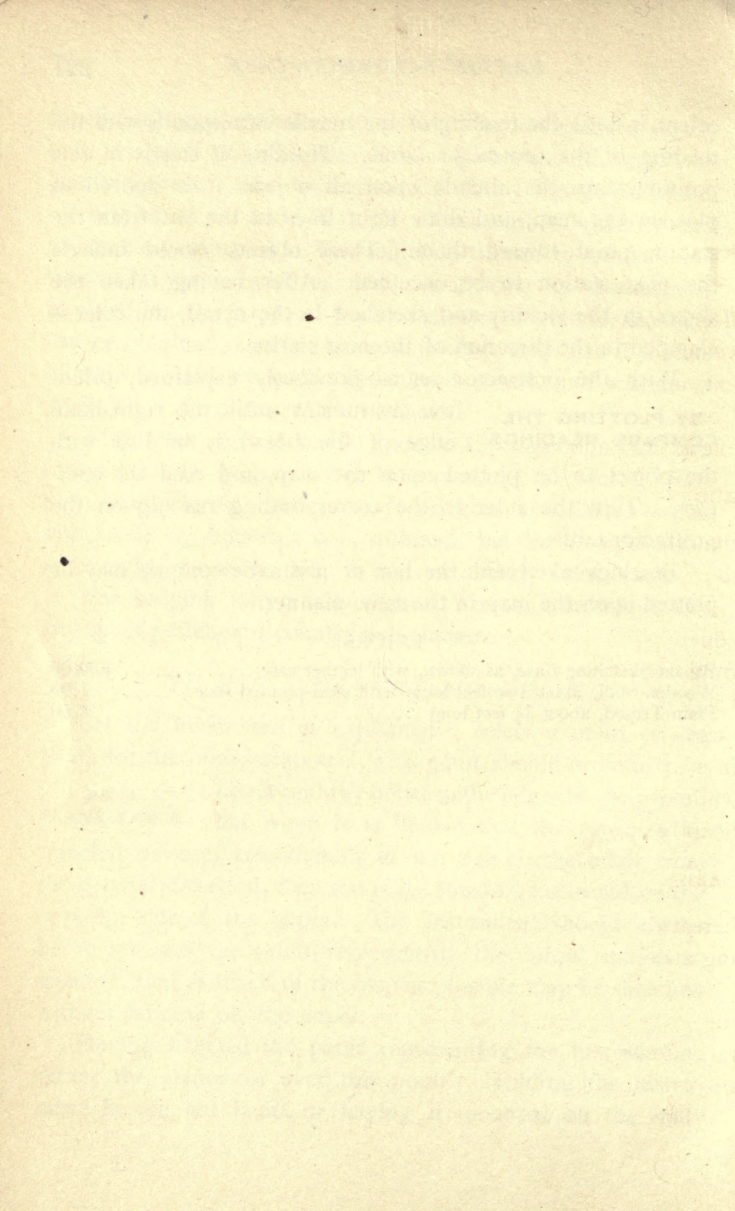

CURRENT METER

THE Price Current Meter, shown on page 224, was devised by W. G. Price, then a U. S. Assistant Engineer, after an experience of six years in measuring the velocity of water in the Ohio and Mississippi rivers by different methods. The instrument is used by the U. S. Engineer Corps, the U. S. Coast and Geodetic Survey, and by hydraulic engineers in different parts of the country.

BUCKET WHEEL The wheel of this meter carries five conical buckets, as shown, so arranged that the force of the slightest current will cause the wheel to revolve.

The ends of the axis of the wheel revolve in bearings contained in air chambers of metal, which afford protection from the water and any gritty matter it may contain. The friction is thus reduced to a minimum and made a constant quantity. The form of the wheel and buckets is such as to insure great strength and thus resist injury from driftwood, while at the same time they are not liable to obstruction from floating leaves and grass.

AXIS The upper end of the axis of the wheel extends above its bearing, entering an air-tight metal box hereafter named, and is cut down for a short distance, forming an eccentric.

A light spring, so arranged that it comes in contact with the eccentric, bears upon this divided part of the axis, and successively makes and breaks the electric current as the wheel revolves.

The spring and divided axis form the contact-breaker, and

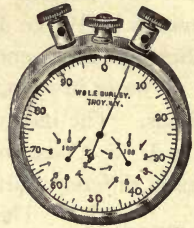

No. 609
ELECTRIC REGISTER
 Price, \$50.00.

No. 600
 Price, \$80.

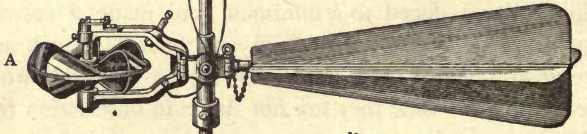

LEAD WEIGHT
AND ROD
 Price, \$15.00.

No. 606 **B**

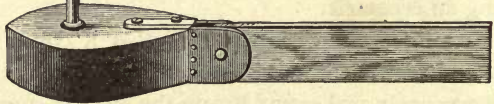

W & L GURLEY.

are both contained in the metal air-tight box which is shown in the cut.

A hollow cylinder of bronze, called the trunnion, fitting easily upon the rod, supports the frame of the meter by a pivot on each side. Thus by the rod and pivots the meter is free to move both horizontally and vertically, and so adjust itself to the direction of the current.

The frame of the meter is of bronze, and is very solid and strong. The rudder has four light metal wings or vanes, secured to a central rod, and is made to balance the weight of the wheel and give direction to it, and thus keep the wheel in both directions in line with the current. The meter frame has a hinged side secured by a spring key, allowing the meter and trunnion, which is itself in two parts, to be detached from the rod when desired. In the older form the trunnion was left on the rod. The connecting wires are passed upward through the trunnion of the meter, and so have no tendency to pull the meter out of the line of the current.

The rod is of brass, three-quarters of an inch in diameter and two feet long, its upper end having an eye of brass screwed firmly on and pinned, and its lower end screwed into a brass socket in the lead weight, B, and secured thereto by a jam-nut. A sliding ring of metal with set-screw, as shown, allows the meter to be raised to any point on the rod.

The weight, No. 606, is of lead and weighs about sixty pounds. It has a rudder of wood, as shown, secured to the weight by brass cheek pieces, which are also securely fastened to the weight by sockets cast in the lead. The rudder can be set at an angle with the weight, or turned up parallel with the rod for convenience in transportation.

The weight, B, is only necessary where the meter is used in deep water and harbor surveying, where the currents are very strong. In shallower water the meter is suspended upon a brass rod. These rods are each four feet long, and can be screwed together when a long length is needed. They are graduated to feet and tenths.

SIZE OF THE METER

This meter has a wheel six inches in diameter, and the total length, including the rudder vane, is about twenty-four and one-half inches. It is adapted for deep water and harbor surveying, and also for use in smaller rivers and streams, and is used either with or without the weight.

RATING THE METER

Before using the meter it is necessary to obtain its rating, which is the number of revolutions of its wheel made in passing over a measured distance, at different velocities. The meter should be rated in still water which is not less than five feet deep, and to secure a good rating there should be but little wind.

It should be attached to the bow of a skiff, as shown in the cut, and immersed not less than two feet. The boat should have no rudder. The observer should stake out two parallel range lines on shore, about two hundred feet apart and at right angles with the course the boat is to take.

Attach a quarter-inch cotton cord about three hundred feet long to the bow of the boat, and pass it around a pulley which is placed in line with the course. If there is a bend in the shore the pulley may not be necessary.

It will require three or four men to pull the boat fast enough for the high velocities, and there must be a man with oars in the boat with the observer, to prevent its running into the shore.

Haul the boat over the measured base at very slow, very fast, and medium velocities, which should be as nearly uniform as possible during each passage.

Before each trial note if the meter is free to point in the direction of the current, as in backing over the course the connecting wires are liable to become twisted so as to pull the meter out of line.

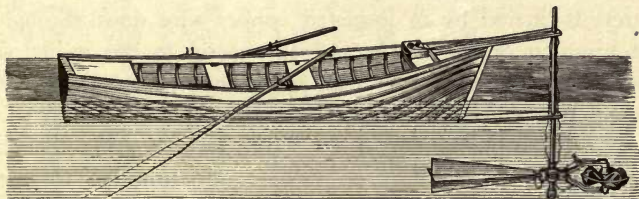

Fasten a vertical rod on the boat near the seat of the observer, to enable him to sight at the range stakes as he passes them. Start the time-recorder, see No. 619 of the Price List, and electric register on the first range line, and stop them on the second. Note accurately the time as given by the time recorder, and the number of revolutions of the wheel as indicated by the register.

The rating of a meter, which is the value in feet per second of one revolution of the wheel, will not change as long as the wheel turns freely and has not been seriously injured.

The velocity of a current of water can readily be computed from the Reduction Table furnished with each instrument, which is also given on page 229, the number of revolutions of the wheel per second having been already ascertained by observation, and recorded by the register.

Should the observer require greater accuracy, it is advisable that the individual rating of each meter be obtained. If

desired, we will rate the meter and furnish a reduction table, at a cost of about thirteen dollars.

ELECTRIC REGISTER

The number of revolutions of the meter wheel is recorded by an electric register, shown in No. 609, actuated by a battery of three cells.

The electric current proceeding from one pole of the battery is carried by an insulated copper wire down through the trunnion of the meter, and thence up to the insulated binding-post on the upper arm, as shown in the cut; thence through the contact breaker, the axis of the wheel and the lower arm, to the binding-screw shown on that arm; thence by a second copper wire up through the trunnion to one binding-screw of the register; thence through the register to the other binding-post; and thence, finally, by another wire to the other pole of the battery.

The electric register is enclosed in a brass case, showing three dials under a glass face, and has an electro-magnet which, when the circuit is made, moves a lever at the end of which is a pawl carrying forward a ratchet wheel one tooth at every contact of the current. The large dial is graduated into one hundred spaces and the two small dials into ten spaces each, all reading from left to right. The large dial counts each revolution up to one hundred, the small dial on the right counts one thousand revolutions by each hundred, and the small dial on the left counts ten thousand revolutions by each thousand, all indicated by the figuring.

We furnish a wet-cell battery to operate the electric register. The battery is composed of three cells in a wooden case, with lock and strap. See No. 612 of the Price List.

BATTERY

REDUCTION TABLE FOR USE WITH
ELECTRIC CURRENT METER, PATTERN No. 600

This table is a mean of the ratings of several different Meters and
will give correct values within one per cent. for any
Meter of its pattern when in good order.

REV. PER SEC.	VELOC. FEET PER SEC.	REV. PER SEC.	VELOC. FEET PER SEC.	REV. PER SEC.	VELOC. FEET PER SEC.	REV. PER SEC.	VELOC. FEET PER SEC.
0.00	0.16	1.00	3.33	2.00	6.35	3.00	9.24
.05	.31	1.05	3.48	2.05	6.50	3.05	9.38
.10	.46	1.10	3.63	2.10	6.65	3.10	9.52
.15	.62	1.15	3.78	2.15	6.79	3.15	9.66
.20	.79	1.20	3.94	2.20	6.94	3.20	9.79
.25	.95	1.25	4.10	2.25	7.08	3.25	9.93
.30	1.11	1.30	4.25	2.30	7.23	3.30	10.07
.35	1.26	1.35	4.40	2.35	7.37	3.35	10.21
.40	1.42	1.40	4.55	2.40	7.52	3.40	10.35
.45	1.58	1.45	4.70	2.45	7.67	3.45	10.49
.50	1.75	1.50	4.86	2.50	7.82	3.50	10.63
.55	1.91	1.55	5.01	2.55	7.96	3.55	10.77
.60	2.07	1.60	5.16	2.60	8.10	3.60	10.91
.65	2.23	1.65	5.31	2.65	8.24	3.65	11.05
.70	2.38	1.70	5.46	2.70	8.39	3.70	11.19
.75	2.53	1.75	5.61	2.75	8.53	3.75	11.33
.80	2.69	1.80	5.75	2.80	8.67	3.80	11.47
.85	2.85	1.85	5.90	2.85	8.81	3.85	11.61
.90	3.01	1.90	6.05	2.90	8.95	3.90	11.74
.95	3.17	1.95	6.20	2.95	9.10	3.95	11.88
						4.00	12.02

REDUCTION TABLE

To be used in reducing observed velocities to the mean vertical
velocity. The mean velocity is about ninety-six
per cent. of the mid-depth velocity.

DEPTH	PER CENT.	DEPTH	PER CENT.	DEPTH	PER CENT.
$\frac{1}{10}$	0.952	$\frac{4}{10}$	0.953	$\frac{7}{10}$	0.984
$\frac{2}{10}$	0.951	$\frac{5}{10}$	0.960	$\frac{8}{10}$	1.020
$\frac{3}{10}$	0.948	$\frac{6}{10}$	0.965	$\frac{9}{10}$	1.140

MULTIPLY THE MEASURED VELOCITY BY THE PERCENTAGE.

PRICE ACOUSTIC CURRENT METER

PATENTED

This meter was devised by W. G. Price, and has many points of excellence. It is very compact, light, and portable, and is especially designed for use in irrigation ditches or in streams where there is little depth of water. The cut shows the external appearance of the meter, with the brass tubes

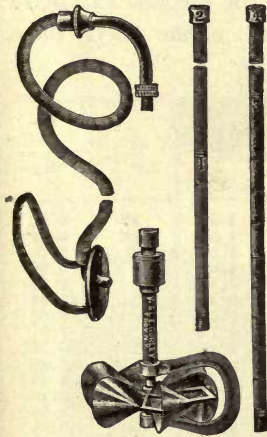

NO. 616

Price, \$50.00.

by which it is held while in use. The revolutions of the wheel are indicated by a hammer striking against a diaphragm, one blow for every ten revolutions, and the recording mechanism is enclosed in the stem of the meter and thoroughly protected from injury. The sound of the recording stroke is transmitted through the tubing suspending the meter, and is conveyed to the ear of the operator by the rubber ear-tube. In use, the operator fixes the ear-tube in position by a rubber band passing around his head, and thus both hands are left free for the manipulation of the meter.

Results obtained may be readily reduced by the use of the Reduction Table supplied with the meter, and also given on page 232.

Each meter is packed in a wooden box with lock and strap, and is provided with two lengths of nickel-plated brass tubing, graduated to feet and tenths up to four feet, and with four feet of rubber tubing with all necessary connections. Extra graduated brass tubing, in lengths of two feet, can be furnished at a cost of \$2.50 per length.

REDUCTION TABLE FOR USE WITH
PRICE PATENT ACOUSTIC CURRENT METER

PATTERN No. 616

This table is a mean of the ratings of fourteen meters, and will probably give correct values within one per cent. for any meter of its pattern when in good order.

The time column is the number of seconds that have elapsed during one hundred revolutions of the wheel, there being ten revolutions to each rap.

TIME	VELOCITY	TIME	VELOCITY	TIME	VELOCITY	TIME	VELOCITY
1000	0.27	111	2.11	59	3.96	37	6.28
666	.39	105	2.22	57	4.08	36	6.51
500	.50	100	2.34	56	4.20	34	6.74
400	.61	95	2.46	54	4.31	33	6.98
333	.72	91	2.57	53	4.43	32	7.21
286	.83	87	2.69	51	4.54	31	7.44
250	.95	83	2.80	50	4.66	30	7.67
222	1.07	80	2.92	49	4.78	29	7.91
200	1.18	77	3.03	48	4.90	28	8.25
182	1.30	74	3.15	46	5.01	27	8.48
167	1.42	71	3.26	45	5.12	26	8.83
154	1.53	69	3.38	44	5.24	25	9.29
143	1.65	67	3.50	43	5.35	24	9.64
133	1.77	65	3.61	42	5.58	23	10.10
125	1.88	62	3.73	40	5.82	22	10.56
118	1.99	61	3.85	38	6.05	21	11.02

*ELECTRIC CURRENT METER, WITH VANE AND
LEAD WEIGHT*

FOR USE IN SMALL STREAMS

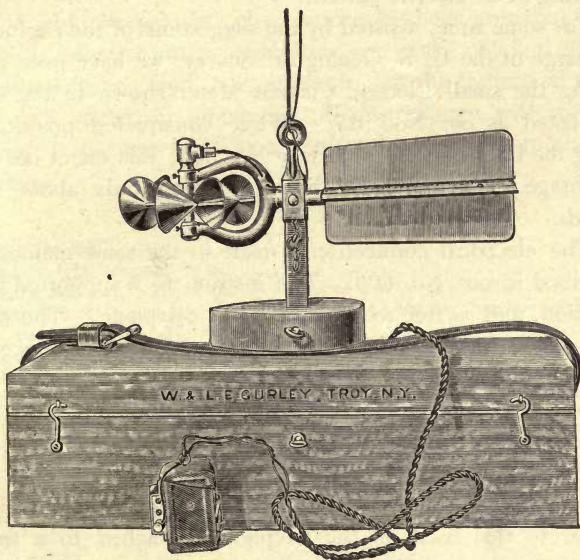
**NO. 617**

Price, as shown, \$60.00.

The importance of correct hydraulic measurements has brought the current meter into general use, and while our No. 600 has long been regarded as a standard instrument for observations on large streams, there has been in recent years a demand for a light and serviceable meter for use in small streams and irrigation or drainage ditches.

In response to this demand the Acoustic Current Meter,

indicating by sound the revolutions of the wheel, was introduced, and has met with a favorable reception by hydraulic engineers. Many observers, however, prefer that the revolutions of the wheel should be indicated by the making and breaking of an electric current.

For some time, assisted by the suggestions of the engineers in charge of the U. S. Geological Survey, we have been perfecting the small Electric Current Meter shown in the cut, and listed as our No. 617. While constructed practically along the lines of Current Meter No. 600, this meter has the advantage of extreme lightness, weighing only about two pounds.

The electrical connection is made in the same manner as described in our No. 600. The instrument is supported in a trunnion, and is free to swing in a vertical plane. The vane is so made that it may be taken apart for convenience in transportation.

In use, the meter is suspended by a cable containing the wires for electrical connection, and is held steady by a lead weight, as shown in the cut.

The electric sounder as now made consists of an ear-piece similar to that used on the telephone, attached to a small leather case containing the battery with either a bi-sulphate of mercury or a dry cell.

Every revolution of the wheel is indicated by the ear-piece, the observer being required to count the number of revolutions in a certain period of time.

A strap attached to the battery case permits the sounder to be secured to the shoulder of the observer in such a way that he may note the revolution of the wheel and have his hands free to manipulate the meter.

The weight is now made in torpedo form and provided

with vanes, so that it will readily take the direction of the current.

The meter is packed in a strong wooden box, large enough to contain the meter, lead weight, sounder, wire, and other apparatus for the observer.

A table for reducing observations has been prepared which will give correct values within one per cent. Should greater accuracy be required, it is advisable that the individual rating of each meter be obtained. If desired, we will rate the meter, furnishing table at a cost of from twelve to thirteen dollars.

PRICES

Meter No. 617.....	\$50.00
Lead Weight, torpedo form.....	3.50
Electric Sounder, with telephone ear-piece and twenty feet of cable.	10.00
Meter No. 617, complete with lead weight, electric sounder and twenty feet of cable	63.50
Extra length of cable, 5 cents per foot.	
Special Commutator box, applicable to Current Meter No. 617, so arranged that either every revolution or every fifth revolution of the bucket wheel may be indicated, making it possible to register very high velocities.....	15.00

REDUCTION TABLE FOR USE WITH
ELECTRIC CURRENT METERS, Nos. 617 AND 618

This table is a mean of the ratings of ten different Meters, and
will probably give correct values within one per cent.
for any Meter of its pattern in good order.

REV. PER SEC.	VELOC. FEET PER SEC.	REV. PER SEC.	VELOC. FEET PER SEC.	REV. PER SEC.	VELOC. FEET PER SEC.	REV. PER SEC.	VELOC. FEET PER SEC.
.00	.07	1.00	2.38	2.00	4.71	3.00	7.03
.05	.18	1.05	2.50	2.05	4.82	3.05	7.14
.10	.29	1.10	2.62	2.10	4.99	3.10	7.26
.15	.40	1.15	2.73	2.15	5.05	3.15	7.38
.20	.52	1.20	2.85	2.20	5.17	3.20	7.50
.25	.64	1.25	2.96	2.25	5.29	3.25	7.61
.30	.76	1.30	3.07	2.30	5.41	3.30	7.73
.35	.87	1.35	3.19	2.35	5.52	3.35	7.84
.40	.99	1.40	3.31	2.40	5.64	3.40	7.96
.45	1.10	1.45	3.43	2.45	5.75	3.45	8.08
.50	1.22	1.50	3.55	2.50	5.87	3.50	8.20
.55	1.34	1.55	3.66	2.55	5.98	3.55	8.31
.60	1.46	1.60	3.78	2.60	6.10	3.60	8.43
.65	1.57	1.65	3.90	2.65	6.22	3.65	8.54
.70	1.69	1.70	4.01	2.70	6.34	3.70	8.66
.75	1.80	1.75	4.12	2.75	6.45	3.75	8.77
.80	1.92	1.80	4.24	2.80	6.57	3.80	8.89
.85	2.03	1.85	4.35	2.85	6.68	3.85	9.00
.90	2.15	1.90	4.47	2.90	6.80	3.90	9.12
.95	2.26	1.95	4.59	2.95	6.91	3.95	9.24
						4.00	9.36

*ELECTRIC CURRENT METER, OMITTING VANE
AND LEAD WEIGHT
FOR USE IN SHALLOW STREAMS*

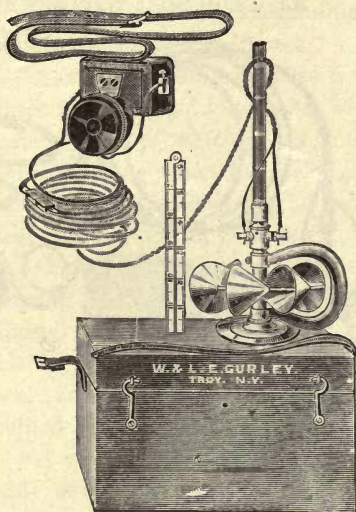

No. 618

Price, complete, \$63.50

A modification of the Electric Current Meter, No. 617, is shown in No. 618. The vane, lead weight, and suspending cable are omitted. The meter is mounted on a base, as shown, and is provided with two lengths of nickel-plated brass tubing, graduated to feet and tenths up to four feet, and is easily held in position with the base resting on the bed of the stream. The electric sounder, with twenty feet of cable, and connections are the same as those used with the meter No. 617. The instrument and its smaller accessories are packed in a wooden box with lock and strap.

The Reduction Table on page 236 is intended for use with this meter.

*ELECTRIC CURRENT METER, WITH VANE AND
TORPEDO LEAD WEIGHT*

FOR USE IN SMALL STREAMS

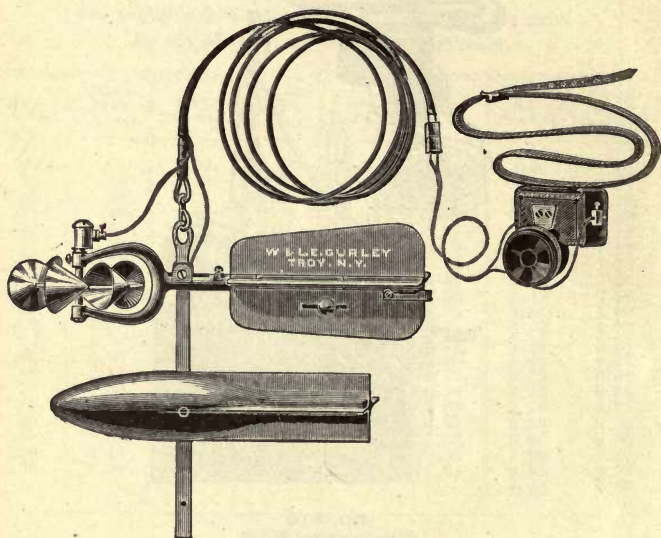

No. 621

Price, complete, as shown, \$63.50

We illustrate above a new model of current meter similar in form to No. 617, but modified in some particulars, the most important of which is that only every fifth revolution of the wheel is indicated, thus facilitating the use of the meter for high velocities, when it would be difficult to note each revolution of the wheel.

PRICE

Electric Current Meter No. 621, with vane, torpedo weight, electric sounder with telephone ear-piece and twenty feet of cable. Meter arranged to indicate only every fifth revolution of the wheel.....\$63.50

BOYDEN HOOK-GAUGE

This instrument, so called from the name of its inventor, is used in determining the depth of water flowing over weirs, etc.

As shown in the cut, it has a frame of wood, three feet long and four inches wide, in a rectangular groove of which is made to slide another piece carrying a metallic scale, graduated in feet and hundredths, and figured from zero to two feet and two-tenths, as shown.

Connected with the scale is a brass screw passing through a socket, fastened to another shorter sliding piece, shown in cut, which can be clamped at any point on the frame, and the scale with hook moved in either direction by the milled-head nut.

A vernier is also attached to the frame, movable under the screw heads which secure it, in order to adjust its zero to correspond with the point of the hook, as will be described hereafter. The vernier reads the scale to thousandths of a foot.

The hook is of brass and has a sharp point, which, when raised to the surface of the water at rest, indicates its precise level.

TO USE THE HOOK-GAUGE

The hook-gauge is used in a box attached to a flume at any convenient point near the weir, the water from the flume being conveyed to the box by rubber or lead pipes, thus indicating the precise level of the water in the flume, the surface of the water in the box being at rest.



No. 629

Price, \$25.00.

When the depth of the water passing over a weir is required, the exact level of the crest of the weir should be taken by a leveling-instrument and rod, and marked by a line drawn in the still-water box above the surface of the water. The scale of the gauge being previously set at zero with the vernier, the frame is fastened to the box above the water in such a position that the point of the hook is at the same level as the crest of the weir, the precise point being secured by the adjusting-screw of the scale. See that the zeros of the scale and vernier are in line, and if not, move the vernier under the screw heads until the zeros correspond, and set the vernier fast. The point of the hook will, of course, be under water, and level with the crest of the weir.

The depth of water flowing over the weir is the distance between the point of the hook in the position named and the exact surface of the water. To ascertain this, the hook is raised by turning the milled-head nut until the point of the hook, appearing a little above the surface, causes a distortion in the reflection of the light from the surface of the water. A slight movement of the hook in the opposite direction will cause the distortion to disappear, and will indicate the surface with precision. The reading of the scale will then give the depth of water passing over the weir, in thousandths of a foot.

It will be understood from the cut that the longer movements of the scale are made by moving the clamping piece over the frame, the finer adjustments being effected by the milled nut.

We are also prepared to make to order, from designs furnished, water registers, tide gauges, and all similar instruments.

TELESCOPIC HAND LEVELS

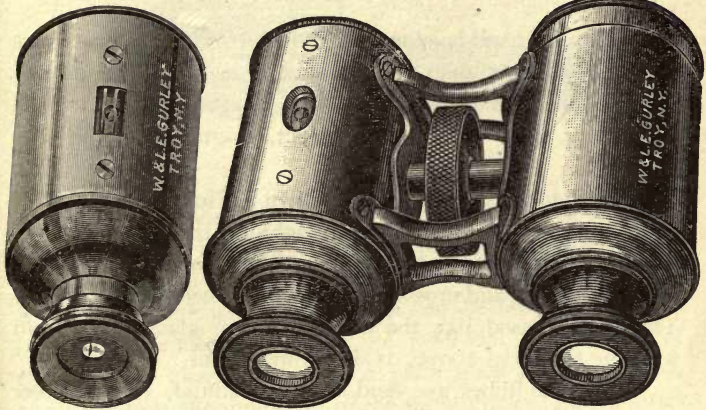

NO. 640

Price, \$12.00.

NO. 641

Price, \$15.00.

The figures represent instruments devised by us as an improvement upon the ordinary hand levels, calculated to increase their usefulness in the work of the engineer.

The Monocular Hand Level, shown in No. 640, consists of a tube to which are fitted the lenses of a single opera glass, and which also contains a reflecting prism, a cross-wire, and a level-vial, the latter being seen in the open part of the tube.

The eye lens, as indicated in the cut, is composed of two separate pieces, the larger one being the usual concave eye lens of the opera glass, and the smaller a segment of a plano-convex lens having its focus on a cross-wire under the level-vial and above the reflecting prism.

The observer holds the tube horizontal with the level-opening uppermost, and observes the object to which the

instrument is directed, and the position of the level-bubble with reference to the cross-wire on the under side of the level-vial.

When the hand level is held truly horizontal the cross-wire will bisect the bubble, and will determine the level of any object seen through the telescope, thus securing to the observer a clear view of the object, magnified by the telescope.

The Binocular Hand Level, shown as No. 641, consists of two tubes, the one on the right enclosing the usual lenses of the opera glass, and the tube on the left containing only the prism, level-vial and cross-wire of the instrument just described. This level is used like the ordinary opera glass, being held with the level-vial above, as shown in the cut.

When the tubes are held truly horizontal, the engineer will see with one eye the cross-wire bisecting the bubble, and with the other eye will see the object observed, the level line of which is determined by the position of the cross-wire upon the surface of the level-vial.

The Binocular Hand Level gives a clearer view of an object than is possible with a single tube, there being no light lost by the interference of the prism and the level-vial.

The hand level is adjusted by sliding the prism tube back and forth, until the line given is the same as that given by a Y Level.

The prism in the tube can be reached by removing the cap from the closed end of the tube, and it is clamped by a small screw on the lower side.

LOCKE HAND LEVEL

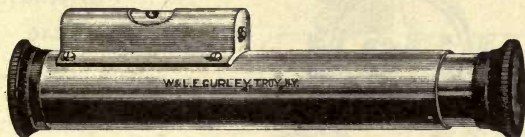

No. 643.

Price, \$8.00.

This instrument consists of a brass tube about six inches long, having a level-vial on top and near the object end, as shown in the figure. There is an opening in the tube beneath, through which the bubble can be seen, as reflected by a prism immediately under the level-vial. Both ends of the tube are closed by disks of plain glass to exclude dust, and there is at the inner end of the sliding or eye tube a semi-circular convex lens, which serves to magnify the level-bubble and the cross-wire beneath, while it allows the object to be clearly seen through the open half of the tube.

The cross-wire is fastened to a frame moving under the level-tube, and adjusted to its place by the small screw shown on the end of the level-case. The level of any object in line with the eye of the observer is determined by sighting upon it through the tube, and bringing the bubble of the level into a position where it is bisected by the cross-wire.

ABNEY LEVEL
AND CLINOMETER

No. 646

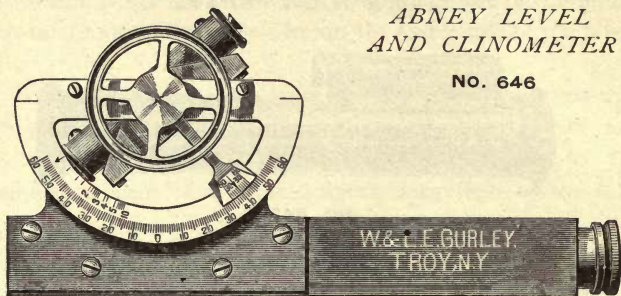

The Abney Level is a modification of the Locke Hand Level, combining with it an excellent clinometer, as shown in the cut.

The main tube being square, it can be applied to any surface, the inclination of which is ascertained by bringing the level-bubble into the middle, and reading off the angle to five minutes by the arc and vernier. When sighted at an object and the bubble brought into the middle, the vertical angle from the height of the eye is indicated. When at zero it would indicate a level line.

The inner and shorter arc indicates the lines of different degrees of slope, the left edge of the vernier plate being applied to the lines, and the bubble brought into the middle as usual. A small compass, with needle about one and one-half inches long, is sometimes attached to the upper surface of the Abney Level, with a plain staff socket below.

PRICES

No.		PRICE	POST.
646	Abney Level, an improved Locke Hand Level, giving angles of elevation, and also divided for slopes, as 1 to 1, 2 to 1, etc.; in case.....	\$13.50	\$0.25
648	Same as No. 646, and with compass and plain staff socket attached.....	18.00	.30

CHAINS

The sizes and diameters of iron and steel wire commonly used in making surveyors' and engineers' chains are as follows: No. 8, .162-inch; No. 10, .135-inch; No. 12, .105-inch; No. 15, .072-inch; No. 18, .047-inch.

The ordinary Gunter's or surveyors' chain is sixty-six feet or four poles long, and is composed of one hundred links, connected each to each by two rings, and furnished with a tally mark at the end of every ten links. A link in measurement includes a ring at each end, and is seven and ninety-two one-hundredths inches long. In all the chains which we make the rings are oval and are sawed and well closed, the ends of the wire forming the hook being also filed and bent close to the link, to avoid kinking. The oval rings are about one-third stronger than round ones.

HANDLES The handles are of brass and form part of the end links, to which they are connected by a short link and jam-nuts, by which the length of the chain is adjusted.

TALLIES The tallies are of brass, and have one, two, three or four notches, as they mark ten, twenty, thirty or forty links from either end. The fiftieth link is marked by a rounded tally to distinguish it from the others.

HALF-CHAINS In place of the four-pole chain just described, many surveyors prefer a chain two rods or thirty-three feet long, having only fifty links, which are counted by tallies from one end in a single direction.

Our surveyors' chains are made of Nos. 8 and 10 refined

iron wire, and of Nos. 8, 10, 12 and 15 best steel wire.

IRON AND STEEL WIRE Steel chains are often preferred on account of their greater strength, although they are more costly than those of iron.

Engineers' chains differ from surveyors' chains, in that

ENGINEERS' CHAINS a link including a ring at each end is one foot long, and the wire is of steel and therefore much stronger.

They are either fifty or one hundred feet long, and are furnished with swivel handles and tallies like those just described. The wire used for these chains is of steel of the first quality, Nos. 8, 10 and 12.

A very light and strong chain is made of No. 12 steel

BRAZED STEEL CHAINS wire, the links and rings of which are securely brazed. The wire is of a low spring-temper, and the chain, though light, is almost incapable of being broken or stretched in careful use.

Our brazed steel chains have been found exceedingly desirable for all kinds of measurement, and for the use of engineers upon railroads and canals they have very generally superseded the heavier chains.

We frequently make chains with steel snaps in the middle and at one handle. The chain can then be

STEEL SNAPS separated, and one handle being removed and transferred to the forty-ninth link, a chain of half length is obtained. This modification is made without charge, if ordered with the chain.

In using the chain the length must be taken from the

TO USE THE CHAIN extreme ends, and the marking-pins placed on the outside of the handles. It must be drawn straight and taut, and carefully examined to detect any kinks or other causes of inaccuracy.

Our chains are carefully tested at every link and in their whole length, by the U. S. standard, with a strain of ten pounds and with temperature at 62° Fahrenheit; and when new they may always be relied upon as correct.

All chains will be more or less lengthened after long use in the field, and it will be best for the surveyor to lay down on a level surface the exact length of the chain when new, marking its extreme ends by monuments which will not be liable to disturbance. He will thus have a standard measure of his own to which the chain can be adjusted from time to time.

GRUMMAN'S PATENT CHAINS

These chains, invented and patented by J. M. Grumman, of Brooklyn, N. Y., are made of very light steel wire, the links being finely tempered, and, as shown in the cut, so formed at the ends as to fold together readily, and thus dispense with the use of rings.

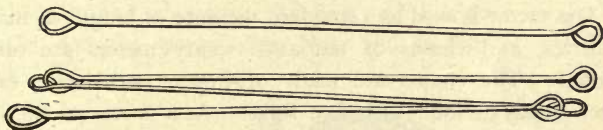

This construction gives but one-third as many wearing points as are in the ordinary chain, and affords the utmost facility for repairs.

Five or ten extra links are furnished with each chain, and these have only to be sprung into place to replace any which may have been broken. The chain can also be sprung apart at any link, and be made of any length desired.

Some of these chains are made of No. 15 wire, and are

used for measuring on the surface, like the ordinary chain. One is used as a suspended chain for very accurate measurements, and is of No. 18 wire and provided with spring-balance, level and thermometer attachments. When in use it is held above the surface, and the extremities of the chain are marked upon the ground by the points of plummets let fall from fixed places on the chain.

VARA CHAINS

The vara, which is in general use in Texas, is 33.333 inches long. The chains are made both of iron and steel wire, ten or twenty varas in length, each vara being usually divided into five links. A link, including a ring at each end, is therefore 6.666 inches long. A ten-vara chain has fifty links, a twenty-vara chain one hundred links. Each vara is marked by a round brass tally, numbered from one to nine in the ten-vara chain, and from one to nineteen in the twenty-vara chain.

METER CHAINS

The meter is used as a standard measure of length in many countries, and chains of ten and twenty meters are often ordered. The chains are made of iron or steel wire, each meter being divided into five links. As a meter is 39.371 inches long, a link, including a ring at each end, measures 7.874 inches.

A ten-meter chain has fifty links and a twenty-meter chain one hundred links. Each meter is marked with a round brass tally numbered from one to nine in the ten-meter chain, and from one to nineteen in the twenty-meter chain.

MARKING-PINS

In chaining, eleven marking-pins are needed, made either of iron, steel or brass wire, as preferred. They are about fourteen inches long, pointed at one end to enter the ground, and formed into a ring at the other end for convenience in handling.

Marking-pins are sometimes loaded with a little mass of lead around the lower end, to serve as a plumb when the pin is dropped to the ground from the suspended end of the chain.

CHAIN TAPES

Chain tapes are generally used on bridge, road and street work, and as standards for comparison of other chains and tapes. They are made of a thin ribbon of steel about one-quarter of an inch wide, and of straight spring-temper, and commonly in lengths of from thirty-three to five hundred feet.

The thirty-three and sixty-six feet lengths are usually graduated at each Gunter's link for use in land surveying, and the fifty and one hundred-foot lengths are graduated at each foot, and also have the first and last foot marked in tenths, for city work. See Nos. 760 to 768 of the Price List.

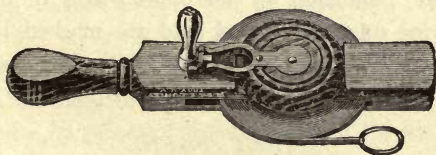

No. 760

A convenient reel for these tapes is shown in the cut. When not in use the handle of the drum can be folded flat, and a small projection at its base fits into a slot made to

receive it, and thus clamps the drum and prevents the tape from unwinding.

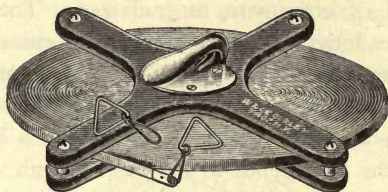

NO. 770

The tapes from three hundred to five hundred feet in length are usually graduated at each five feet, with the first and last five feet marked at each foot. They are wound upon a substantial wooden reel with aluminum and brass mountings, as shown above. See Nos. 770 to 772 of the Price List.

Our chain tapes are U. S. standard measure at 62° Fahrenheit, and with ten pounds strain.

METALLIC TAPES

These are of linen, about five-eighths of an inch wide, and have fine brass wires interwoven through their whole length. They are thus measurably correct, even when wet.

They are graduated in feet and tenths or in feet and inches, on one side, as ordered, and are marked in links on the reverse side. They are wound in a leather case having a folding handle. See Nos. 780 to 794 of the Price List.

STEEL TAPES

The best tapes are made of a thin ribbon of steel in one piece, of straight spring-temper, and either one-quarter, three-eighths or one-half inch wide.

They are made in all lengths from twenty-five to one hun-

dred feet, graduated to feet and inches, with links on the reverse side, or more usually feet and tenths of a foot, with links on the reverse side, the figures and graduations being etched on the surface of the steel.

American steel tapes (Paine's pattern) are made of thin steel ribbon in one piece, about one-quarter of an inch wide and of straight spring-temper. They can be detached from the case when desired, and used with a pair of handles with compensation scale for variations of temperature, for chain measurements.

These tapes are U. S. standard measure at 62° Fahrenheit, with about twelve pounds strain. A hundred-foot tape expands .0756 inch for each 10° rise in temperature.

The tapes are wound in a leather or metal case with folding handle. See Nos. 800 to 835 of the Price List.

Our Excelsior steel tape is well liked for use in mines. It is one-half inch wide, and is mounted on an open brass frame with folding handle. The tape is easily wound and unwound, and the open frame allows the evaporation of moisture. See Nos. 850 to 859B of the Price List.

METRIC AND VARA TAPES

We can furnish any of our metallic tapes, Nos. 780 to 794, and steel tapes, Nos. 820 to 835, with metric or vara measure on the reverse side instead of links, at extra prices, as quoted on pages 294 and 296; and with metric or vara measure only, at prices of regular styles of the same length in feet. Our chain tapes, Nos. 760 to 772, are also graduated with metric measure only, when so ordered, and are marked at each meter, with the first and last meter in decimeters. If graduated with vara measure only, they are marked at each vara, with the first and last vara in tenths.

INFORMATION TO PURCHASERS

SELECTION OF INSTRUMENTS

THE PLAIN COMPASS will answer for original surveys, or for ascertaining the bearing of lines in the preparation of county maps.

The VERNIER COMPASS, or VERNIER TRANSIT COMPASS, will be required where allowance must be made for the magnetic declination, as in retracing the lines of an old survey.

When local attraction must be taken into account, in addition to the magnetic declination, and angles must be taken independently of the needle, an instrument with a graduated limb must be used, and for this purpose the RAILROAD COMPASS will be suitable.

For a mixed practice of general surveying, including farm and city work, the establishment of grades and the running of levels, such an instrument as the SURVEYORS' TRANSIT, with its various attachments, is amply sufficient.

The different forms of the ENGINEERS' TRANSIT, the MOUNTAIN TRANSIT, and the Y LEVELING INSTRUMENTS are designed for engineering work of the highest class.

In the United States public land surveys, an instrument with solar attachment is required, and the SOLAR TRANSIT is usually selected.

In surveys of mining claims, especially in locations difficult of access, and for the survey of mines in general, the MOUNTAIN TRANSIT, with the solar attachment and other attachments, has proved a universal favorite.

The various PLANE-TABLE outfits have a recognized utility for topographical work and map drawing.

The CURRENT METERS are almost indispensable in measuring the velocity of the flow of water in harbors, rivers, small streams and irrigation ditches.

The DRAINAGE LEVEL is the simplest and most efficient instrument designed for laying out drains and similar work.

The ARCHITECTS' LEVEL and the BUILDERS' TRANSIT are used in laying out buildings, determining the level of their floors, sills and windows, and in the general work of the builder.

The EXPLORERS' TRANSIT, the RECONNOISSANCE TRANSIT and the various forms of POCKET COMPASSES, with or without telescopic attachment, are very desirable for a large class of work where extreme lightness and portability are desirable.

Where iron ores are to be traced, the MINERS' DIP-COMPASS, the DIAL COMPASS and the POCKET SOLAR COMPASS are used. We do not make any instrument by which veins of gold and silver can be traced, or the presence of these metals detected.

LOW PRICE OF OUR INSTRUMENTS

It is often stated that it is impossible to make first-class instruments at our prices, which are much lower than those of other skillful manufacturers. To this we can only reply that a visit to our works, and a comparison of our facilities with those of any other manufacturer will dispel all doubts as to our ability to furnish the best instruments for the money that can be produced in this country.

Our instruments are not carried in stock by merchants, and we do not deem it advisable to add to our prices in order

to enable us to give to merchants a large discount, which, of course, would be paid by the purchaser.

TERMS OF PAYMENT

Our terms of payment are uniformly cash and we have but one price, whether ordered in person or by mail or telegraph. Our prices are as low as can be made for instruments of first quality.

Remittances may be made by a cashier's draft payable to our order, which can be procured from banks or bankers in almost all the larger villages, or by express company or post-office money orders. These may be sent by mail with the order for the instrument, and if lost or stolen on the way can be replaced by a duplicate obtained as before, without additional cost. The customer may also send the money in advance by registered mail or by the express agent, or may pay the agent on receipt of the instrument in funds current in New York.

The cost of returning the money on bills amounting to less than \$20, collected by express, will be charged to the customer.

When articles are to be sent by mail payment must be made in advance, including the cost of postage. The postage required is mentioned in the second column of the Price List.

Customers ordering instruments and desiring changes in construction from our regular patterns must make a payment in advance, with the order, of fifty per cent. of the price.

WARRANTY

All our instrument are very critically tested before shipment, and are sent to the purchaser adjusted and ready for immediate use.

When purchased directly from us they are warranted cor-

rect in all their parts, we agreeing, in the event of any defect appearing after reasonable use, to repair or replace with a new and perfect instrument, promptly, and at our own cost, express charges included; or we will refund the money and the express charges paid by the customer.

It will sometimes happen, in a business as large and widely extended as ours, that instruments reach our customers in bad condition, owing to careless transportation or to defects escaping the closest scrutiny of the maker. We consider the retention of such instruments by the purchaser an injury very much greater to us than to himself.

TRIAL OF INSTRUMENTS

This statement may be read by those who are entirely unacquainted with us or the quality of our work, and who therefore feel unwilling to purchase an instrument, of the excellence of which they are not perfectly assured.

To such persons we make the following proposition: If requested to do so, we will send the instrument to the express station nearest the purchaser, and direct the express agent to collect our bill on delivery, together with charges for transportation, and hold the money on deposit three days, if desired, until the purchaser shall have had an actual trial of the instrument.

If the instrument is not found as represented, the purchaser may return it before the expiration of the specified time, and receive in full the money paid the agent, including express charges, and direct the instrument to be returned to us.

This privilege of trial applies only to our larger transits, levels, and compasses, is not given unless requested, and is allowed only in the United States.

EXTENT OF OUR PLANT

For many years our facilities for manufacturing have been far superior to those of any other similar establishment in the world, and they are being constantly increased by the introduction of new machinery and tools.

We now make under our own roof the lenses for the telescopes of our instruments, the glass vials for the level-tubes, the wooden boxes in which the instruments are packed, and the leather cases and straps for these boxes, as well as all the metal parts of the instruments themselves.

FINISH OF INSTRUMENTS

All instruments are covered with a lacquer applied while the work is heated. As long as this lacquer remains the brass surface will not tarnish, and the engineer can preserve its original freshness for a long time by taking care not to rub the instrument with a dusty cloth or expose it to the friction of his clothes.

Instead of the brass finish, most engineers prefer instruments blackened or bronzed. This is done with an acid preparation, after the work has been polished, and gives the instrument a very showy appearance. It is also advantageous because it does not reflect the rays of the sun as much as the bright or brass finish.

If no special direction is given, we usually send transits, levels, and solar instruments with bronze finish, and compasses with bright finish.

ALUMINUM

Since 1876 we have made civil engineers' and surveyors' instruments of aluminum, to order only. The sole advantage which instruments of aluminum have over those of the

ordinary metals is their light weight ; but as all the bearing parts must be made of bronze, the total weight can be reduced only about fifty per cent. We finish our aluminum instruments in the natural color, and the result is more satisfactory than when an artificial coloring is used, although it entails much extra expense upon the manufacturer. We will quote prices on application for any of our instruments of regular pattern made of aluminum.

PACKING

Each of our transits, levels, and surveyors' compasses is packed in a well-finished mahogany case, furnished with lock and key and brass hooks, and leather strap for convenience in carrying. Each case is provided with screw-driver, adjusting-pin and wrench for center-pin, and, if accompanied by a tripod, with a brass plummet. With all the instruments used for taking angles without the needle, a reading-glass is also furnished.

Unless the purchaser is already supplied, each instrument is accompanied by our Manual, giving full instruction for such adjustments and repairs as are possible to one not provided with the facilities of an instrument-maker.

When sent to the purchaser, the mahogany cases are enclosed in outside packing-boxes of pine, made a little larger on all sides to allow the introduction of elastic material. So effectually are our instruments protected by these precautions, that of very many thousands sent out since 1846, in all seasons and by every mode of transportation, and to all parts of the world, very few have sustained any serious injury.

Instruments packed for foreign shipment, which are to have ocean passage, are hermetically sealed in tin cases.

MEANS OF TRANSPORTATION

Instruments can be sent by express to almost every town in the United States, Canada and Mexico, agents being located at all the more important points, by whom they are forwarded to smaller places by stage.

Charges for transportation are in all cases to be borne by the purchaser, we guaranteeing the safe arrival of our instruments at his express office, and holding the express company responsible for loss and damage on the way.

INSTRUMENTS FOR FOREIGN COUNTRIES

We send civil engineers' and surveyors' instruments to Canada, Mexico, Central America, Cuba, South America, China, Japan, Australia, Africa and India, as well as to various parts of Europe.

In every case, the cash for orders for foreign shipments by steamship must accompany the order. If it is desired that we attend to the shipment of the instruments, the remittance must be made ten per cent. more than the catalogue price of the instruments if the order amounts to \$250 or less, eight per cent. more than the catalogue price if the order amounts to from \$300 to \$500, or six per cent. more than the catalogue price if the order amounts to from \$600 to \$1,000. The extra remittance is to cover the cost of shipping charges, freight and insurance, which must always be paid in advance on all shipments except those to Canada and some parts of Mexico.

If the amount remitted is more than sufficient to cover these expenses, any balance will be returned to the purchaser with the receipted bill and bill of lading, unless we are directed to hold it to his credit and subject to his order.

Remittances must be made by bankers' draft on London,

England, or on New York city, and such drafts can be purchased in any of the large cities of the countries named above.

When telegraphing cable messages to us, use either the Western Union or the Lieber code.

REPAIR OF INSTRUMENTS

We receive every year more than a thousand instruments of our own and others' make, sent to us for refitting and repairs. Most of these have been injured by falls, many have parts worn and defective after long use, and others are sent for repolishing and renovating.

The injuries are usually more serious than is apparent to the owner, and their full extent can be ascertained only by an examination as the instrument is taken apart.

We advise our customers who have instruments in need of repairs to send them directly to us, as our facilities enable us to do the work much more economically and promptly than any other maker, however accessible.

The instruments should always, when practicable, be placed in their own boxes, and then enclosed in an outside packing case, an inch larger in all its dimensions, that the space between the two may be filled with paper wadding, hay or fine shavings. THE OWNER'S NAME AND ADDRESS should always appear on the package, and a note specifying the repairs needed should always accompany the instrument, and a letter should also be sent to us by mail, giving not only directions as to the repairs, but also stating when the return of the instrument is desired and the address to which it should be forwarded.

Each instrument is made to fit its own spindle, and no other; and therefore this part, with the leveling-head, if it has one, should always be sent with the instrument. The

tripod legs and the head in which they are inserted need not be sent, unless themselves in need of repairs.

When requested to do so, we will send an estimate of the cost of repairs to any instrument sent us, before beginning the work.

Compasses come to us with the plates sprung, the sights bent or broken, the glass or level-vials fractured, and the pivot so dulled as to render the needle sluggish and unreliable.

**REPAIRS TO
COMPASSES**

The cost of repairing these defects ranges from \$2 to \$10. A pair of new sights fitted costs \$5; a new needle with jeweled center and pivot complete, \$3; a new jeweled center only, \$1.50; regraduating the compass circle, \$5. In case of any trouble with the needle it is always best to send the needle and center-pin to us by mail, with \$3.10, and we will then either repair and return the parts, with any balance due the owner, or we can send new needle and center-pin complete, by registered mail postpaid. We are in daily receipt of compass needles sent to us for repairs from all parts of the country.

A compass sent for repairs should always be accompanied by the ball-spindle; and if a new ball-spindle is required, the whole instrument, or at least the socket in which the spindle fits, should be forwarded to us. A new ball-spindle, fitted, costs \$3. See also page 264.

Repairs to Railroad Compasses cost from \$10 to \$20, and to Solar Compasses from \$20 to \$50. Regraduating the horizontal limb and vernier to read to one minute costs \$10.

The injuries which Engineers' and Surveyors' Transits sustain by falls are usually much more serious. The plates, standards and cross-bars of telescopes are often bent, and sockets or centers are generally so deranged as to be entirely useless.

**REPAIRS TO
TRANSITS**

The cost of repairing an instrument with such injuries ranges from \$10 to \$30 or even \$50, new sockets alone costing from \$15 to \$20. See also page 264.

Variation plate added to an Engineers' Transit sent for repairs, costs.....	\$15.00
Regraduating horizontal limb and vernier to read to one minute, costs.....	10.00
Regraduating vertical limb and vernier to read to one minute, costs.....	5.00

No one but a skilled workman provided with the best facilities can properly set the platinum wires in a cross-wire **PLATINUM** diaphragm, and it is, therefore, useless for **CROSS-WIRES** us to send a parcel of wires for that purpose. The only way in which they can be replaced without sending the telescope to us is to take out the ring and send it, with its screws, washers, etc., and we will return it with the wires properly secured.

Plain platinum cross-wires, replaced on the old ring, cost.....	\$2.00
Adjustable platinum stadia wires, replaced on the old ring, cost.....	3.00
Fixed platinum stadia wires, replaced on the old ring, cost.....	5.00

If to be sent by mail, add 15 cents for postage and registry, and 25 cents for a safety brass packing-box.

We are not responsible for wires sent in this way and broken while inserting the ring in the telescope. The best plan is to send us the telescope when new cross-wires are needed.

When it is desirable to substitute platinum for spider-web, a new ring with screws will be required, and the telescope should be sent to us.

Plain platinum cross-wires, with diaphragm, screws, etc., cost.....	\$3.00
Adjustable platinum stadia wires, with diaphragm, screws, etc., cost.....	5.00
Fixed platinum stadia wires, with diaphragm, screws, etc., cost.....	7.00

See also pages 8 to 10.

Leveling-instruments are generally much less injured by falls than transits. The damages usually consist in the bending of the bar, the springing of the sockets, and the breaking of the vial.

The cost of repairs varies from \$5 to \$20. A new level-set in the old tube costs \$1.25 to \$2.50, according to the size of the level. See also page 265.

REPAIRS TO LEVELS The cost of repolishing an instrument varies, but may be stated generally as follows:

COMPASSES, Plain and Vernier.....	\$ 5.00 to \$ 7.00
RAILROAD COMPASSES	8.00 to 10.00
SOLAR COMPASSES, large size.....	12.00 to 15.00
TRANSITS	12.00 to 15.00
Y LEVELS.....	8.00 to 12.00

These prices are in addition to the cost of adjustment and of any necessary repairs. No additional charge is made for bronzing or blackening an instrument when repolished.

Payment for repairs may be made at the express office where the instrument is received, the customer paying in advance for the transportation of the instrument to us or not, as he may prefer. Whenever the charges are paid in advance, the express receipt should be mailed directly to us.

PRICES FOR PARTS OF INSTRUMENTS
 LIABLE TO LOSS OR INJURY
 FOR TRANSITS

	PRICE	POST.
Needle with jeweled center and center-pin.....	\$3.00	\$0.10
Center-pin only50	.01
Ground glass level-vial for plate or standard, each.....	.35	.02
Ground glass level-vial, brass mounted complete, for plate or standard, each.....	2.00	.12
Ground glass level-vial for telescope	1.25	.12
Cap for eyepiece or objective, each75	.03
Shade for objective.....	.75	.03
Clamp screw for horizontal limb.....	.75	.02
Tangent screw for leveling-head.....	.75 to 1.50	.11
Clamp screw for leveling-head75	.03
Leveling-screw for leveling-head.....	1.00 to 1.50	.12
Eyepiece complete	6.00	.12
Objective complete.....	6.00	.12
Platinum cross-wires and diaphragm	3.00	.15
Platinum stadia wires, adjustable, and diaphragm	5.00	.15
Platinum stadia wires, fixed, and diaphragm.....	7.00	.15
Mahogany box with lock and strap, and fitted inside.....	\$5 to \$6	

FOR SURVEYORS' COMPASSES

Needle with jeweled center and center-pin	\$3.00	\$0.10
Center-pin only.....	.50	.01
Ground glass level-vials, each.....	.35	.02
Ground glass level-vials, brass mounted complete, each.....	2.00	.12
Brass cover for Compass of our make.....	1.00	.25
Outkeeper	1.00	.11
Glass circle for compass face.....	.25	.15
Wrench for center-pin10	.01
Staff mountings, brass head, without spindle.....	2.00	.25
Staff mountings, steel point.....	.50	.18
Ball-spindle, fitted to old socket.....	3.00	.30
Compass sight vanes, each.....	2.50	.20
Clamp screw for spindle or sight vane.....	.50	.03
Tangent screw for moving vernier	1.50	.10
Staff mountings complete for Pocket Compass, small.....	2.50	.15
Staff mountings complete for Pocket Compass, large.....	3.50	.20
Mahogany box with lock and strap, and fitted inside.....	\$4 to \$6	

PRICES FOR PARTS OF INSTRUMENTS FOR Y LEVELS

	PRICE	Post.
Ground glass level-vial, unmounted, for 22-inch Y Level...	\$1.85	\$0.15
Ground glass level-vial, unmounted, for 15-20-inch Y Levels.	1.65	.15
Ground glass level-vial, extra sensitive (ten seconds in one-tenth of one inch), unmounted, for 18-, 20-, or 22-inch Y levels.	4.00	.15
Ground glass level-vial, unmounted, for Architects' Level90	.05
Cap for eyepiece or objective, each.....	.75	.03
Clamp screw for leveling-head75	.03
Tangent screw for leveling-head.....	.75 to 1.50	.11
Leveling-screw for leveling-head, each.....	1.00 to 1.50	.12
Eyepiece complete	6.00	.12
Objective complete.....	7.00	.12
Platinum cross-wires and diaphragm.....	3.00	.15
Platinum stadia wires, adjustable, and diaphragm	5.00	.15
Platinum stadia wires, fixed, and diaphragm.....	7.00	.15
Mahogany box, with lock and strap, and fitted inside..	\$4.50 to \$6	

MISCELLANEOUS

Plain tripod legs only, for Engineers' Transit or Level, per set	\$5.00	
Split tripod legs only, for Engineers' Transit or Level, per set	7.00	
Extension tripod legs only, for Engineers' Transit or Level, per set	10.00	
Clamp screw and band for extension leg, each.....	.85	\$0.05
Tripod head only, with bolts and nuts, for Engineers' Transit or Level.....	5.00	.50
Wooden cap with brass screw-plate, to fit tripod head.....	.75	.12
Brass bolt and nut to fit tripod head, each.....	.50	.05
Metal point or shoe for tripod leg, each50	.05
Leather ring to bind tripod legs together.....	.10	.02
Leather strap and buckle for Transit or Level Box.....	.50	.15
Leather strap and handle for carrying extension tripod50	.10
Steel screw-driver with wooden handle25	.05
Steel adjusting-pins, each05	.01
Rubber tips, for bottom of instrument box, per set.....	.40	.08
Reading-glass, for Transit.....	.75	.02
Brass Plummet with screw cap, for Transit or Level.....	1.50	.20
Waterproof hood, for Transit or Level.....	1.00	.06
Chamois skin, large size, best quality.....	.65	.05
Clamp with scale and clamp screw, for New York rod.....	3.00	.15
Clamp with scale and clamp screw, for Philadelphia rod....	3.00	.15
Target with clamp screw and spring, for New York or Philadelphia rod.....	4.50	.35
Chain handle, with staple and nuts, each75	.08
Chain tallies, per set of 9.....	.50	.06

SPECIAL NOTICE

A Transit with plain telescope is one without any attachments or extras, such as the clamp and tangent, vertical circle and level.

The telescopes of our Transits Nos. 1 to 17, 25 to 90 and 110 to 117 are furnished with rack and pinion movement to both eyepiece and objective, without extra charge.

In Transits Nos. 20, 100, 102 and 105 the objective is focused by a rack and pinion and the eyepiece by a spiral movement.

We have recently introduced an important modification of the telescopes used on all our Transits, so that they can be focused on an object as near as four and one-half feet from the center of the instrument.

Our Transits Nos. 1 to 105 are furnished with shifting-center to the leveling-head, and with a tripod and leveling-screws, and clamp and tangent to spindle. Transits Nos. 20, 25 to 31, 100 and 102, have tripods with extension legs. For prices of plain, split-leg and extension tripods see pages 280 and 281.

The limbs of our Transits Nos. 1 to 102 are graduated on sterling silver. The graduation is usually to half-degrees, and is read by vernier to single minutes. A finer graduation is furnished, if desired, at an extra cost. See pages 14 to 18 and page 275.

The vertical circles and vertical arcs are graduated on sterling silver. The circle of $3\frac{1}{2}$ inches diameter is graduated to degrees, and is read by vernier to 5 minutes. The circles of $4\frac{1}{2}$ and 5 inches diameter and the arc of $2\frac{1}{2}$ inches radius are graduated to half-degrees, and are read by vernier to 1 minute. The arc of 3 inches radius is graduated to 20 minutes and is read by vernier to 30 seconds.

A variation arc furnished with a new Engineers' Transit, Nos. 1 to 16, costs extra \$4.00. See No. 130, page 274.

Our Transits Nos. 17 to 102 and 110 to 117 have a variation arc for setting off the magnetic declination.

A leveling tripod head with plates, leveling-screws and clamp and tangent movement, fitted to Vernier Transits, costs extra \$13.00. See No. 176, pages 132 and 275.

Unless otherwise ordered, platinum stadia wires are always furnished with every Mountain Transit, with all Solar Transits, and with the Reconnaissance Transits.

Stadia wires are furnished without extra charge if requested when ordering any new Transit. When desired, we arrange the stadia wires to disappear, or be out of focus, when the plain cross-wires only are in use. See pages 9 and 262 to 264.

A dust guard to the objective slide is furnished without charge with new Transits Nos. 1 to 90 and 110 to 117; but if furnished with new Transits Nos. 100, 102, or 105, the extra cost is \$4.00. See pages 11, 162 and 275.

Reflectors to the limb verniers are always furnished with Mountain Transits Nos. 25 to 31, and are also furnished without charge, if requested, with new Transits Nos. 1 to 20 and 35 to 90; but if furnished with a new Transit Nos. 100 to 102, the extra cost is \$1.50.

Each Transit is packed in a mahogany case, with lock and leather strap, and has a plummet, reading-glass, adjusting-pins, etc. The wood box for the Explorers' Transit is leather covered. The box for the Mountain Transit has an outside sole-leather case with shoulder straps.

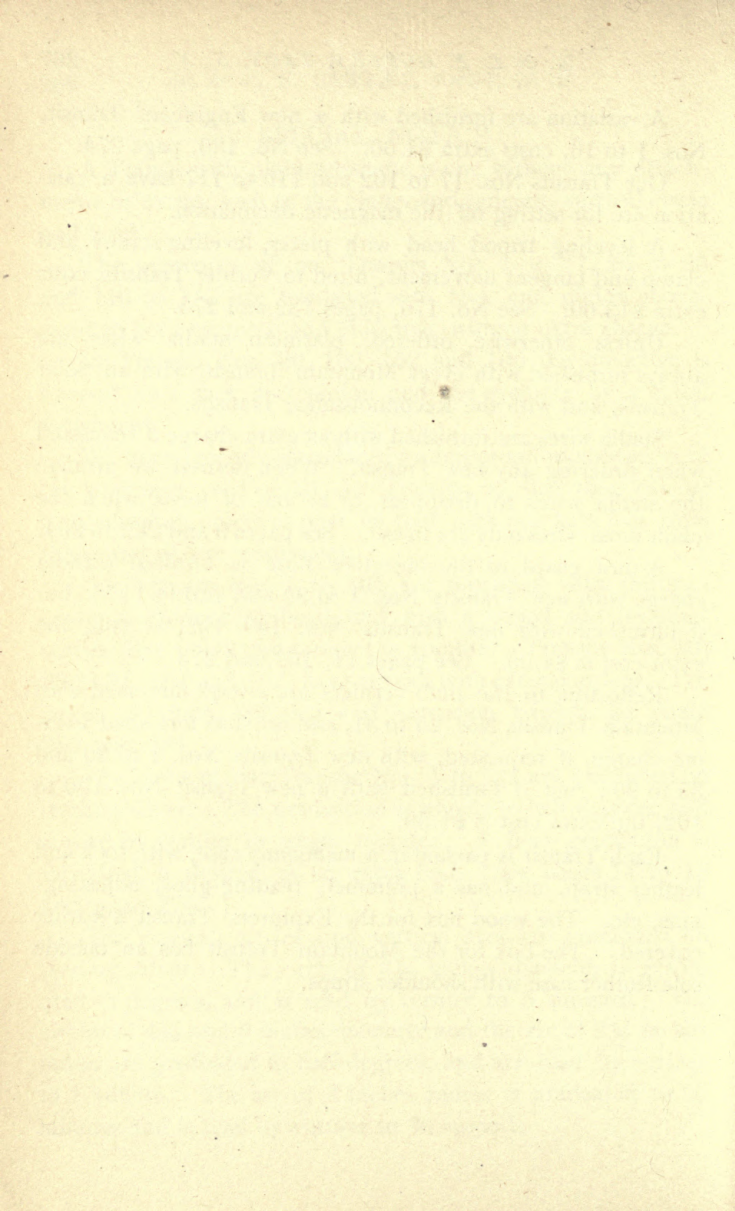

PRICE LIST
OF
CIVIL ENGINEERS'
AND
SURVEYORS' INSTRUMENTS
AND
SUPPLIES

PRICE LIST

FORTY-SECOND EDITION

TROY, N. Y., U. S. A., AUGUST, 1908

ALL PRICES IN THIS WORK ARE IN U. S. CURRENCY. STATE WHAT EDITION OF
MANUAL WHEN ORDERING GOODS, AND GIVE CATALOGUE NUMBER

This Price List supersedes all previous Editions

ENGINEERS' TRANSITS

No.		PRICE
1	Engineers' Transit, two verniers to limb, 4-inch needle, plain telescope.....	\$145.00
2	Engineers' Transit, two verniers to limb, 4-inch needle, with level on telescope and clamp and tangent to telescope axis	163.00
3	Engineers' Transit, two verniers to limb, 4-inch needle, with $4\frac{1}{2}$ -inch vertical circle, level on telescope and clamp and tangent to telescope axis.....	175.00
6	Engineers' Transit, two verniers to limb, $4\frac{1}{2}$ -inch needle, plain telescope.....	150.00
7	Engineers' Transit, two verniers to limb, $4\frac{1}{2}$ -inch needle, with level on telescope and clamp and tangent to telescope axis.....	168.00
8	Engineers' Transit, two verniers to limb, $4\frac{1}{2}$ -inch needle, with $4\frac{1}{2}$ -inch vertical circle, level on telescope and clamp and tangent to telescope axis.....	180.00
9	Engineers' Transit, two verniers to limb, $4\frac{1}{2}$ -inch needle, with vertical arc of 3 inches radius with vernier moved by tangent screw, level on telescope and clamp and tangent to telescope axis.....	186.00
10	Engineers' Transit, two verniers to limb, $4\frac{1}{2}$ -inch needle, with vertical arc of 3 inches radius with vernier moved by tangent screw, level on telescope and gradienter combined with clamp and tangent to telescope axis.....	198.00
12	Engineers' Transit, two verniers to limb, 5-inch needle, plain telescope, as shown on page 6.....	150.00
13	Engineers' Transit, two verniers to limb, 5-inch needle, with level on telescope and clamp and tangent to telescope axis	168.00
14	Engineers' Transit, two verniers to limb, 5-inch needle, with $4\frac{1}{2}$ -inch vertical circle, level on telescope and clamp and tangent to telescope axis.....	180.00

ENGINEERS' TRANSITS

No.		PRICE
15	Engineers' Transit, two verniers to limb, 5-inch needle, with vertical arc of 3 inches radius with vernier moved by tangent screw, level on telescope and clamp and tangent to telescope axis.....	\$186.00
16	Engineers' Transit, two verniers to limb, 5-inch needle, with vertical arc of 3 inches radius with vernier moved by tangent screw, level on telescope and gradienter combined with clamp and tangent, as shown on page 29.....	198.00
17	Engineers' Transit, two verniers to limb, 5-inch needle, with variation arc, Solar Attachment, vertical arc of 3 inches radius with vernier moved by tangent screw, level on telescope, and clamp and tangent to telescope axis, as shown on page 31.....	250.00

EXPLORERS' TRANSIT

20	Explorers' Transit, two verniers to limb, $2\frac{3}{4}$ -inch needle, with variation arc, 4-inch vertical circle, level on telescope and clamp and tangent to telescope axis, extension tripod with jointed legs. Instrument is packed in a mahogany case with leather cover and shoulder strap. See page 33.....	\$165.00
----	--	----------

LIGHT MOUNTAIN AND MINING TRANSITS

25	Light Mountain Transit, two verniers to limb, 4-inch needle, with variation arc, telescope of finest quality, power 20 diameters, extension tripod shortening to half length. The instrument is packed in a mahogany case, covered with a light sole-leather case, with straps for packing. With plain telescope.....	\$150.00
26	Light Mountain Transit, with level on telescope and clamp and tangent to telescope axis.....	168.00
27	Light Mountain Transit, with $4\frac{1}{2}$ -inch vertical circle, level on telescope and clamp and tangent to telescope axis.....	180.00
28	Light Mountain Transit, with vertical arc of $2\frac{1}{2}$ inches radius with vernier moved by tangent screw, level on telescope and clamp and tangent to telescope axis.....	186.00
29	Light Mountain Transit, with vertical arc of $2\frac{1}{2}$ inches radius with vernier moved by tangent screw, level on telescope and gradienter combined with clamp and tangent.....	198.00
30	Light Mountain Transit, with Solar Attachment, vertical arc of $2\frac{1}{2}$ inches radius with vernier moved by tangent screw, level on telescope and clamp and tangent to telescope axis, as shown on page 37.....	245.00
31	Light Mountain Transit, with Solar Attachment, Jones latitude arc complete, level on telescope and clamp and tangent to telescope axis. See page 91.....	300.00

SURVEYORS' TRANSITS

No.	WITH TWO VERNIERS TO LIMB	PRICE
35	Surveyors' Transit, two verniers to limb, 4-inch needle, plain telescope.....	\$125.00
36	Surveyors' Transit, two verniers to limb, 4-inch needle, with level on telescope and clamp and tangent to telescope axis	143.00
37	Surveyors' Transit, two verniers to limb, 4-inch needle, with $4\frac{1}{2}$ -inch vertical circle, level on telescope and clamp and tangent to telescope axis.....	155.00
45	Surveyors' Transit, two verniers to limb, 5-inch needle, plain telescope.....	130.00
46	Surveyors' Transit, two verniers to limb, 5-inch needle, with level on telescope and clamp and tangent to telescope axis	148.00
47	Surveyors' Transit, two verniers to limb, 5-inch needle, with $4\frac{1}{2}$ -inch vertical circle, level on telescope and clamp and tangent to telescope axis, as shown on page 40	160.00
48	Surveyors' Transit, two verniers to limb, 5-inch needle, with $4\frac{1}{2}$ -inch vertical circle, level on telescope and gradienter combined with clamp and tangent to telescope axis.....	172.00
55	Surveyors' Transit, same as No. 45, but with $5\frac{1}{2}$ -inch needle..	130.00
56	Surveyors' Transit, same as No. 46, but with $5\frac{1}{2}$ -inch needle..	148.00
57	Surveyors' Transit, same as No. 47, but with $5\frac{1}{2}$ -inch needle..	160.00
58	Surveyors' Transit, same as No. 48, but with $5\frac{1}{2}$ -inch needle..	172.00
60	Surveyors' Transit, two verniers to limb, 5-inch needle, with Solar Attachment, vertical arc of 3 inches radius with vernier moved by tangent screw, level on telescope and clamp and tangent to telescope axis, as shown on page 47.....	226.00

SURVEYORS' TRANSITS

WITH ONE VERNIER TO LIMB

No.		PRICE
65	Surveyors' Transit, one vernier to limb, 4-inch needle, plain telescope.....	\$110.00
66	Surveyors' Transit, one vernier to limb, 4-inch needle, with level on telescope and clamp and tangent to telescope axis	128.00
67	Surveyors' Transit, one vernier to limb, 4-inch needle, with 4½-inch vertical circle, level on telescope and clamp and tangent to telescope axis.....	140.00
75	Surveyors' Transit, one vernier to limb, 5-inch needle, plain telescope.....	115.00
76	Surveyors' Transit, one vernier to limb, 5-inch needle, with level on telescope and clamp and tangent to telescope axis, as shown on page 44.....	133.00
77	Surveyors' Transit, one vernier to limb, 5-inch needle, with 4½-inch vertical circle, level on telescope and clamp and tangent to telescope axis.....	145.00
78	Surveyors' Transit, one vernier to limb, 5-inch needle, with 4½-inch vertical circle, level on telescope and gradienter combined with clamp and tangent to telescope axis.....	157.00
85	Surveyors' Transit, same as No. 75, but with 5½-inch needle.....	115.00
86	Surveyors' Transit, same as No. 76, but with 5½-inch needle.....	133.00
87	Surveyors' Transit, same as No. 77, but with 5½-inch needle.....	145.00
88	Surveyors' Transit, same as No. 78, but with 5½-inch needle.....	157.00
90	Surveyors' Transit, one vernier to limb, 5-inch needle, with Solar Attachment, vertical arc of 3 inches radius with vernier moved by tangent screw, level on telescope and clamp and tangent to telescope axis.....	211.00

RECONNOISSANCE TRANSIT

100	Reconnaissance Transit, one vernier to limb, 3½-inch needle, with 3½-inch vertical circle, level on telescope and clamp and tangent to telescope axis, leveling-screws, and clamp and tangent to spindle, and extension tripod, as shown on page 49.....	\$115.00
102	Reconnaissance Transit, same as No. 100, but with 4½-inch vertical circle with vernier reading to one minute.....	122.00

BUILDERS' TRANSIT

No.		PRICE
105	Builders' Transit, with level on telescope, clamp and tangent to telescope axis and to limb and spindle, and with leveling-screws and tripod, as shown on page 51.....	\$80.00

VERNIER TRANSIT COMPASSES

110	Vernier Transit, 5-inch needle, plain telescope, compass tripod.....	\$ 70.00
111	Vernier Transit, 5-inch needle, with level on telescope and clamp and tangent to telescope axis.....	88.00
112	Vernier Transit, 5-inch needle, with 3½-inch vertical circle, level on telescope and clamp and tangent to telescope axis.....	96.00
115	Vernier Transit, 6-inch needle, plain telescope, compass tripod.....	75.00
116	Vernier Transit, 6-inch needle, with level on telescope and clamp and tangent to telescope axis.....	93.00
117	Vernier Transit, 6-inch needle, with 3½-inch vertical circle, level on telescope and clamp and tangent to telescope axis, as shown on page 53.....	101.00

ATTACHMENTS AND EXTRAS FOR TRANSITS

	PRICE	POST.	
130	Variation Arc added to a new Engineers' Transit, Nos. 1 to 16, if ordered with the Transit.....	\$ 4.00	
131	Variation Arc added to Transits when sent for repairs.....	15.00	
135	Vertical Circle, 3½ inches diameter, with vernier to 5 minutes, see pages 55 to 57.....	8.00	\$0.15
136	Vertical Circle, 4½ inches diameter, with vernier to 1 minute, see page 55.....	12.00	.20
137	Vertical Circle, 5 inches diameter, with vernier to 1 minute.....	15.00	.20
138	Vertical Circle, 5 inches diameter, with two opposite double verniers to 1 minute, see page 56.....	35.00	.35
139	Vertical Arc, 2½ inches radius, with vernier to 1 minute moved by tangent screw, see page 58.....	18.00	.20
140	Vertical Arc, 3 inches radius, with vernier to 30 seconds moved by tangent screw, see page 58.....	18.00	.20
141	Aluminum Guard for Vertical Circle, see page 57...	6.00	
145	Level on Telescope with ground vial and scale, see page 59.....	12.00	.25
148	Clamp and tangent to telescope axis, see page 59...	6.00	.13
149	Beam Stadia Arc attached to new Transit, see pages 62 and 63.....	15.00	
150	Gradienter combined with clamp and tangent, see page 64.....	18.00	.25

ATTACHMENTS AND EXTRAS FOR TRANSITS

No.		PRICE	Post.
151	Platinum Stadia wires, adjustable, and diaphragm....	\$ 5.00	\$0.15
152	Platinum Stadia wires, fixed, and diaphragm.....	7.00	.15
154	Dust Guard to objective slide, see page 11.....	6.00	
155	Rack and Pinion movement to eyepiece.....	5.00	
157	Sights on Telescope with folding joints, see page 61..	8.00	
158	Sights on Standards at right angles with telescope, see page 61.....	8.00	
160	Detachable Side Telescope and Counterpoise, for vertical sighting, see page 66.....	25.00	.50
161	Detachable Riding Telescope, for vertical sighting, see page 66.....	25.00	.50
165	Reflector for illuminating cross-wires, see page 67....	4.00	.15
166	Reflector for illuminating cross-wires of large Y Level.....	5.00	.15
168	Diagonal Prism for eyepiece of telescope, see page 67	8.00	.15
170	Plummet Lamp for Mine Engineering, see page 68...	10.00	.35
173	Quick-Leveling Attachment.....	6.00	.35
174	Quick-Leveling Attachment, if ordered with any new Transit Nos. 1 to 105.....	5.00	
176	Leveling-Head with plates, leveling-screws and clamp and tangent, fitted to Transits Nos. 110 to 117, see page 132.....	13.00	
180	Attached Magnifier with three universal joints, to read verniers, each.....	5.00	
185	Graduation of limb to read to 20 or 30 seconds, extra.....	10.00	
183	Graduation of limb to read to 10 seconds, extra.....	30.00	
187	Graduation of 4½ or 5-inch vertical circle to read to 20 or 30 seconds, extra.....	5.00	
188	Graduation of No. 138 Vertical Circle to read to 20 or 30 seconds, extra.....	10.00	
190	Solar Attachment with declination arc, hour circle and polar axis, see page 69.....	60.00	.30
192	Solar Screen to fit eyepiece of telescope, see page 89..	5.00	.12
193	Patent Latitude Level, for use with Solar Transit, see page 90.....	6.00	.15
195	Jones Latitude Arc, with reversible level, see page 91	73.00	
196	Striding or Adjusting-Level, see page 95.....	3.00	.15

For Tripods, see pages 186 to 189, and 280 and 281. For Leather Cases, see pages 190 and 282

SOLAR COMPASS

PRICE

210	Burt Solar Compass, with leveling-screws and clamp and tangent to spindle, and tripod, see page 107.....	\$210.00
-----	---	----------

For Pocket Solar Compass, see No. 275, and pages 142 and 277.

RAILROAD COMPASSES

No.		PRICE
215	Railroad Compass, two verniers to limb, limb reading to 1 minute, 5-inch needle, brass cover, outkeeper, and staff mountings.....	\$70.00
216	Railroad Compass, two verniers to limb, limb reading to 1 minute, 5½-inch needle, brass cover, outkeeper, and staff mountings, see page 114.....	75.00
220	Railroad Compass, one vernier to limb, limb reading to 1 minute, 5½-inch needle, brass cover, outkeeper, and staff mountings, see page 116.....	60.00

These Compasses should always be used on a tripod when practicable. Tripods Nos. 415, 420, and 425 are adapted for use with these Compasses.

VERNIER COMPASSES

225	Vernier Compass, 4-inch needle, brass cover, outkeeper, and staff mountings.....	\$30.00
226	Vernier Compass, 5-inch needle, brass cover, outkeeper, and staff mountings.....	35.00
227	Vernier Compass, 6-inch needle, brass cover, outkeeper, and staff mountings, see page 118.....	40.00

PLAIN COMPASSES

230	Plain Compass, 4-inch needle, brass cover, outkeeper, and staff mountings.....	\$25.00
231	Plain Compass, 5-inch needle, brass cover, outkeeper, and staff mountings.....	30.00
232	Plain Compass, 6-inch needle, brass cover, outkeeper, and staff mountings, see page 130.....	35.00

Compasses Nos. 210 to 232 are packed in mahogany case, with lock and leather strap. A Compass Tripod (our No. 415) will be furnished with any of these Compasses, Nos. 215 to 232, at an extra cost of \$5.00; and if the staff mountings are omitted we deduct \$2.00.

ATTACHMENTS AND EXTRAS FOR COMPASSES

	PRICE	POST.	
240	Compound Tangent Ball-Spindle, see page 131.....	\$ 9.00	\$0.30
241	Leveling-Adopter, large size, see page 131.....	7.00	.40
242	Leveling-Head with plates, leveling-screws and clamp and tangent, fitted to use with tripods Nos. 401, 406, 411, 415, 420, and 425, see page 132.....	13.00	
245	Compass Tripod Mountings, without the legs.....	4.00	.60

For Tripods, see pages 186 to 189 and 281. For Leather Cases, see pages 190 and 282.

TELESCOPIC SIGHT. Patented

ATTACHABLE TO COMPASS SIGHT. SEE PAGES 133 TO 139

No.		PRICE	Post.
261	Achromatic Telescope, 9-inch, power about 20 diameters, see page 133.....	\$18.00	\$0.45
262	Achromatic Telescope, 9-inch, same as No. 261, and with stadia wires.....	20.00	.50

We add to the Telescopic Sight the following extras, at prices named :

265	Vertical Circle, with vernier to 5 minutes	5.00	
266	Level on Telescope, with ground and graduated vial	5.00	
267	Clamp and Tangent to telescope axis	5.00	
268	Offset standard with counterpoise, to bring the telescope over the line of zeros.....	7.50	.50

POCKET SOLAR COMPASS

275	Pocket Solar Compass, one vernier to limb, limb reading to 1 minute, 3-inch needle, with two levels, folding sights and staff mountings, see page 142... \$100.00		
276	Pocket Solar Compass, with light tripod.....	105.00	
277	Pocket Solar Compass, with light extension tripod..	110.00	
278	Pocket Solar Compass, with light extension tripod, and leveling-head with clamp and tangent.....	120.00	
280	Side Telescope and Counterpoise fitted to new Pocket Solar Compass	25.00	

POCKET RAILROAD COMPASSES

285	Pocket Railroad Compass, one vernier to limb, limb 5 inches diameter reading to one minute, and with clamp and tangent, 3½-inch needle, folding sights, two levels and staff mountings, see page 145.....	\$40.00	
288	Pocket Railroad Compass, one vernier to limb with clamp and tangent, limb inside the compass circle and reading to 1 minute, 4½-inch needle, folding sights, two levels and staff mountings	33.00	
291	Pocket Railroad Compass, 4½-inch needle, clamp and tangent to limb, limb reading to 1 minute, clamp and tangent to spindle, and fitted with our Telescopic Sight No. 261, with extras of level, vertical circle to 5 minutes, and clamp and tangent to telescope axis, and with tripod.....	76.00	

POCKET RAILROAD COMPASSES

No.		PRICE	Post.
292	Pocket Railroad Compass, same as No. 291, but with Telescope No. 262.....	\$78.00	
293	Pocket Railroad Compass, same as No. 292, and with Leveling-Adopter, complete as shown on page 147.....	83.00	

POCKET VERNIER COMPASSES

300	Pocket Vernier Compass, $3\frac{1}{2}$ -inch needle, folding sights, two levels and staff mountings, see page 149	\$16.00	\$0.70
305	Pocket Vernier Compass, $4\frac{1}{2}$ -inch needle, folding sights, two levels and staff mountings, see page 149	18.00	1.10
311	Pocket Vernier Compass, $4\frac{1}{2}$ -inch needle, clamp and tangent to spindle, and fitted with our Telescopic Sight No. 261, with extras of level, vertical circle to 5 minutes, and clamp and tangent to telescope axis, and with tripod.....	61.00	
312	Pocket Vernier Compass, same as No. 311, but with Telescope No. 262, see page 151.....	63.00	

POCKET PLAIN COMPASSES

315	Pocket Plain Compass, $2\frac{1}{2}$ -inch needle and folding sights.....	\$ 8.00	\$0.25
316	Pocket Plain Compass, $2\frac{1}{2}$ -inch needle, folding sights and staff mountings, see page 152.....	10.00	.35
317	Pocket Plain Compass, $3\frac{1}{2}$ -inch needle and folding sights.....	10.00	.40
318	Pocket Plain Compass, $3\frac{1}{2}$ -inch needle, folding sights and staff mountings, see page 152.....	12.00	.50
319	Pocket Plain Compass, $3\frac{1}{2}$ -inch needle, folding sights, two levels and staff mountings.....	13.50	.50

EXTRAS FOR POCKET COMPASSES

325	Clamp and Tangent fitted to ball-spindle of Compasses Nos. 285, 288, 300, 305, and 315 to 319 ..	\$ 5.00	
326	Rack and Pinion to variation arc of Compasses Nos. 288 to 312.....	4.00	
327	Leveling-Adopter, small size, see page 152.....	5.00	\$0.25
328	Leveling-Head with plates, leveling-screws and clamp and tangent to spindle	10.00	

For Tripods, see pages 186 to 189 and 281. For Leather Cases, see pages 190 and 282.

GEOLOGISTS' AND CLINOMETER COMPASSES

No.		PRICE	POST.
335	Geologists' Compass (of aluminum), graduated movable sighting-circle, graduated base, variation arc, folding sights, two levels, clinometer and staff mountings, see page 153.....	\$24.00	\$0.35
338	Clinometer Compass (of brass), 3½-inch needle, folding sights, square base, two levels, clinometer and staff mountings, see page 154.....	16.00	.50

A small light tripod for these compasses costs extra \$5.00.

MINERS' COMPASSES OR DIPPING-NEEDLES

FOR TRACING VEINS OF MAGNETIC IRON ORE

340	Miners' Dip-Compass, 3-inch needle with stop, glass on both sides, in wood case, see page 156.....	\$16.00	\$0.25
341	Miners' Dip-Compass, 3-inch needle with stop, glass on both sides, with brass covers.....	16.00	.35
344	Miners' Dip-Compass, 3-inch Norwegian needle with stop, glass on both sides, with brass covers, see page 156.....	16.00	.35
345	Miners' Dip-Compass, 4-inch Norwegian needle with stop, glass on both sides, with brass covers.....	20.00	.50

DIAL COMPASSES

348	Brass Dial Compass, with hour circle graduated for any latitude as ordered, variation arc, graduated base, one folding sight, two levels and clinometer, see page 158.....	\$18.00	\$0.40
349	Dial Compass, same as No. 348, and with staff mountings complete.....	20.50	.50
350	Aluminum Dial Compass, with hour circle graduated for any latitude as ordered, graduated base, graduated movable sighting-circle, variation arc, one folding sight, one removable sight, two levels, clinometer and staff mountings, see page 160.....	30.00	.45
	Extra Hour Circles, graduated for any latitude as ordered, to fit either of these Dial Compasses, each.....	5.00	.12

A light tripod for Dial Compasses Nos. 349 and 350 costs extra \$5.00.

LEVELING-INSTRUMENTS

ENGINEERS' Y LEVELS

No.		PRICE
375	Y Level, 22-inch telescope, with leveling-screws, clamp and tangent and tripod.....	\$115.00
376	Y Level, 20-inch telescope, with leveling-screws, clamp and tangent and tripod, see page 163	110.00
377	Y Level, 18-inch telescope, with leveling-screws, clamp and tangent and tripod	110.00
378	Y Level, 15-inch telescope, with leveling-screws, clamp and tangent and tripod, see page 176	90.00

ARCHITECTS' Y LEVELS

380	Architects' Level, 12-inch telescope, with leveling-screws and tripod, see page 177.....	\$50.00
381	Architects' Level, 12-inch telescope, with leveling-screws, clamp and tangent and tripod, see page 178.....	65.00

A compass, without sights and with 3-inch needle, can be attached to the telescopes of these leveling-instruments, Nos. 375 to 381, and used to obtain the bearing of lines when desired; its extra cost is \$10.00. Stadia wires are furnished with any of our Y Levels, free of charge, if requested when the instrument is ordered.

DRAINAGE LEVELS

385	Drainage Level, with staff mountings	\$15.00
386	Drainage Level, with staff mountings and tripod	20.00
387	Drainage Level, with staff mountings, leveling-screws and tripod, see page 182.....	25.00
388	Drainage Level, same as No. 387, and with compass attached, see page 183.....	30.00

All our Levels, Nos. 375 to 388, are packed in mahogany case with lock, and strap or handle. For Level Tripods, see pages 186 to 189, and 281. For Leather Cases, see pages 190 and 282.

TRANSIT TRIPODS

400	Plain Tripod for Transits Nos. 1 to 90, see page 187	\$10.00
401	Plain Tripod for Transits Nos. 100 to 117.....	5.00
405	Split-Leg Tripod for Transits Nos. 1 to 90, see page 188..	12.00
406	Split-Leg Tripod for Transits Nos. 100 to 117.....	10.00
410	Extension Tripod for Transits Nos. 1 to 90, see page 189..	15.00
411	Extension Tripod for Transits Nos. 100 to 117	12.00

COMPASS TRIPODS

No.		PRICE
415	Plain Tripod for Compasses Nos. 210 to 232, see page 187.	\$ 5.00
416	Plain Tripod for Pocket Compasses Nos. 275 to 319.....	5.00
420	Split-Leg Tripod for Compasses Nos. 210 to 232	10.00
421	Split-Leg Tripod for Pocket Compasses Nos. 275 to 319...	8.00
425	Extension Tripod for Compasses Nos. 210 to 232.....	12.00
426	Extension Tripod for Pocket Compasses Nos. 275 to 319...	10.00

LEVEL TRIPODS

430	Plain Tripod for Levels Nos. 375 to 378, see page 187	\$10.00
431	Plain Tripod for Levels Nos. 380 to 388	5.00
435	Split-Leg Tripod for Levels Nos. 375 to 378, see page 188.	12.00
436	Split-Leg Tripod for Levels Nos. 380 to 388.....	10.00
440	Extension Tripod for Levels Nos. 375 to 378, see page 189.	15.00
441	Extension Tripod for Levels Nos. 380 and 381.....	12.00
442	Extension Tripod for Levels Nos. 385 to 388	10.00

When ordering a separate tripod, the customer should always specify for what instrument it is wanted.

BRASS PLUMMETS. Plain

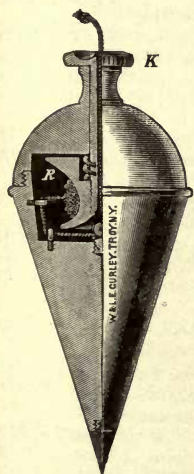

No.		PRICE	POST.
450	Plummet, screw head, steel point, 6 oz.....	\$1.00	\$0.15
452	Plummet, screw head, steel point, 10 oz.....	1.50	.20
454	Plummet, screw head, steel point, 16 oz.....	2.00	.25
456	Plummet, screw head, steel point, 24 oz.....	2.75	.35
458	Plummet, screw head, steel point, 32 oz.....	3.50	.45
460	Plummet, screw head, steel point, long neck, 12 oz....	2.00	.25

BRASS PLUMMETS. Adjustable

These Plummetts have a concealed reel, R, around which the string is wound by turning the milled head, K, on top. The friction upon the reel will hold the Plummett at any desired point of the line.

465	Adjustable Plummett, 10 oz...	\$2.50	\$0.20
469	Adjustable Plummett, 30 oz...	5.00	.45

No.		PRICE	POST.
472	Stake Tacks, galvanized, 2 oz. box	\$0.15	\$0.04
473	Stake Tacks, galvanized, 1 lb. box60	.20
474	Plummet Cord, braided linen, per 25 yards38	.04

SOLE-LEATHER CASES

TO FIT OUTSIDE THE WOOD BOX

		PRICE	
475	Leather Case and Strap, for Engineers' or Surveyors' Transits, price according to size.....	\$8.00 to \$10.00	
476	Leather Case and Strap, for Mountain, Reconnoissance or Builders' Transits.....	8.00	
477	Leather Case and Strap, for Large Solar Compasses	10.00	
478	Leather Case and Strap, for Surveyors' Compasses, Nos. 215 to 232, price according to size.....	6.00 to	9.00
479	Leather Case and Strap, for Engineers' Y Levels, price according to size.....	8.00 to	10.00
480	Leather Case and Strap, for Architects' Levels.....	6.00	
481	Leather Case and Strap, for Drainage Levels	4.00	

LEATHER CASE AND SHOULDER STRAP FOR POCKET COMPASSES, to fit outside the wooden box, see page 190, sizes as follows :

		PRICE	POST.
485	Size for Compasses Nos. 315, 316, 335, 340 to 344, 348 to 350	\$2.50	\$0.20
486	Size for Compasses Nos. 300, 317 to 319, 338, 345,	3.00	.30
487	Size for Compasses Nos. 275, 285, 288, 305.....	4.00	.50
488	Size for Compasses Nos. 291 to 293, 311, 312	6.00	

LEATHER POUCH AND SHOULDER STRAP, fitted to receive Pocket Compasses without the wooden box, see page 190, sizes as follows :

490	Size for Compasses Nos. 315, 316, 335, 340 to 344, 348 to 350	\$2.00	\$0.15
491	Size for Compasses Nos. 300, 317 to 319, 338, 345.	2.50	.25
492	Size for Compasses Nos. 288, 305.....	3.00	.35

TRIPOD CASES

494	Leather Case, with cap and carrying handle, for extension tripod.....	\$10.00	
497	Canvass Case, with leather trimmings, for extension tripod	7.50	

We are prepared to make to order Leather Cases and Pouches of any style and size that may be desired. See page 190.

LEVELING-RODS. SEE PAGES 191 TO 203

No.		PRICE
500	Philadelphia Rod, 2 ply, $7\frac{3}{10}$ feet closed, sliding to 13 feet, graduated to feet, 10ths and 100ths, with vernier reading to 1000ths.....	\$14.00
500B	Philadelphia Rod, 2 ply, $7\frac{3}{10}$ feet closed, sliding to 13 feet, graduated to feet and 10ths, with both target and rod reading by natural scales to half-hundredths.....	14.00
501	Philadelphia Rod, 3 ply, $5\frac{3}{10}$ feet closed, sliding to 13 feet, graduated to feet, 10ths and 100ths, with vernier reading to 1000ths ..	18.00
501B	Special Self-reading Rod, 3 ply, $7\frac{6}{10}$ feet closed, sliding to 20 feet, graduated on four faces to feet and 10ths, and on back of the front section to feet, 10ths and 100ths; also reading by two scales to half-hundredths. With aluminum target and canvas case.....	20.00
502A	Philadelphia Mining Rod, 2 ply, $3\frac{3}{10}$ feet closed, sliding to 5 feet, graduated to feet, 10ths and 100ths, with vernier reading to 1000ths.....	12.00
503	Boston Rod, 2 ply, 6 feet closed, sliding to 11 feet, graduated to feet, 10ths and 100ths, with vernier reading to 1000ths.....	14.00
504	Troy Rod, 2 ply, $6\frac{1}{2}$ feet closed, sliding to 12 feet, graduated to feet, 10ths and 100ths, with vernier reading to 1000ths	10.00
505	New York Rod, 2 ply, $6\frac{8}{10}$ feet closed, sliding to 12 feet, graduated to feet, 10ths and 100ths, with vernier reading to 1000ths.....	14.00
507	New York Rod, 3 ply, 5 feet closed, sliding to $12\frac{1}{2}$ feet, graduated to feet, 10ths and 100ths, with vernier reading to 1000ths.....	18.00
509	New York Mining Rod, 2 ply, $3\frac{3}{10}$ feet closed, sliding to $5\frac{3}{10}$ feet, graduated to feet, 10ths and 100ths, with vernier reading to 1000ths	12.00
510	Architects' Rod, 2 ply, $5\frac{1}{2}$ feet closed, sliding to 10 feet, graduated to feet, inches and 16ths.....	6.00
511	Architects' Rod, 2 ply, $5\frac{1}{2}$ feet closed, sliding to 10 feet, graduated to feet, 10ths and 100ths, with vernier reading to 1000ths	6.00
512	Machinists' Rod, one piece, $6\frac{1}{2}$ feet long, for leveling shafting, graduated to feet, inches and 16ths.....	5.00
513	Telemeter or Stadia Rod, without target, hinge joint, 6 feet folded, unfolding to 12 feet, graduated to feet, 10ths and 100ths	12.00
514	Telemeter or Stadia Rod, without target, hinge joint, 7 feet folded, unfolding to 14 feet, graduated to feet, 10ths and 100ths.....	13.00

LEVELING-RODS

No.		PRICE
515	Telescopic Rod, 3 ply, without target, 5 feet closed, sliding to 14 feet, graduated to feet, 10ths and 100ths.....	\$22.00
516	Cross Section Rod, one piece, without target, 10 feet long, with level vial at each end, graduated to feet, 10ths and 100ths.....	10.00
518A	Plain Rod, one piece, without target, 10 feet long, graduated to feet, 10ths and 100ths.....	6.00
518B	Plain Rod, without target, with hinge joint, 5 feet folded, unfolding to 10 feet, graduated to feet, 10ths and 100ths,	8.00
519A	Plain Rod, one piece, without target, 12 feet long, graduated to feet, 10ths and 100ths.....	7.00
519B	Plain Rod, without target, with hinge joint, 6 feet folded, unfolding to 12 feet, graduated to feet, 10ths and 100ths.	9.00
520A	Plain Rod, one piece, without target, 14 feet long, graduated to feet, 10ths and 100ths.....	8.00
520B	Plain Rod, without target, with hinge joint, 7 feet folded, unfolding to 14 feet, graduated to feet, 10ths and 100ths.	10.00
521B	Plain Rod, without target, with hinge joint, 8 feet folded, unfolding to 16 feet, graduated to feet, 10ths and 100ths.	11.00
522A	Plain Rod, 2 ply, without target, $5\frac{3}{10}$ feet long, sliding to 10 feet, graduated to feet, 10ths and 100ths.....	8.00
522B	Plain Rod, 2 ply, without target, $6\frac{3}{10}$ feet long, sliding to 12 feet, graduated to feet, 10ths and 100ths.....	9.00
522C	Plain Rod, 2 ply, without target, $7\frac{3}{10}$ feet long, sliding to 14 feet, graduated to feet, 10ths and 100ths.....	10.00
524A	Plain Rod, 4 ply, without target, $3\frac{3}{10}$ feet long, sliding to $11\frac{2}{10}$ feet, graduated to feet, 10ths and 100ths.....	10.00

Any of our Leveling-Rods made with metric graduations without extra charge.

Canvas Case for regular pattern Philadelphia or New York Rod, \$3.00; other sizes and styles made to order.

FLEXIBLE OR POCKET LEVELING-RODS

Made of canvas, can be coiled up and carried in pocket. In use it is fastened to a board with thumb tacks.



No.		PRICE	POST.
525A	Pocket Rod, 8 feet long, graduated to feet, 10ths and 100ths	\$3.00	\$0.22
525B	Pocket Rod, 10 feet long, graduated to feet, 10ths and 100ths	3.25	.25
526A	Pocket Rod, 12 feet long, graduated to feet, 10ths and 100ths	4.00	.28
526B	Pocket Rod, 12 feet long, graduated to feet, inches and 8ths	4.00	.28
527	Pocket Rod, 14 feet long, graduated to feet, 10ths and 100ths	4.50	.30
528*	Pocket Rod, 3½ meters long, graduated to centimeters	4.00	.30

COMBINED LEVELING-POLE AND FLAGSTAFF

		PRICE
530	Wood Leveling-Pole and Staff, 7 feet long, see page 202...	\$5.00
531	Wood Leveling-Pole and Staff, 9 feet long	6.00

WOOD AND IRON FLAGSTAFFS. SEE PAGE 203

These staffs are divided in feet, which are painted alternately red and white.

534	Wood Staff, 6 feet long, with metal shoe.....	\$2.00
535	Wood Staff, 8 feet long, with metal shoe	2.25
536	Wood Staff, 10 feet long, with metal shoe.....	2.50

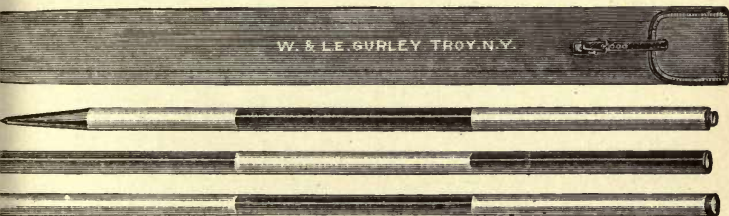

537A TO 538B

537A	Wood Staff, round, 6 feet long, with one screw-joint.....	4.50
537B	Wood Staff, round, 6 feet long, with one screw-joint and with canvas case	7.00
538A	Wood Staff, round, 9 feet long, with two screw-joints.....	7.50
538B	Wood Staff, round, 9 feet long, with two screw-joints and with canvas case	10.50

No.		PRICE
539	Aligning or Ranging-Pole, 6 feet long, hung in gimbals...	\$4.00

The aligning-pole consists of an iron tube, $\frac{1}{8}$ of an inch diameter, 6 feet long, and being hung in gimbals always assumes a vertical position.

541	Iron Tubular Ranging-Pole, 6 feet long, $\frac{1}{16}$ inch diameter.	2.75
543	Iron Tubular Ranging-Pole, 8 feet long, $\frac{1}{8}$ inch diameter.	3.00
544	Iron Tubular Ranging-Pole, 10 feet long, $\frac{1}{8}$ inch diameter.	3.50

Any of the above staffs and poles with metric graduations (five to a meter) at same price.

		PRICE	POST.
545	Rod Level, for plumbing a Rod or Staff, see page 204.....	\$3.00	\$0.15
546	Circular Rod Level, with folding joint, see page 204	3.00	.15

PLANE-TABLE OUTFITS

No.		PRICE
549	Plane-Table, with board 30 x 24 inches, mounted on large tripod with leveling-socket and clamp, and with plumb-ing-arm, plummet and clamps for paper.....	\$45.00
	Set of three leveling-screws, No. 563.....	10.00
	Clamp and tangent, for orienting, No. 564.....	10.00
	Combined Compass with levels and square base.....	15.00
	Alidade with telescope 11 inches long, with stadia, 4½-inch vertical circle to 1 minute, level on telescope and clamp and tangent, on column, power of telescope 24 diameters, see page 213, No. 583.....	90.00
	Total, as shown on page 208.....	<u>\$170.00</u>
550	Plane-Table, with board, tripod, etc., as in No. 549.....	\$45.00
	Combined Compass with levels and square base.....	15.00
	Alidade with telescope 11 inches long, with stadia, 4½-inch vertical circle to 1 minute, level on telescope and clamp and tangent, on column, power of telescope 24 diameters, see page 213, No. 583.....	90.00
	Total.....	<u>\$150.00</u>
553	Plane-Table, with board, tripod, etc., as in No. 549.....	\$45.00
	Combined Compass with levels and square base.....	15.00
	Alidade with telescope 9 inches long, power 20 diameters, with stadia, vertical circle to 1 minute, level on telescope and clamp and tangent, on column, see pages 205 and 213, No. 582.....	70.00
	Total, as shown on page 205.....	<u>\$130.00</u>
556	Plane-Table, with board, tripod, etc., as in No. 549.....	\$45.00
	Combined Compass with levels and square base.....	15.00
	Alidade with telescopic sight No. 262, with stadia, vertical circle to 5 minutes, level and clamp and tangent, see page 212, No. 581.....	50.00
	Total.....	<u>\$110.00</u>
559	Plane-Table, with board, tripod, etc., as in No. 549.....	\$45.00
	Combined Compass with levels and square base.....	15.00
	Alidade with sight vanes, see page 212, No. 580.....	15.00
	Total.....	<u>\$75.00</u>
560	Plane-Table, with board, tripod, etc., as in No. 549, and omitting Compass and Alidade.....	\$45.00
563	Set of three leveling-screws for Plane-Tables Nos. 550 to 560, extra.....	10.00
564	Clamp and tangent, for orienting, for Plane-Tables Nos. 550 to 560, extra.....	10.00

JOHNSON IMPROVED PLANE-TABLE AND EXTRAS

Prices for separate parts. See engraving, page 211.

No.		PRICE
570	Johnson Plane-Table Movement and plain tripod	\$35.00
	If tripod has extension legs, the extra cost is \$10.00.	
573	Drawing Board, 31 x 24 inches, with brass screw-plate fitted, and with eight clamp screws and sockets for paper	5.00
	Canvas-covered wooden case for No. 573	6.00
	Flexible canvas case for No. 573	2.00
574	Plumbing-arm and plummet	4.00
575	Combined Compass with levels and square base	15.00

JOHNSON PLANE-TABLE OUTFITS

576	Johnson Plane-Table Movement and tripod, with drawing- board, 31 x 24 inches, with brass screw-plate fitted, and with eight clamp screws and sockets for paper	\$40.00
	Plumbing-arm and plummet	4.00
	Combined Compass with levels and square base	15.00
	Alidade with telescope 11 inches long, with stadia, $4\frac{1}{2}$ -inch vertical circle to 1 minute, level on telescope and clamp and tangent, on column, power of telescope 24 diameters, see page 213, No. 583	90.00
	Total, as shown on page 211	\$149.00
577	Plane-Table, with tripod, board, etc., as in No. 576	\$40.00
	Plumbing-arm and plummet	4.00
	Combined Compass with levels and square base	15.00
	Alidade with telescope 9 inches long, power 20 diameters, with stadia, vertical circle to 1 minute, level on telescope and clamp and tangent, on column, No. 582	70.00
	Total	\$129.00
578	Plane-Table, with tripod, board, etc., as in No. 576	\$40.00
	Plumbing-arm and plummet	4.00
	Combined Compass with levels and square base	15.00
	Alidade with telescopic sight No. 262, with stadia, vertical circle to 5 minutes, level and clamp and tangent, see page 212, No. 581	50.00
	Total	\$109.00
579	Plane-Table, with tripod, board, etc., as in No. 576	\$40.00
	Plumbing-arm and plummet	4.00
	Combined Compass with levels and square base	15.00
	Alidade with sight vanes, see page 212, No. 580	15.00
	Total	\$74.00

ALIDADES

No.		PRICE
580	Alidade with Compass sights, see page 212.....	\$15.00
581	Alidade with telescopic sight No. 262, with stadia, vertical circle to 5 minutes, level and clamp and tangent, see page 212.....	50.00
582	Alidade with telescope 9 inches long, power 20 diameters, with stadia, vertical circle to 1 minute, level on telescope and clamp and tangent, on column, as in engraving, see pages 205 and 213.....	70.00
583	Alidade with telescope 11 inches long, with stadia, 4½-inch vertical circle to 1 minute, level on telescope and clamp and tangent, on column, power of telescope 24 diameters, see page 213.....	90.00
584A	Alidade with telescope 11 inches long, with inverting eyepiece, stadia, vertical arc to 1 minute, detachable striding-level, axis tangent, diagonal prism for eyepiece. The telescope has a power of 24 diameters, and is mounted on column, see page 214.....	118.00
584B	Alidade same as No. 584A, but with erecting eyepiece....	118.00

The Alidades as above described can be used with any of our Plane-Tables Nos. 549 to 579, and will be sold separately at the prices named.

TRAVERSE PLANE-TABLE—U. S. G. S. PATTERN

586	Improved Traverse Plane-Table Board, 15 x 15 inches, with Box Compass let into one edge, Ruler Alidade with graduated edge, folding sights and leather pouch, tripod of new pattern with plunger clamp and spring board plate, complete as shown on page 215	\$30.00
-----	--	---------

If the tripod has extension legs, add extra \$5.00.

When desired, we furnish separate parts of this Plane-Table at the following prices:

587	Drawing-Board with improved spring board plate, tripod head and plain legs.....	12.00
588	Box Compass, rectangular metal case, 4-inch needle.....	8.00
589	Ruler Alidade, 10 inches long, with graduated edge, folding sights and with leather pouch.....	12.00
590A	Pocket Alidade, 6 inches long, with graduated edge and folding sights, and with leather case with pencil pockets	7.50
590B	Extra folding sights for Alidade No. 590A, per pair.....	3.60
591	Pocket Alidade, 7 inches long, with graduated edge, one peep sight and one folding sight, and with leather case with pencil pockets.....	12.00

Four clamp screws and sockets for board, \$0.75 extra.

BATSON SKETCHING-CASE

No.		PRICE
595	Batson Sketching-Case, as shown and with leather case, see pages 217 to 221	\$30.00
	Wood Staff, about 2 feet long, with steel-pointed shoe, extra.....	1.00
	Plain Tripod, about 3½ feet long, extra.....	3.50

CURRENT METERS

For measuring the velocity of the current of rivers and harbors, at any depth.

600	Current Meter for Harbors and Rivers, see page 224.....	\$80.00
604	Brass Tubing, graduated to feet and tenths, and jointed in 4-ft. lengths, per length	5.00
606	Lead Weight, 60 lbs., with connections, see page 224.....	15.00
609	Electric Register, see pages 224 and 228.....	50.00
612	Wet-Cell Battery of three cells, in box with lock and strap..	7.00
614	Insulated Copper Wire for battery, for use with Meter No. 600, per foot.....	.03
616	Acoustic Current Meter for small streams, see page 231....	50.00
617	Electric Current Meter, indicating every revolution, with Vane and Torpedo Weight, for small streams, complete with electric sounder and twenty feet of cable, see page 233	63.50
	Extra length of cable, per foot 5 cents.	
618	Electric Current Meter, with base, omitting Vane and Lead Weight, for shallow streams, complete with four feet of graduated brass tube, electric sounder and twenty feet of cable, see page 237.....	63.50
619	Time-Recorder, open face, nickel case, stem-winder, with fly-back attachment for starting and stopping. Registering minutes, seconds, and fifths of seconds.....	8.00
621	Electric Current Meter, indicating every fifth revolution, with Vane and Torpedo Weight, for small streams, complete with electric sounder and twenty feet of cable, see page 238	63.50
629	Boyden Hook-Gauge, see page 239	25.00

Water Registers, Tide Gauges, and similar instruments made to order from designs submitted.

HAND LEVELS

		PRICE	POST.
640	Monocular Hand Level, in case, see page 241.....	\$12.00	\$0.20
641	Binocular Hand Level, in case, see page 241.....	15.00	.35
643	Locke Hand Level, nickel-plated, in case, see page 243.....	8.00	.20
646	Abney Level, an improved Locke Hand Level, giving angles of elevation; graduated for slopes, as 1 to 1, 2 to 1, etc., in case, see page 244.....	13.50	.25
648	Abney Level, same as No. 646, with compass and plain staff socket attached.....	18.00	.30

Nos. 640 to 646 are our own make; No. 648 is of foreign make.

CHAINS. SEE PAGES 245 TO 248

No.		PRICE	POST.
650	33 feet, 50 links, oval rings, No. 10 refined iron wire	\$2.25	\$0.65
651	33 feet, 50 links, oval rings, No. 8 refined iron wire	2.50	.85
652	66 feet, 100 links, oval rings, No. 10 refined iron wire	3.50	1.15
653	66 feet, 100 links, oval rings, No. 8 refined iron wire	4.00	1.75
656	33 feet, 50 links, oval rings, No. 10 best steel wire..	4.00	.65
658	50 feet, 50 links, oval rings, No. 10 best steel wire..	4.75	.80
660	66 feet, 100 links, oval rings, No. 10 best steel wire..	7.00	1.15
662	100 feet, 100 links, oval rings, No. 10 best steel wire..	8.50	1.50

BRAZED STEEL CHAINS

670	33 feet, 50 links, No. 12 tempered steel wire, brazed links and rings	\$ 5.00	\$0.45
671	50 feet, 50 links, No. 12 tempered steel wire, brazed links and rings	6.00	.55
672	66 feet, 100 links, No. 12 tempered steel wire, brazed links and rings	9.00	.70
673	100 feet, 100 links, No. 12 tempered steel wire, brazed links and rings.....	10.00	1.00

Our brazed steel chains displace the ordinary chains wherever they are tried, on account of superior lightness and strength. They are practically the only chains now used in railroad construction.

Chains of two and four poles with 40 and 80 links, same price as chains of 50 and 100 links.

Steel snaps to make full chains into half-chains, without extra charge, if ordered with the chain.

GRUMMAN PATENT STEEL CHAINS

680	33 feet, 50 links, No. 15 tempered steel wire, weight 1 lb.....	\$ 5.00	\$0.28
681	50 feet, 100 links, No. 15 tempered steel wire, weight $1\frac{1}{4}$ lbs.....	6.00	.30
682	66 feet, 100 links, No. 15 tempered steel wire, weight $1\frac{1}{2}$ lbs.....	9.00	.35
683	100 feet, 200 links, No. 15 tempered steel wire, weight $2\frac{1}{4}$ lbs.....	11.00	.50
685	50 feet, 100 links, No. 18 tempered steel wire, with spring-balance, level and thermometer, for very accurate measurements, weight $14\frac{1}{2}$ oz.....	15.00	.30
688	Spring-balance for 10 lbs. strain with handle and steel snap, to use with chains Nos. 680 to 683....	2.50	.15

VARA CHAINS

No.		PRICE	Post.
690	10 varas, 50 links, oval rings, No. 10 refined iron wire	\$2.25	\$0.55
691	10 varas, 50 links, oval rings, No. 8 refined iron wire	2.50	.75
694	20 varas, 100 links, oval rings, No. 10 refined iron wire	3.50	1.00
695	20 varas, 100 links, oval rings, No. 8 refined iron wire.....	4.00	1.65
700	10 varas, 50 links, oval rings, No. 10 best steel wire	4.00	.55
704	20 varas, 100 links, oval rings, No. 10 best steel wire.....	7.00	1.00
708	10 varas, 50 links, oval rings, No. 12 tempered steel wire, brazed links and rings.....	5.00	.35
710	20 varas, 100 links, oval rings, No. 12 tempered steel wire, brazed links and rings.....	9.00	.65

METER CHAINS

715	10 meters, 50 links, oval rings, No. 10 refined iron wire	\$2.25	\$0.65
716	10 meters, 50 links, oval rings, No. 8 refined iron wire	2.50	.85
719	20 meters, 100 links, oval rings, No. 10 refined iron wire	3.50	1.15
720	20 meters, 100 links, oval rings, No. 8 refined iron wire	4.00	1.75
723	10 meters, 50 links, oval rings, No. 10 best steel wire	4.00	.65
727	20 meters, 100 links, oval rings, No. 10 best steel wire	7.00	1.15
730	10 meters, 50 links, oval rings, No. 12 tempered steel wire, brazed links and rings.....	5.00	.45
732	20 meters, 100 links, oval rings, No. 12 tempered steel wire, brazed links and rings.....	9.00	70

MARKING-PINS AND TIMBER-SCRIBE

740	Set of 11 Pins, No. 4 iron wire, 14 inches long.....	\$1.25	\$0.50
742	Set of 11 Pins, No. 6 steel wire, 14 inches long.....	1.50	.40
744	Set of 11 Pins, No. 6 steel wire weighted, 14 inches long	2.50	1.25
746	Set of 11 Pins, No. 10 steel wire, 9 inches long, in leather pouch.....	2.00	.25
748	Set of 11 Pins, No. 4 brass wire, 14 inches long.....	2.50	.50
750	Timber-Scribe, for marking trees, posts or boards....	1.00	.15

STEEL RIBBON CHAIN TAPES

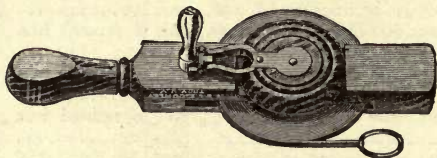
 $\frac{1}{4}$ INCH WIDE, AND WITH HANDLES AND REEL

No.		PRICE	Post.
760	Steel Ribbon, 33 feet, graduated to fifty links only ..	\$3.50	\$0.25
761	Steel Ribbon, 50 feet, graduated each foot.....	4.00	.30
762	Steel Ribbon, 66 feet, graduated to 100 links only...	4.50	.35
763	Steel Ribbon, 100 feet, graduated each foot.....	5.00	.40
764	Steel Ribbon, 100 feet, graduated each foot (heavy ribbon)	6.00	.50
765	Steel Ribbon, 200 feet, graduated each foot up to 100 feet, and the last 100 feet graduated each 10 feet .	7.50	.70
766	Steel Ribbon, 200 feet, graduated each foot (heavy ribbon)	9.00	
767	Steel Ribbon, 300 feet, graduated each foot up to 100 feet, and the last 200 feet graduated each 10 feet.	10.00	
768	Steel Ribbon, 300 feet, graduated each foot (heavy ribbon)	12.00	

The 50, 100, 200, and 300 feet Chain Tapes also have the first and last foot in 10ths.

STEEL RIBBON BRIDGE TAPES

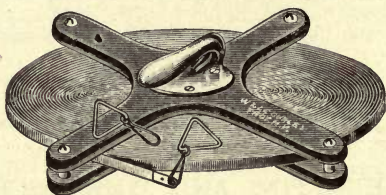
 $\frac{1}{4}$ INCH WIDE, WITH HANDLES AND EXTRA FINE REELS

No.		PRICE
770	Steel Ribbon, 300 feet, graduated each 5 feet.....	\$13.00
771	Steel Ribbon, 400 feet, graduated each 5 feet.....	15.00
772	Steel Ribbon, 500 feet, graduated each 5 feet.....	17.00

Our Bridge Tapes are mounted on substantial wooden reels with aluminum and brass mountings and swivel handle.

These tapes have the first and last 5 feet graduated each foot.

We can also furnish tapes, Nos. 760 to 772, graduated each meter or each vara. See page 251.

Tapes, Nos. 760 to 772, have etched graduations.

METALLIC TAPES

Made of linen thread, interwoven with fine brass wire. They are $\frac{5}{8}$ inch wide, and in leather cases. The graduations are in 10ths or 12ths of a foot, as desired, on one side, and in links on the reverse side.

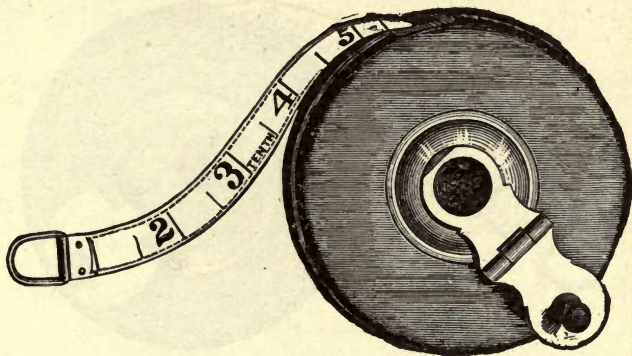

No.		PRICE	POST.
780	Metallic Tape, 33 feet, in 10ths or 12ths, and links..	\$2.10	\$0.18
782	Metallic Tape, 50 feet, in 10ths or 12ths, and links..	2.60	.20
783	Metallic Tape, 66 feet, in 10ths or 12ths, and links..	3.00	.25
786	Metallic Tape, 100 feet, in 10ths or 12ths, and links	4.20	.30

We can furnish metallic tapes with métric or vara measure on reverse side, instead of links, at an extra cost of one cent per foot.

METALLIC TAPES WITHOUT CASES

These tapes can be put into the leather cases when the original tape line is worn out.

790	Metallic Tape, 33 feet, in 10ths or 12ths, and links, without case	\$1.10	\$0.12
791	Metallic Tape, 50 feet, in 10ths or 12ths, and links, without case	1.50	.15
792	Metallic Tape, 66 feet, in 10ths or 12ths, and links, without case	1.80	.18
794	Metallic Tape, 100 feet, in 10ths or 12ths, and links, without case	2.90	.20

STANDARD AMERICAN STEEL TAPES

$\frac{3}{8}$ INCH WIDE, IN LEATHER CASES; THE MOST ACCURATE,
DURABLE AND PORTABLE MEASURES

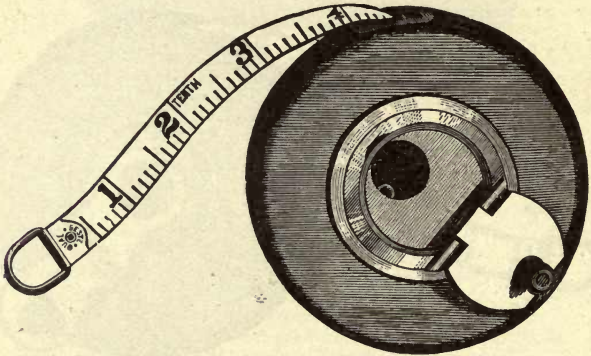

No.						PRICE	POST.
800	Steel Tape,	25 feet,	in 10ths or 12ths,	and links....		\$ 3.75	\$0.15
801	"	"	33 feet,	" " " "		4.30	.18
802	"	"	50 feet,	" " " "		6.00	.20
803	"	"	66 feet,	" " " "		7.60	.23
804	"	"	75 feet,	" " " "		8.60	.25
805	"	"	100 feet,	" " " "		10.60	.30
806	"	"	150 feet,	" " " "		15.50	.45
807	"	"	200 feet,	" " " "		20.00	.60

THE "STAR" STEEL TAPE

$\frac{3}{8}$ INCH WIDE, IN NICKELED BRASS CASES

No.							
808	Steel Tape,	25 feet,	in 10ths or 12ths,	and links....		\$3.00	\$0.15
809	"	"	33 feet,	" " " "		3.20	.18
810	"	"	50 feet,	" " " "		3.60	.20
811	"	"	66 feet,	" " " "		4.40	.25
812	"	"	75 feet,	" " " "		4.80	.30
813	"	"	100 feet,	" " " "		6.40	.35

Steel Tapes, Nos. 800 to 879, have etched graduations.

CHESTERMAN'S ENGLISH STEEL TAPES

$\frac{3}{8}$ INCH WIDE, IN LEATHER CASES, FOLDING HANDLE

No.		PRICE	POST.
815	Steel Tape, 33 feet, in 10ths or 12ths, and links . . .	\$5.20	\$0.18
816	" " 50 feet, " " " " . . .	7.20	.20
817	" " 66 feet, " " " " . . .	9.20	.23
819	" " 100 feet, " " " " . . .	12.80	.30

AMERICAN STEEL TAPES. PAINE'S PATTERN

$\frac{1}{4}$ INCH WIDE, IN LEATHER CASES, FOLDING HANDLES

No.			
820	Steel Tape, 33 feet, in 10ths or 12ths, and links . . .	\$4.40	\$0.18
821	" " 50 feet, " " " " . . .	6.40	.23
822	" " 66 feet, " " " " . . .	8.00	.28
823	" " 75 feet, " " " " . . .	9.60	.30
824	" " 100 feet, " " " " . . .	12.00	.35

AMERICAN STEEL TAPES. PAINE'S PATTERN

$\frac{1}{4}$ INCH WIDE, IN METAL CASES, FOLDING HANDLES

No.			
830	Steel Tape, 25 feet, in 10ths or 12ths, and links . . .	\$2.80	\$0.15
831	" " 33 feet, " " " " . . .	3.60	.18
832	" " 50 feet, " " " " . . .	4.80	.23
833	" " 66 feet, " " " " . . .	6.40	.28
834	" " 75 feet, " " " " . . .	8.00	.30
835	" " 100 feet, " " " " . . .	9.60	.35

Tapes, Nos. 821 to 824, and 832 to 835 (50 to 100 feet), are detachable from their cases, and furnished with an extra handle, No. 841, and can be used as a chain tape.

EXTRAS FOR PAINE'S STEEL TAPES

No.			
840	Compensating Handles, detachable, with graduated scale, per pair	\$2.40	\$0.12
841	Plain Finger-ring Handles, detachable, each40	.02
843	Pocket Thermometers, each85	.15
844	Spring-Balance, with handle and snap	2.50	.15
845	Spring-Balance and Level, with handle and snap	4.00	.15

Tapes, Nos. 800 to 835, are graduated to feet, 10ths and 100ths of a foot, or to feet, inches and 8ths of inches, as desired, on one side, and in links on the reverse side.

Tapes, Nos. 820 to 835, with metric or vara measure on reverse side instead of links, at an extra cost of two and one-half cents per foot.

EXCELSIOR STEEL TAPES

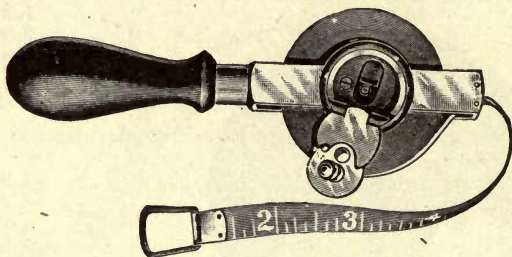
 $\frac{1}{2}$ INCH WIDE, ON BRASS FRAME WITH HANDLE

No.						PRICE	POST.
850	Steel Tape,	33 feet,	in 10ths or 12ths,	and links...		\$ 5.00	\$0.20
851	" "	50 feet,	" "	" " " ...		6.40	.25
852	" "	66 feet,	" "	" " " ...		8.00	.30
853	" "	100 feet,	" "	" " " ...		11.50	.40
854A	" "	150 feet,	" "	" " " ...		17.00	.60
854B	" "	200 feet,	" "	" " " ...		22.00	
855	" "	50 feet,	" "	" meters..		7.65	.25
858	" "	100 feet,	" "	" " ..		14.00	.40
859A	" "	150 feet,	" "	" " ..		20.75	.60
859B	" "	200 feet,	" "	" " ..		27.00	

Tapes Nos 850 to 854B are graduated to feet, 10ths and 100ths of a foot, or to feet, inches and 8ths of inches, as desired, on one side, and in links on the reverse side.

Tapes Nos. 855 and 859B have metric measure on the reverse side instead of links.

METRIC AND VARA TAPES

We can furnish any of our tapes, Nos. 780 to 794 and 820 to 835, with metric or vara measure only, at prices for regular style of tapes of similar lengths in feet. If with metric or vara measure on reverse side, instead of links, the extra cost will be as stated on pages 294 and 296.

NICKEL-PLATED TAPES

When desired, we will nickel-plate our steel tapes, Nos. 800 to 835 and 850 to 859B, to protect from rust, at the following prices :

	25	33	50	66	75	100	150	200	300	500 feet.
Each, \$0.90	1,00	1,50	1,75	1,75	2,00	2,50	3,00	4,00	6,00	

POCKET STEEL TAPES

IN GERMAN SILVER CASES, WITH SPRING AND STOP

No.		PRICE	POST.
860	Pocket Steel Tape, 3 feet, in 10ths or 12ths.....	\$1.00	\$0.11
863	“ “ “ 6 feet, “ “	1.40	.12
866	“ “ “ 12 feet, “ “	2.50	.15
870	Pocket Steel Tape, 6 feet, in 10ths one side and 12ths reverse side.....	1.60	.12
873	Pocket Steel Tape, 12 feet, in 10ths one side and 12ths reverse side.....	2.80	.15
875	Pocket Steel Tape, 3 feet, in 10ths or 12ths, and meter	1.10	.11
877	Pocket Steel Tape, 6 feet, in 10ths or 12ths, and meter.. ..	1.60	.12
879	Pocket Steel Tape, 12 feet, in 10ths or 12ths, and meter.....	2.80	.15

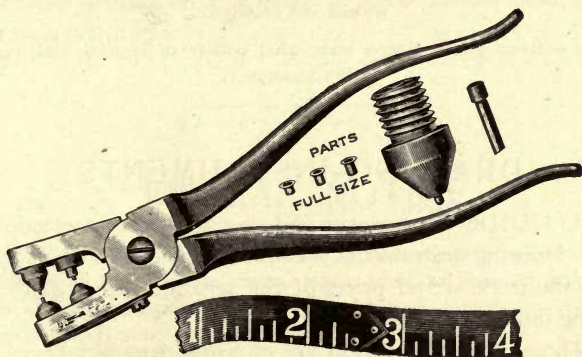

885

PUNCH AND RIVETER, FOR REPAIRING TAPE-LINES

This punch cuts a clean hole in steel tapes of the usual thickness, and the eyelet is then inserted and quickly and neatly riveted. The Punch is $7\frac{3}{4}$ inches long.

No.		PRICE	POST.
885	Punch and Riveter, with eyelets.....	\$5.00	\$0.30
886	Extra eyelets, two lengths, two packages of 500 each length.....	1.25	.05

SUPPLEMENT

TO

Forty-second Edition of Manual

August, 1908

The prices in this Catalogue may vary from time to time, on account of fluctuations in Market Rates.

This Price List supersedes all previous editions, and has been carefully revised and enlarged.

When ordering goods always state what edition of Manual, and number in Catalogue.

DRAWING-INSTRUMENTS

TO GUIDE the surveyor and engineer in the selection of Drawing-Instruments, we here add a detailed description, with illustrations and prices of the separate pieces and cases of the different kinds in general use.

Those we first mention are of Swiss manufacture, of the finest quality and finish, and are made of the best German silver and English steel.

We show first the regular patterns and then those with the celebrated pivot-joint.

The Alteneder instruments are the best of American manufacture, and are equally as good as those of Swiss make.

The fine German silver instruments, of German make, are the best of their kind.

The instruments before mentioned are intended for engineers, architects, draftsmen, machinists and students in technical schools.

The cheaper German silver, brass and nickel-plated instruments are for common school use and elementary practice.

Parties wanting special cases made up can select the pieces and we will make cases to suit, at an additional cost of from \$2 to \$10, according to the size and quality of the cases, which are made of morocco, rosewood or mahogany.

For prices of regular size cases, see page 310.

For the convenience of our customers, we will furnish any articles not on our list, but described in the catalogue of any American manufacturer or dealer in mathematical instruments, at catalogue prices.

SPECIAL NOTICE

MANY of our smaller instruments, such as drawing-instruments, pocket compasses, chains, tapes, small packages of paper and parts of large instruments, can be sent by mail securely packed, and at much lower rates than are charged by express companies. Packages not exceeding four pounds in weight can be sent in this way within the United States, Canada and Mexico at a cost of one cent per ounce.

In all cases where goods are to be sent by mail, the cash for postage as well as for the goods must accompany the order.

The postage required is mentioned in the second column of the Price List, and for articles worth more than one dollar the amount named for postage includes the cost of registry.

All articles can be registered at an extra cost of eight cents for each package besides regular postage. Packages for registry should not exceed four feet in length.

We are not responsible for goods lost or injured when sent by mail.

SUPERIOR SWISS DRAWING-INSTRUMENTS
OF GERMAN SILVER, EXTRA FINE FINISH

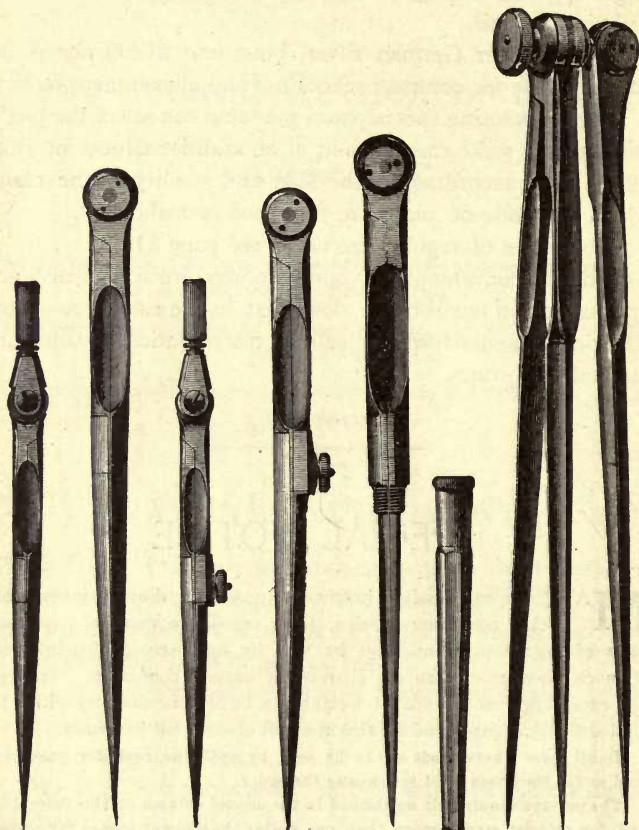

No.		PRICE	Post.
1000	Plain Dividers, 3½-inch, with handle.....	\$1.50	\$0.10
1002	Plain Dividers, 4½-inch, without handle.....	1.50	.12
1003	Plain Dividers, 5-inch, without handle.....	1.75	.12
1005	Hairspring Dividers, 3½-inch, with handle.....	2.25	.10

No.		PRICE	POST.
1007	Hairspring Dividers, 4½-inch, without handle	\$2.25	\$0.12
1008	Hairspring Dividers, 5-inch, without handle	2.50	.12
1010	Pocket Dividers, 5-inch, with sheath	2.50	.12
1011	Three-legged Dividers, 6-inch, for spacing off three points	4.00	.13
1013	Whole and Half Dividers, 7¼-inch	3.50	.15

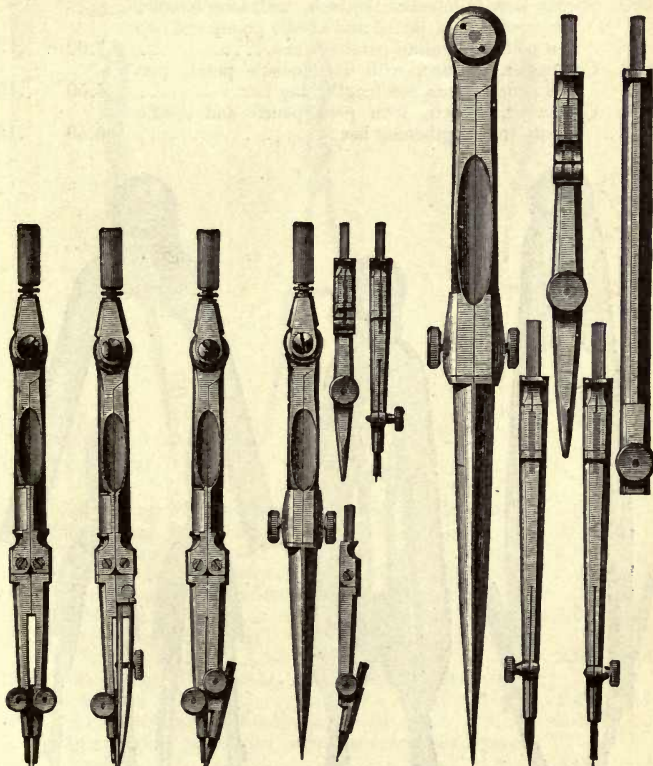

1015	Compasses, 3½-inch, with two fixed needle points . .	3.00	.10
1016	Compasses, 3½-inch, with fixed needle and pen points	3.00	.10

No.		PRICE	Post.
1017	Compasses, $3\frac{1}{2}$ -inch, with fixed needle and pencil points ..	\$3.00	\$0.10
1018	Compasses, $3\frac{1}{2}$ -inch, with fixed needle point, and pen and pencil points.....	4.50	.12
1019	Compasses, $3\frac{1}{2}$ -inch, with pen, pencil and needle points ..	5.00	.12
1020	Spring Bow-Compasses, $3\frac{1}{2}$ -inch, with long handle, two steel points, pencil and needle points and two pen points for ruling parallel lines.....	7.00	.13
1022	Compasses, $5\frac{1}{2}$ -inch, with fixed needle point, pen and pencil points and lengthening bar.....	5.50	.15
1024	Compasses, 6-inch, with pen, pencil and needle points and lengthening bar	6.50	.15

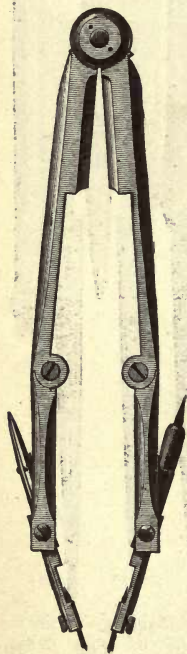

1028

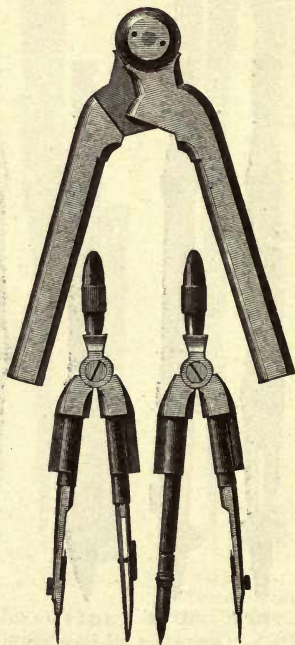
 Folded
1029

 Drawn out for small circles
1029

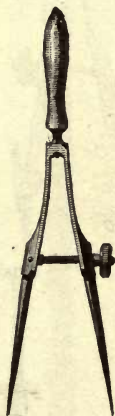
No.		PRICE	POST
1026	Compasses, 6½-inch, with joint in each leg, pen, pencil, and needle points, dotting-pen and lengthening bar.....	\$9.00	\$0.18
1028	Pocket-Compasses, with folding points.....	8.75	.12
1029	Pillar-Compasses, with handles, pen, pencil, and two needle points which can be drawn out and used as a small bow-pen and bow-pencil.....	9.75	.14



1033



1034



1035

1033	Steelspring Bow-dividers, with ivory handle, 3-inch,	1.50	.10
1034	Steelspring Bow-pen, with ivory handle, 3-inch....	2.00	.10
1035	Steelspring Bow-pencil, with ivory handle, 3-inch..	2.00	.10
1039	Steelspring Bow-dividers, with ivory handle, 3½-inch..	2.00	.10
1040	Steelspring Bow-dividers, with needle point, ivory handle, 3½-inch.....	2.50	.10
1041	Steelspring Bow-pen, with needle point, ivory handle, 3½-inch.....	2.50	.10
1042	Steelspring Bow-pencil, with needle point, ivory handle, 3½-inch.....	2.50	.10
1046	Spring Bow-pen, with adjusting-screw.....	2.00	.10
1047	Spring Bow-pen, with adjusting-screw and pencil point.....	3.00	.10
1048	Spring Bow-pen, with adjustable point, for small circles.....	3.00	.10
1049	Spring Bow-pen and pencil, with adjustable point, for small circles.....	4.00	.10

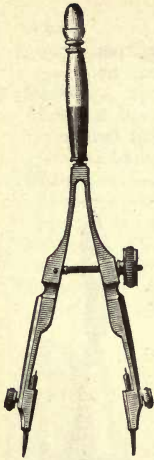

1040

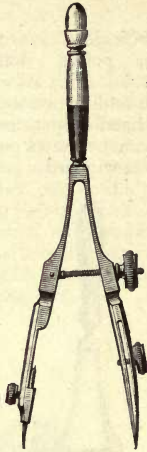

1041

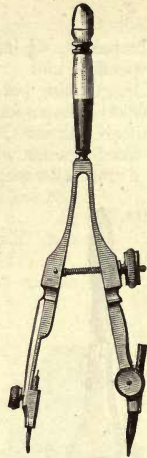

1042



1046

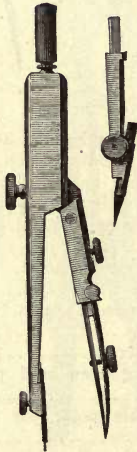

1047



1048



1049

For prices, see page 305.

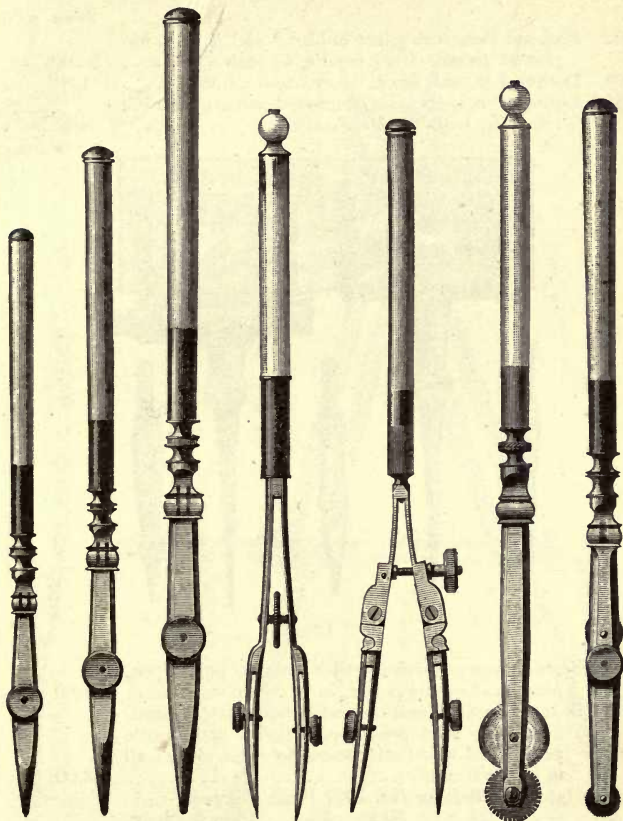

No.		PRICE	POST.
1055	Drawing-Pen, with joint and pin, ivory handle, 4 $\frac{3}{4}$ -inch	\$1.25	\$0.10
1056	Drawing-Pen, with joint and pin, ivory handle, 5 $\frac{1}{2}$ -inch	1.40	.10
1057	Drawing-Pen, with joint and pin, ivory handle, 6 $\frac{1}{2}$ -inch	1.60	.10
1060	Railroad Pen, without joints, ivory handle, 6-inch..	2.50	.10

No.		PRICE	POST.
1062	Railroad Pen, with joints in blades and shanks, improved pattern, ivory handle, 5½-inch.....	\$3.00	\$0.10
1064	Dotting-Pen, one wheel, ivory handle, 6-inch.....	1.85	.10
1065	Dotting-Pen, six wheels, improved pattern, with ink reservoir, ivory handle, 6-inch.....	3.75	.10

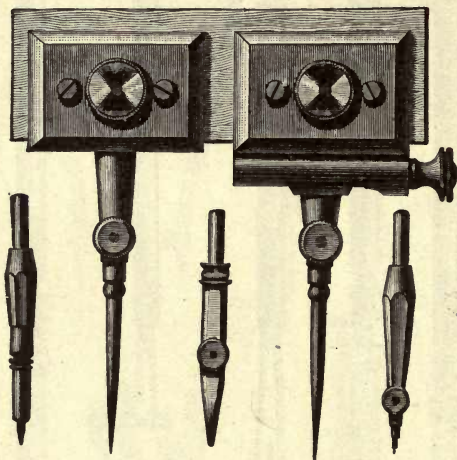

1067

1067	Beam-Compass Furniture, with two steel points, pen, pencil and needle points, in morocco case.....	8.00	.20
1068	Beam-Compass Furniture, with micrometer adjustment, two steel points, pen, pencil and needle points, and wheel attachment to stand alone; all in morocco case.....	13.00	.30
1069	Hardwood Bars for No. 1067 Beam-Compass, 24 30 36 48 inches long. Each, \$0.25 \$0.30 \$0.35 \$0.50 Postage, .10 .12 .15 .20		
1070	Beam-Compasses, 18-inch, in two German silver bars, with two steel points, pen, pencil and needle points.....	10.50	.20
1071	Beam-Compasses, 24-inch, three bars, with two steel points, pen, pencil and needle points.....	11.75	.25
1072	Beam-Compasses, 36-inch, three bars, with two steel points, pen, pencil and needle points.....	15.25	.30

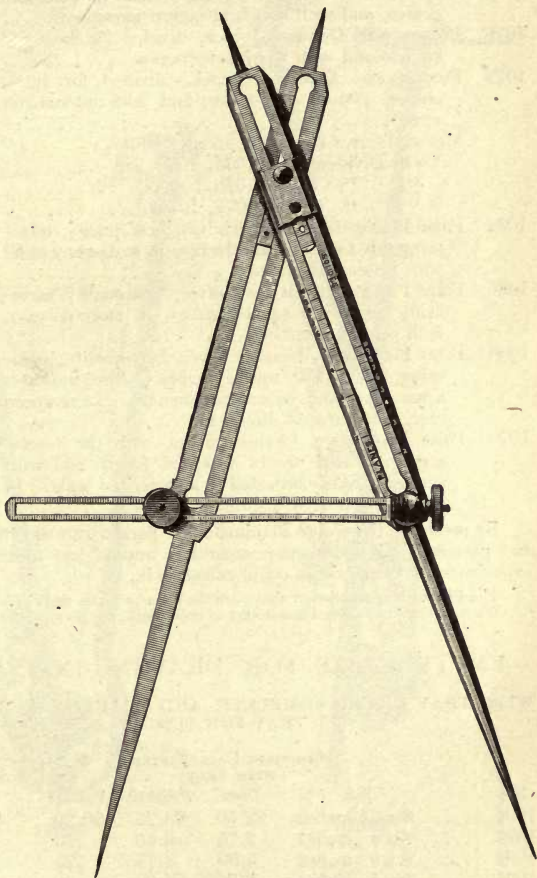

1075

1079

No.		PRICE	POST.
1074	Proportional Dividers, $7\frac{1}{8}$ -inch, divided for lines . . .	\$8.00	\$0.15
1075	Proportional Dividers, $7\frac{1}{8}$ -inch, divided for lines and circles	9.00	.15

No.		PRICE	POST.
1076	Proportional Dividers, 8 $\frac{3}{4}$ -inch, divided for lines and circles, and with rack and pinion movement.....	\$12.50	\$0.18
1078	Proportional Dividers, 9-inch, divided for lines and circles, and with micrometer screw.....	14.00	.20
1079	Proportional Dividers, 9-inch, divided for lines, circles, planes, and solids, and with micrometer screw.....	16.50	.20
	Morocco Cases for Proportional Dividers :		
	To fit Dividers Nos. 1074, 1075.....	1.00	.10
	“ “ No. 1076.....	1.40	.12
	“ “ Nos. 1078, 1079.....	1.60	.15
1084	Polar Planimeter, German silver, best quality, measuring up to 10 square inches, in mahogany case, with printed directions.....	16.50	.25
1086	Polar Planimeter, German silver, best quality, measuring up to 100 square inches, in morocco case, with printed directions.....	19.00	.25
1088	Polar Planimeter, German silver, best quality, measuring up to 450 square inches. Also indicates square feet and square centimeters. In morocco case, with printed directions.....	28.50	.35
1090	Polar Planimeter, German silver, with the tracer-arm graduated nearly its entire length and with vernier. Easily adjusted to any desired scale. In mahogany box, with printed directions.....	33.50	.75

By means of the Polar Planimeter a person can ascertain the area of any planimetric figure more accurately and in less time than the most experienced mathematician could calculate it.

The Planimeters mentioned above are the favorite styles and the best quality.

We can furnish cheaper Planimeters to order only, but do not keep them in stock.

EMPTY CASES FOR DRAWING-INSTRUMENTS

WITH TRAY FITTED COMPLETE, AND WITH LOCK. SPACE UNDER TRAY FOR SUNDRIES

No.	Size	MAHOGANY CASES FITTED, WITH TRAY		MOROCCO CASES FITTED, WITHOUT TRAY		
		Plain	Polished	Postage	Price	Postage
1092.....	8 x 3 $\frac{1}{2}$ inches	\$2.50	\$3.25	\$0.20	\$2.25	\$0.15
1093.....	8 x 4 inches	2.75	3.50	.20	2.50	.15
1094.....	8 x 5 inches	3.00	3.75	.25	2.75	.18
1095.....	9 x 5 inches	3.25	4.00	.30	3.00	.18
1096.....	10 x 6 inches	4.00	5.00	.35	4.00	.20
1097.....	11 x 7 inches	4.75	5.75	.50	4.50	.25
1098.....	13 x 7 inches	5.75	7.25	.75	5.00	.50

Other sizes made to order.

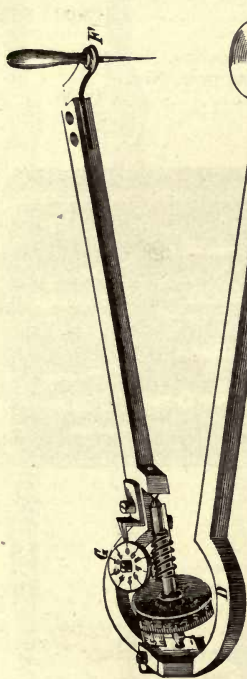

1086

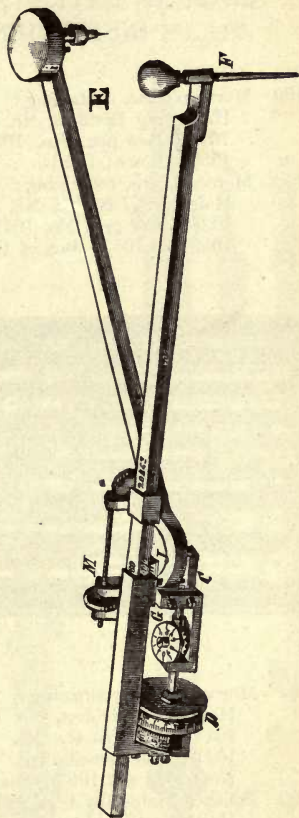

1088

See page 310.

SETS OF EXTRA FINE SWISS DRAWING- INSTRUMENTS IN CASES

No.		PRICE	POST.
1100	Morocco Case, containing : Hairspring Dividers, No. 1005 ; Compasses, No. 1019 ; Bow-pen, No. 1034 ; Drawing-pen, No. 1055 ; Box of Leads.....	\$13.00	\$0.15
1102	Morocco Case, containing : Hairspring Dividers, No. 1008 ; Compasses, No. 1024 ; Bow-pen, No. 1041 ; Drawing-pens, Nos. 1055 and 1057 ; Box of Leads	17.00	.20

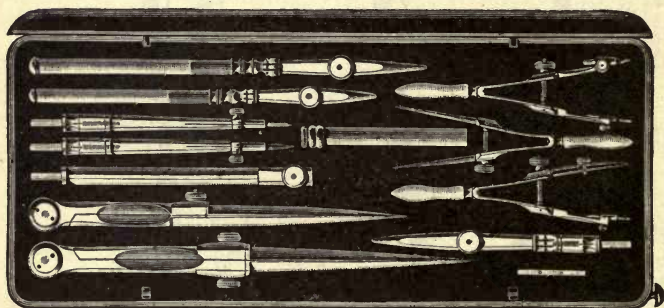

1104

1104	Morocco Case, containing : Hairspring Dividers, No. 1008 ; Compasses, No. 1024 ; Bow-spacer, No. 1039 ; Bow-pen, No. 1041 ; Bow-pencil, No. 1042 ; Drawing-pens, Nos. 1055 and 1057 ; Box of Leads.....	22.00	.25
1105	Polished Mahogany Box, with lock and tray, containing : Hairspring Dividers, No. 1008 ; Compasses, Nos. 1019 and 1024 ; Drawing-pens, Nos. 1055 and 1056 ; Box of Leads.....	21.00	.40
1106	Polished Mahogany Box, with lock and tray, containing : Plain Dividers, No. 1003 ; Hairspring Dividers, No. 1008 ; Compasses, Nos. 1018 and 1022 ; Bow-spacer, No. 1033 ; Bow-pen, No. 1034 ; Bow-pencil, No. 1035 ; Drawing-pens, Nos. 1055 and 1056 ; Box of Leads.....	27.00	.45

SUPERIOR SWISS DRAWING-INSTRUMENTS,
WITH PERFECT PIVOT-JOINTED HEADS

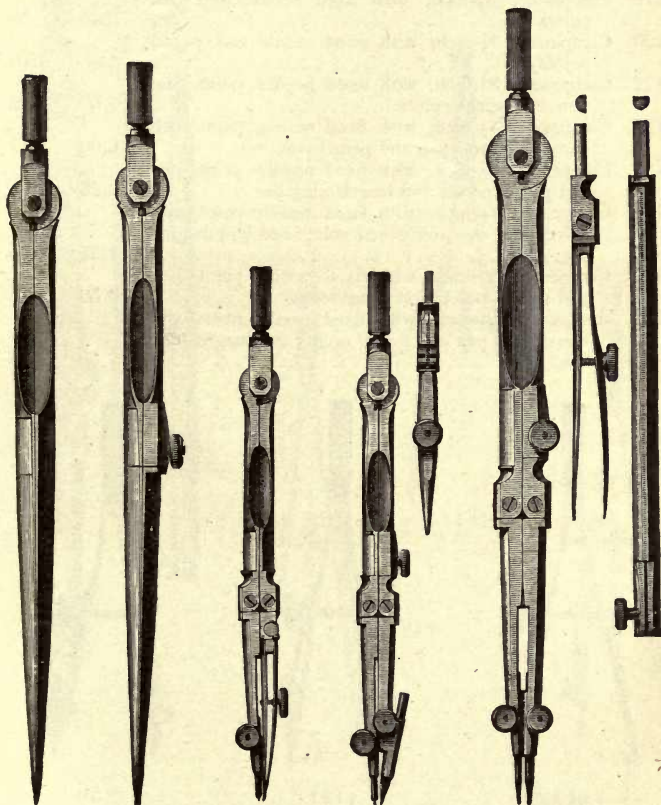

1112				
1116				
1119				
1122				
			1130	
No.			PRICE	Post.
1110	Plain Dividers, 3½-inch.....		\$2.00	\$0.10
1111	Plain Dividers, 4½-inch.....		2.35	.12
1112	Plain Dividers, 5-inch.....		2.50	.12
1114	Hairspring Dividers, 3½-inch.....		2.50	.10

No.		PRICE	Post.
1115	Hairspring Dividers, 4½-inch	\$3.00	\$0.12
1116	Hairspring Dividers, 5-inch	3.25	.12
1119	Compasses, 3½-inch, with fixed needle and pen points	3.35	.10
1120	Compasses, 3½-inch, with fixed needle and pencil points	3.35	.10
1122	Compasses, 3½-inch, with fixed needle point, and pen and pencil points	5.00	.12
1124	Compasses, 3½-inch, with fixed needle point with hairspring, and pen and pencil points	6.00	.12
1126	Compasses, 4½-inch, with fixed needle point, pen and pencil points and lengthening bar.	6.25	.15
1128	Compasses, 4½-inch, with fixed needle point with hairspring, pen and pencil points and lengthening bar.	7.25	.15
1130	Compasses, 5½-inch, with fixed needle point, pen and pencil points and lengthening bar.	6.50	.15
1132	Compasses, 5½-inch, with fixed needle point with hairspring, pen and pencil points and lengthening bar.	7.50	.15



1135



1137



1138

1135	Steelspring Bow-spacer, 3-inch, with metal handle.	1.50	.10
1135B	Steelspring Bow-spacer, 3½-inch, with metal handle.	1.80	.10
1136	Steelspring Bow-spacer, 3-inch, with needle points and metal handle.	2.25	.10
1137	Steelspring Bow-pen, 3-inch, with metal handle ..	2.25	.10



1132

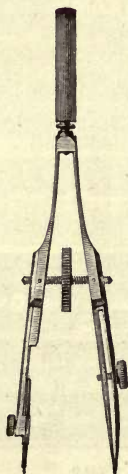

1142



1140



1143



1147



1148

For prices, see pages 314 and 316.

No.		PRICE	POST.
1137B	Steelspring Bow-pen, 3½-inch, with metal handle..	\$2.50	\$0.10
1138	Steelspring Bow-pencil, 3-inch, with metal handle .	2.25	.10
1138B	Steelspring Bow-pencil, 3½-inch, with metal handle.	2.50	.10
1140	Steelspring Bow-spacer, 3½-inch, with wheel adjust- ment	2.00	.10
1142	Steelspring Bow-pen, 3½-inch, with wheel adjust- ment	2.75	.10
1143	Steelspring Bow-pencil, 3½-inch, with wheel adjust- ment	2.75	.10
1147	Drawing-pen, with spring blade, ebony handle, 4½-inch	1.10	.10
1148	Drawing-pen, with spring blade, ebony handle, 5-inch	1.20	.10
1149	Drawing-pen, with spring blade, ebony handle, 5½-inch	1.35	.10

CASES OF SWISS DRAWING-INSTRUMENTS WITH PIVOT-JOINTED HEADS

- 1161 Morocco Case, containing:
Hairspring Dividers, No. 1115; Compasses, No.
1126; Drawing-pen, No. 1148; Box of Leads.. \$12.00 \$0.15

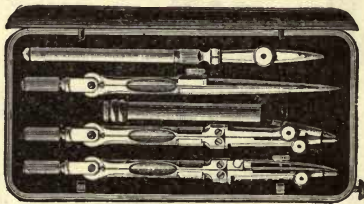

1162

- 1162 Morocco Case, containing:
Hairspring Dividers, No. 1114; Compasses, Nos.
1119 and 1120; Drawing-pen, No. 1147; Box of
Leads
- 12.00 .15
- 1163 Morocco Case, containing:
Hairspring Dividers, No. 1115; Compasses, No.
1126; Bow-pen, No. 1137; Drawing-pens, Nos.
1147 and 1148; Box of Leads
- 16.00 .20

No.		PRICE	Post.
1164	Morocco Case, containing: Hairspring Dividers, No. 1116; Compasses, Nos. 1124 and 1130; Drawing-pens, Nos. 1147 and 1148; Box of Leads	\$20.00	\$0.20
1165	Morocco Case, containing: Hairspring Dividers, No. 1116; Compasses, No. 1130; Bow-spacer, 3½-inch; Bow-pen, 3½-inch; Bow-pencil, 3½-inch; Drawing-pens, Nos. 1147 and 1148; Box of Leads.....	21.50	.25

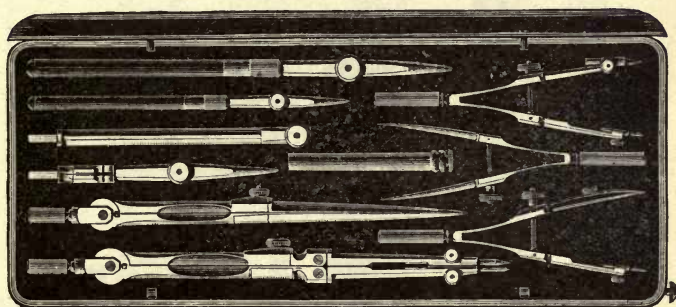

1165-1166

1166	Morocco Case, containing: Hairspring Dividers, No. 1115; Compasses, No. 1126; Bow-spacer, No. 1135; Bow-pen, No. 1137; Bow-pencil, No. 1138; Drawing-pens, Nos. 1147 and 1148; Box of Leads	20.00	.20
1167	Morocco Case, containing: Hairspring Dividers, No. 1116; Compasses, Nos. 1124 and 1130; Bow-pen, No. 1137; Drawing-pens, Nos. 1147, 1148, and 1149; Box of Leads	24.00	.25
1168	Folding Pocket Case with flexible flaps (see page 323), and containing same instruments as in set No. 1166.....	21.25	.20
1169A	Folding Pocket Case with flexible flaps, and containing same instruments as in set No. 1165.....	22.75	.25
1169B	Same outfit as No. 1169A, but with hairspring attachment on large Compass.....	23.75	.25

ALTENER'S PATENT JOINT GERMAN SILVER AND STEEL DRAWING-INSTRUMENTS

WARRANTED GENUINE

The excellence of these instruments consists in the joints of the dividers being so constructed as to prevent any irregular motion when the legs are opened or closed, also in the general care with which the instruments are finished. All the pens are well made and pointed.

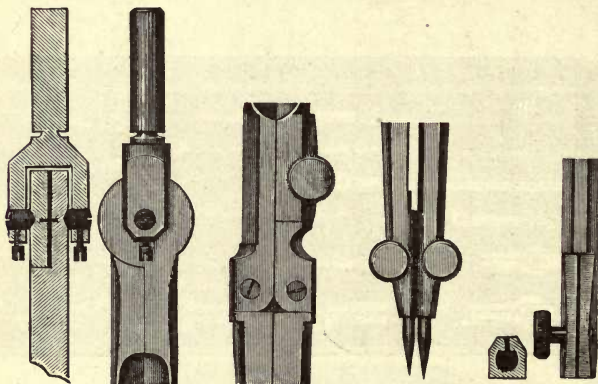

Altener's
Patent Joint

Knuckle-
Joints

Clamp-
Holders

Clamp-
Sockets

No.		PRICE	POST.
1170	Plain Dividers, $3\frac{1}{2}$ -inch.....	\$2.25	\$0.10
1171	Plain Dividers, $4\frac{1}{2}$ -inch.....	2.50	.12
1172	Plain Dividers, 5-inch.....	2.50	.12
1174	Hairspring Dividers, $3\frac{1}{2}$ -inch.....	3.50	.10
1175	Hairspring Dividers, $4\frac{1}{2}$ -inch.....	3.75	.12
1176	Hairspring Dividers, 5-inch.....	4.00	.12
1180	Compasses, $3\frac{1}{2}$ -inch, with fixed needle and pen points.....	4.00	.10
1181	Compasses, $3\frac{1}{2}$ -inch, with fixed needle and pencil points.....	4.00	.10
1182	Compasses, $4\frac{1}{2}$ -inch, with fixed needle and pen points.....	4.50	.12
1183	Compasses, $4\frac{1}{2}$ -inch, with fixed needle and pencil points.....	4.50	.12

See cuts on page 319.

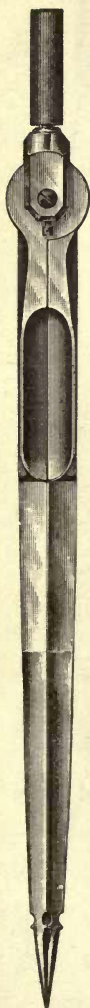

1171

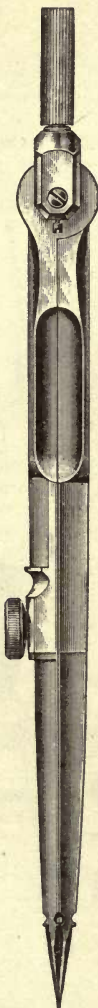

1175



1182

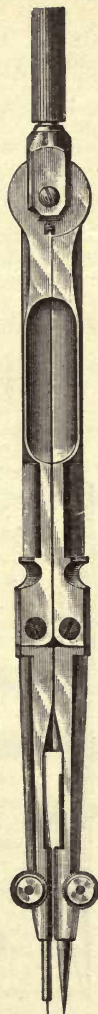

1183

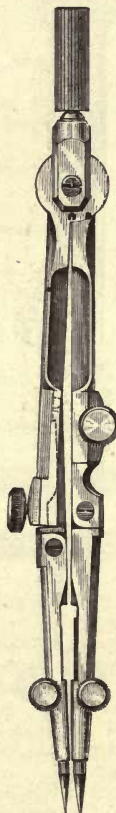

1187



For prices, see pages 318 and 321.



1190

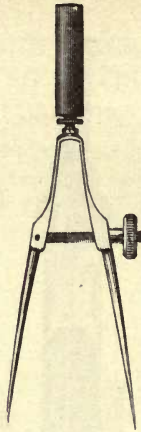

1195

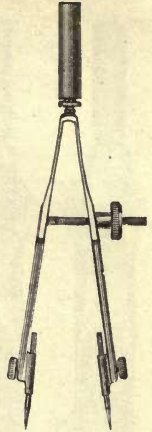

1196



1197

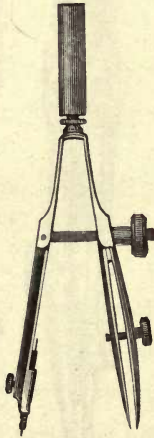

1198

For prices, see page 321.

No.		PRICE	POST.
1184	Compasses, 5½-inch, with fixed needle and pen points	\$5.00	\$0.12
1185	Compasses, 5½-inch, with fixed needle and pencil points	5.00	.12
1186	Compasses, 3½-inch, with fixed needle point, and pen and pencil points	6.00	.12
1187	Compasses, 3½-inch, with fixed needle point with hairspring, and pen and pencil points.	7.50	.12
	See cut of No. 1187 on page 319.		
1188	Compasses, 4½-inch, with fixed needle point, and pen and pencil points and lengthening bar	7.25	.14
1189	Compasses, 4½-inch, with fixed needle point with hairspring, and pen and pencil points and lengthening bar	8.75	.14
1190	Compasses, 5½-inch, with fixed needle point, pen and pencil points and lengthening bar	7.50	.15
1191	Compasses, 5½-inch, with fixed needle point with hairspring, pen and pencil points and lengthening bar	9.00	.15
1195	Steelspring Bow-spacer, metal handle, 3¼-inch . . .	1.75	.10
1196	Steelspring Bow-spacer, needle points, metal handle, 3¼-inch	2.50	.10
1197	Steelspring Bow-pen, needle point, metal handle, 3¼-inch	2.50	.10
1198	Steelspring Bow-pencil, needle point, metal handle, 3¼-inch	2.50	.10

See cuts of Nos. 1190 to 1198 on page 320.

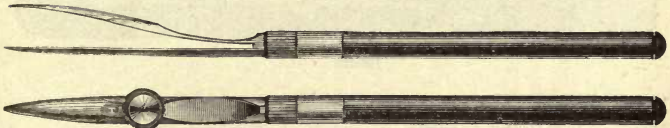

1206

1206	Drawing-pen, with spring blade, ebony handle, 4¼-inch	1.40	.10
1207	Drawing-pen, with spring blade, ebony handle, 5-inch	1.65	.10
1208	Drawing-pen, with spring blade, ebony handle, 5½-inch	1.90	.10
1209	Drawing-pen, with patent spring hinge, ebony handle, 5-inch	2.90	.10
1210	Railroad-pen, ebony handle, 5-inch	3.50	.10
1211	Swivel Curve-pen, spring blade, hollow metal handle.	2.00	.10
1212	Pricker, with removable needle point, ebony handle.	1.00	.10
1214	Nickel-plated case, for leads.15	.02

ALTENER'S PATENT JOINT DRAWING-INSTRUMENTS IN MOROCCO CASE

No.		PRICE	POST.
1220	Morocco Case, containing: Compasses, Nos. 1180 and 1181; Drawing-pen, No. 1206; Box of Leads.....	\$10.75	\$0.15
1222	Morocco Case, containing: Hairspring Dividers, No. 1175; Compasses, No. 1188; Drawing-pen, No. 1207; Box of Leads..	14.25	.18
1224	Morocco Case, containing: Hairspring Dividers, No. 1175; Compasses, No. 1189; Bow-pen, No. 1197; Drawing-pen, No. 1207; Box of Leads.....	18.50	.20

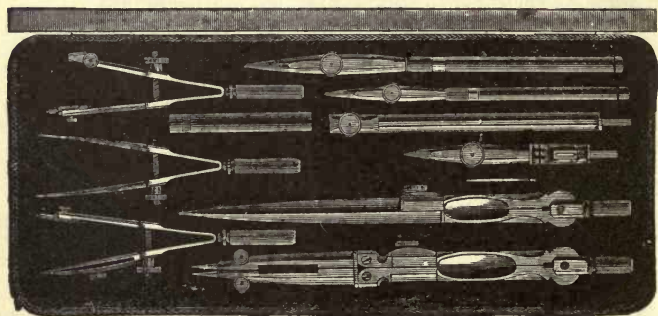

1225

1225	Morocco Case, containing: Hairspring Dividers, No. 1176; Compasses, No. 1190; Bow-spacer, No. 1195; Bow-pen, No. 1197; Bow-pencil, No. 1198; Drawing-pens, Nos. 1206 and 1207; Box of Leads	23.50	.20
1227	Morocco Case, containing: Hairspring Dividers, No. 1176; Compasses, No. 1191; Bow-spacer, No. 1195; Bow-pen, No. 1197; Bow-pencil, No. 1198; Drawing-pens, Nos. 1206 and 1207; Box of Leads	25.00	.25
1228	Morocco Case, containing: Hairspring Dividers, No. 1176; Compasses, Nos. 1186 and 1190; Bow-spacer, No. 1195; Bow- pen, No. 1197; Bow-pencil, No. 1198; Drawing- pens, Nos. 1206 and 1207; Box of Leads.....	30.00	.30



CLOSED.

1230

No.		PRICE	POST.
1230	Folding Pocket Case, with flexible flaps, and containing same instruments as in set No. 1225.....	\$24.75	\$0.20
1232	Empty Folding Pocket Case, with flexible flaps, and fitted to receive from five to twelve pieces of drawing-instruments; price, according to size of case.....	PRICE \$3.00 to \$4.00	POST. \$0.12 to \$0.20

Folding Pocket Cases furnished, instead of the usual Morocco Cases, with sets Nos. 1220 to 1227, at an extra cost of \$1.25, and with set No. 1228 at \$1.50 extra.

BEST GERMAN DRAWING-INSTRUMENTS

OF FINE GERMAN SILVER AND STEEL

For prices of empty cases for Drawing-Instruments, see page 310.

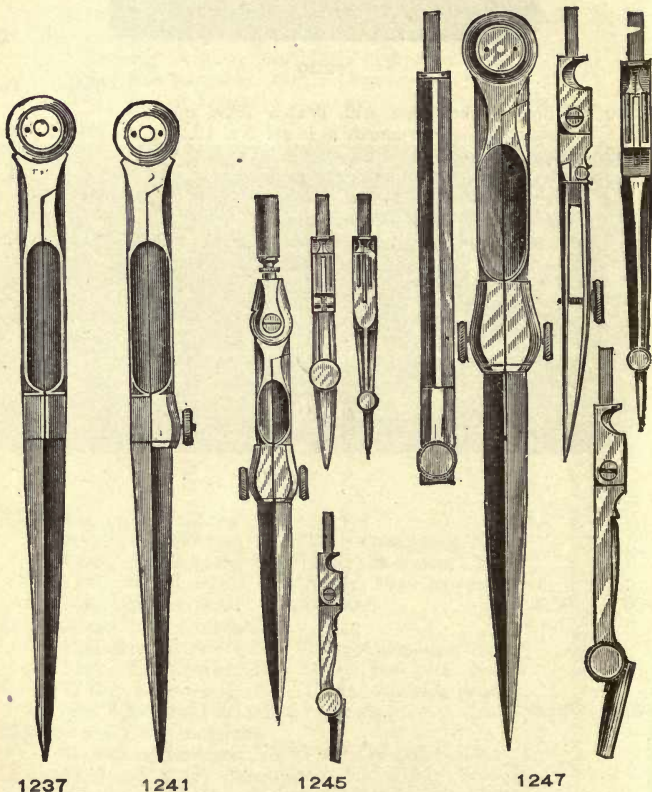

For prices, see page 325. Nos. 1237, 1241 and 1247 are now made with handles.

No.		PRICE	POST.
1235	Plain Dividers, $3\frac{1}{2}$ -inch, with handle.....	\$0.70	\$0.02
1237	Plain Dividers, 5-inch, with handle.....	.80	.03
1238	Plain Dividers, 6-inch, with handle.....	1.00	.04
1240	Hairspring Dividers, $3\frac{1}{2}$ -inch, with handle.....	1.20	.10
1241	Hairspring Dividers, 5-inch, with handle.....	1.50	.11
1242	Hairspring Dividers, 6-inch, with handle.....	1.75	.12
1245	Compasses, $3\frac{1}{2}$ -inch, with pen, pencil and needle points.....	2.50	.12
1247	Compasses, $5\frac{1}{2}$ -inch, with pen, pencil and needle points and lengthening bar.....	3.00	.15



1250



1251



1253

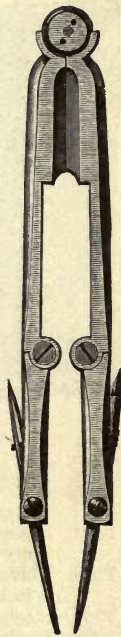

1257

No.		PRICE	Post.
1250	Pocket Dividers, 5-inch, with sheath.....	\$1.50	\$0.12
1251	Three-legged Dividers, 5-inch, for taking off three points ..	2.75	.13
1253	Proportional Dividers, 6½-inch, divided for lines...	2.50	.15
1254	Proportional Dividers, 7-inch, for lines and circles..	3.25	.15
1255	Proportional Dividers, 7-inch, with rack movement and divided for lines and circles.....	5.20	.15
1257	Pocket Compasses, with folding points	5.00	.12

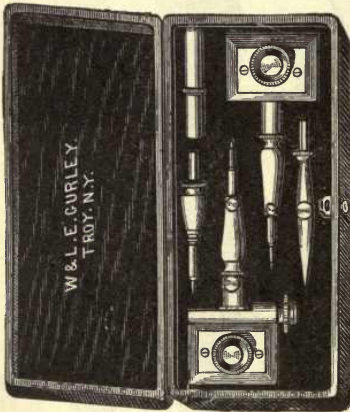

1259

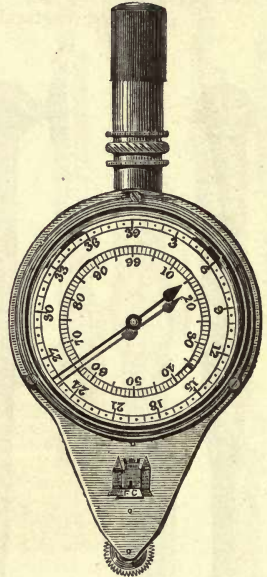

1260

1258	Beam-Compass Furniture, with pen, pencil and needle points, with tangent adjustment, in case ..	5.00	.16
1259	Beam-Compass Furniture, with pen, pencil and needle points, in morocco case	6.00	.16
1260	Universal Map-Measurer. The index-hand registers inches to miles, or centimeters to kilometers.....	3.00	.12
1267	Steelspring Bow-spacer, ivory handle, 3½-inch.....	1.00	.10
1268	Steelspring Bow-pen, ivory handle, 3½-inch.....	1.25	.10
1269	Steelspring Bow-pencil, ivory handle, 3½-inch	1.25	.10

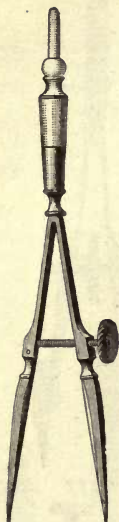

1267

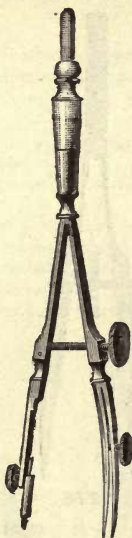

1268



1269

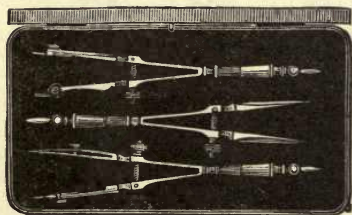

1270

No.		PRICE	POST.
1270	Set of three Steel Bows, Nos. 1267, 1268 and 1269, in morocco case.....	\$4.20	\$0.15
1275	Bow-spacer, with wheel adjustment, metal handle, 3½-inch.....	1.50	.10
1276	Bow-pen, with wheel adjustment, metal handle, 3½-inch.....	1.75	.10
1277	Bow-pencil, with wheel adjustment, metal handle, 3½-inch.....	1.75	.10
1278	Set of three Steel Bows, Nos. 1275, 1276 and 1277, in morocco case.....	5.75	.15



1275

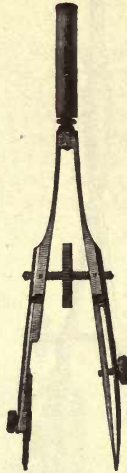

1276

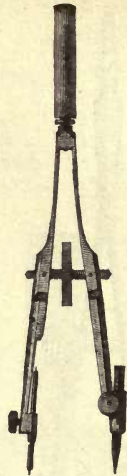

1277

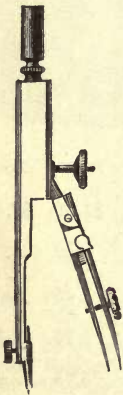

1279



1280



1282



1283

For prices, see pages 327 and 329.

No.		PRICE	POST.
1279	Spring Bow-pen, with adjusting-screw.....	\$1.40	\$0.10
1280	Spring Bow-pen, with pencil leg and adjusting-screw	2.00	.10
1282	Spring Bow-pen, with adjustable needle point for small circles	2.50	.10
1283	Spring Bow-pen, with pencil leg, and adjustable needle point for small circles.....	3.50	.10
1284	Spring Bow-pen, with spring needle point for small circles	2.75	.10
1290	Drawing-pen, without joint, ivory handle, $4\frac{1}{2}$ -inch..	.35	.02
1292	Drawing-pen, without joint, ivory handle, $5\frac{1}{2}$ -inch..	.40	.03
1294	Drawing-pen, with fine joint, ivory handle, $4\frac{1}{2}$ -inch..	.50	.02
1295	Drawing-pen, with fine joint, ivory handle, 5-inch...	.55	.03
1296	Drawing-pen, with fine joint, ivory handle, $5\frac{1}{2}$ -inch..	.60	.03

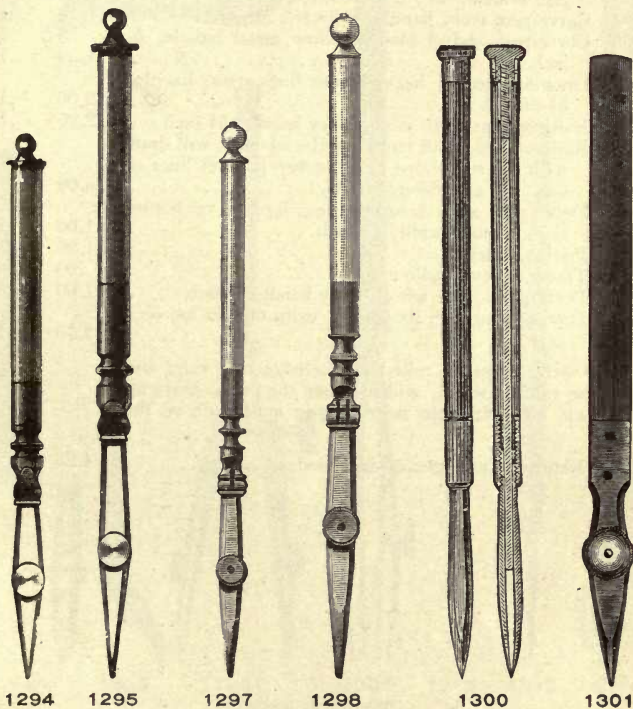

No.		PRICE	POST.
1297	Drawing-pen, with fine joint and pin, ivory handle, 4½-inch	\$0.65	\$0.02
1298	Drawing-pen, with fine joint and pin, ivory handle, 5-inch70	.03
1299	Drawing-pen, with fine joint and pin, ivory handle, 5½—6-inch.....	.75	.03
1300	Drawing-pen, without set-screw, hollow metal handle, 5½-inch.....	1.45	.10
1301	Drawing-pen, Swedish pattern, ebony handle, 5-inch75	.03
1302	Drawing-pen, Swedish pattern, ebony handle, 6-inch.....	.85	.03
1303	Drawing-pen, with German silver blades, for red ink, 5-inch65	.03
1304	Curve-pen, ivory handle, 4½-inch.....	1.25	.10
1305	Curve-pen, swivel blade, hollow metal handle, 5-inch.....	1.50	.10
1306	Drawing-pen, for heavy border lines, ivory handle, 5½-inch	2.00	.10
1307	Railroad-pen, with joints, ivory handle, 5½-inch...	2.25	.10
1308	Railroad-pen, with ivory handle, 5½-inch, will draw with one stroke one broad or two parallel lines of the same or different widths	3.00	.10
1309	Detail-pen, with broad blades, for heavy border lines, ebony handle, 6¼-inch.....	1.00	.10
1310	Pricker, ivory handle.....	1.20	.10
1312	Tracer, ivory handle90	.02
1314	Dotting-pen, one wheel, ivory handle, 5-inch.....	1.00	.03
1316	Dotting-pen, with six wheels, extra fine, in morocco case.....	3.75	.12

The outer wheel is rolled on the edge of a ruler and turns the ratchet wheel, which causes the pen to move up and down. The flat point near the pen must slide on the paper.

1318	Railroad Curve-pen, swivel blades.....	4.25	.12
------	--	------	-----

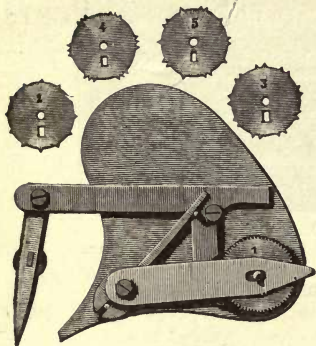

1316



1304



1305



1307



1308



1310



1312



1314

For prices, see page 330.

CASES OF FINE GERMAN SILVER INSTRUMENTS
FOR ENGINEERS, ARCHITECTS AND MACHINISTS

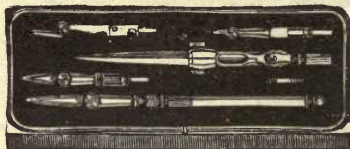

1330

No.		PRICE	POST.
1330	Morocco Case, containing: Compasses, No. 1245; Drawing-pen, No. 1294; Box of Leads	\$3.25	\$0.12
1331	Morocco Case, containing: Plain Dividers, No. 1235; Compasses, No. 1245; Drawing-pen, No. 1294; Box of Leads	4.00	.13
1333	Morocco Case, containing: Plain Dividers, No. 1237; Compasses, 5½-inch, with fixed needle point, pen and pencil points; Drawing-pen, No. 1295; Box of Leads	3.50	.15
1334	Morocco Case, containing: Plain Dividers, No. 1237; Compasses, 5½-inch, with fixed needle point, pen and pencil points; Bow-pen, No. 1268; Drawing-pen, No. 1295; Box of Leads	4.75	.18
1335	Morocco Case, containing: Plain Dividers, No. 1237; Compasses, No. 1247; Drawing-pen, No. 1299; Box of Leads	5.00	.18

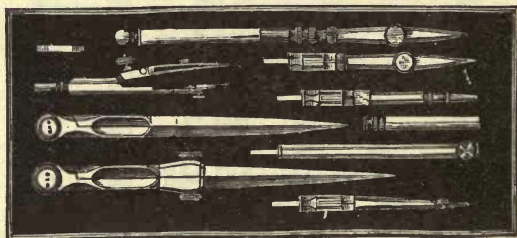

1339

1339	Morocco Case, containing: Plain Dividers, No. 1237; Compasses, No. 1247; Bow-pen, No. 1268; Drawing-pen, No. 1299; Box of Leads	6.50	.18
------	--	------	-----

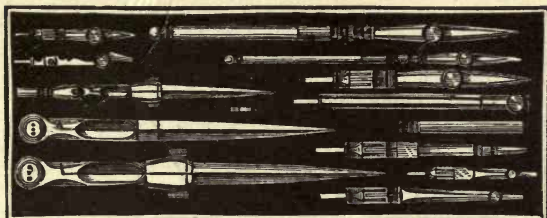

1340

No.		PRICE	POST.
1340	Morocco Case, containing: Plain Dividers, No. 1237; Compasses, Nos. 1245 and 1247; Drawing-pens, Nos. 1297 and 1299; Box of Leads	\$ 8.75	\$0.20
1341	Morocco Case, containing: Plain Dividers, No. 1237; Compasses, Nos. 1245 and 1247; Bow-pen, No. 1268; Drawing-pens, Nos. 1297 and 1299; Box of Leads	10.00	.20
1342	Morocco Case, containing: Plain Dividers, No. 1241; Compasses, No. 1247; Bow-spacer, No. 1267; Bow-pen, No. 1268; Bow-pencil, No. 1269; Drawing-pens, Nos. 1297 and 1299; Box of Leads.....	10.00	.20

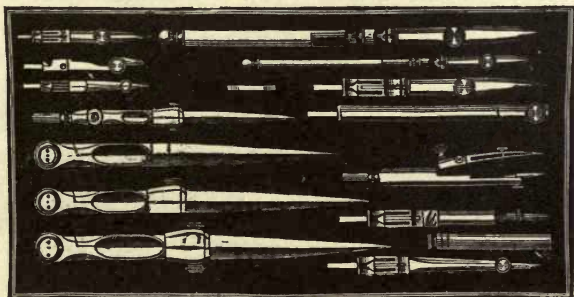

1345

1345	Polished Mahogany Box, with lock and tray, containing: Plain Dividers, No. 1237; Hairspring Dividers, No. 1241; Compasses, Nos. 1245 and 1247; Bow-pen, No. 1279; Drawing-pens, Nos. 1297 and 1299; Box of Leads.....	14.50	.45
------	---	-------	-----

No.		PRICE	POST.
1346	Polished Mahogany Box, with lock and tray, containing: Hairspring Dividers, No. 1241; Compasses, Nos. 1245 and 1247; Proportional Dividers, No. 1253; Bow-pen, No. 1268; Drawing-pens, Nos. 1297 and 1299; Box of Leads.....	\$16.00	\$0.50
1348	Polished Mahogany Box, with lock and tray, containing: Hairspring Dividers, No. 1241; Compasses, No. 1247; Proportional Dividers, No. 1253; Bow-spacer, No. 1267; Bow-pen, No. 1268; Bow-pencil, No. 1269; Railroad-pen, No. 1307; Curve-pen, No. 1304; Drawing-pens, Nos. 1297, 1299 and 1301; Box of Leads.....	20.00	.55
1352	Polished Mahogany Box, with lock and tray, containing: Plain Dividers, No. 1237; Hairspring Dividers, No. 1241; Compasses, Nos. 1245 and 1247; Proportional Dividers, No. 1255; Bow-spacer, No. 1275; Bow-pen, No. 1276; Bow-pencil, No. 1277; Railroad-pen, No. 1308; Curve-pen, No. 1305; Drawing-pens, Nos. 1294, 1298 and 1301; Beam-compass, No. 1259; Box of Leads.	35.00	.75

The Dividers and Compasses in sets Nos. 1330 and 1352 are now made with handles.

SETS OF PIVOT-JOINT INSTRUMENTS OF BEST GERMAN MAKE

FINE GERMAN SILVER AND STEEL

No.		PRICE	Post.
1355	Morocco Case, containing: Plain Dividers, 5-inch; Compasses, 5½-inch, with fixed needle point, pen and pencil points and lengthening bar; Drawing-pen; Box of Leads...	\$ 8.00	\$0.15
1356	Morocco Case, containing: Plain Dividers, 3½-inch; Compasses, 3½-inch, with fixed needle and pen points; Compasses, 3½-inch, with fixed needle and pencil points; Drawing-pen; Box of Leads.....	9.00	.15
1357	Morocco Case, containing: Plain Dividers, 5-inch; Compasses, 5½-inch, with fixed needle point, pen and pencil points and lengthening bar; Bow-pen; Drawing-pen; Box of Leads	9.50	.18

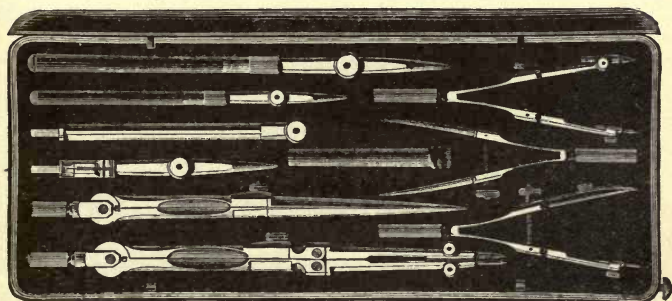

1358

1358	Morocco Case, containing: Hairspring Dividers, 5-inch; Compasses, 5½-inch, with fixed needle point, pen and pencil points and lengthening bar; Bow-spacer; Bow-pen; Bow-pencil; two Drawing-pens; Box of Leads.....	12.50	.20
1359	Folding Pocket Case, with flexible flaps, see page 323, and containing same instruments as in set No. 1358.....	13.75	.20

SETS OF GERMAN SILVER DRAWING-INSTRUMENTS FOR SCHOOL USE

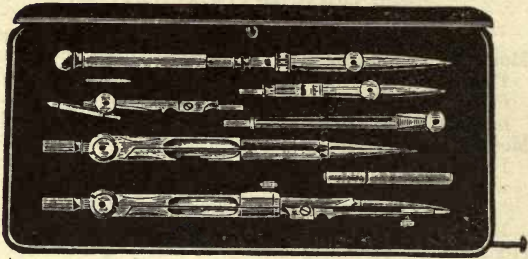

1365

No.		PRICE	POST.
1365	Leather Case, containing: Plain Dividers, 5-inch; Compasses, 5½-inch, with fixed needle point, pen and pencil points and lengthening bar; Drawing-pen; Box of Leads..	\$ 3.00	\$.13

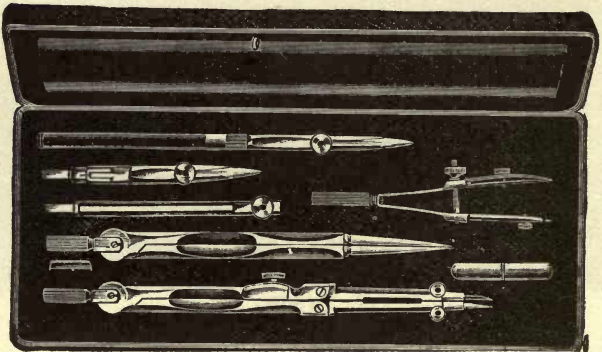

1367

1367	Leather Case, containing: Plain Dividers, 5-inch; Compasses, 5½-inch, with fixed needle point, pen and pencil points and lengthening bar; Bow-pen; Drawing-pen; Box of Leads.....	4.00	.15
------	---	------	-----

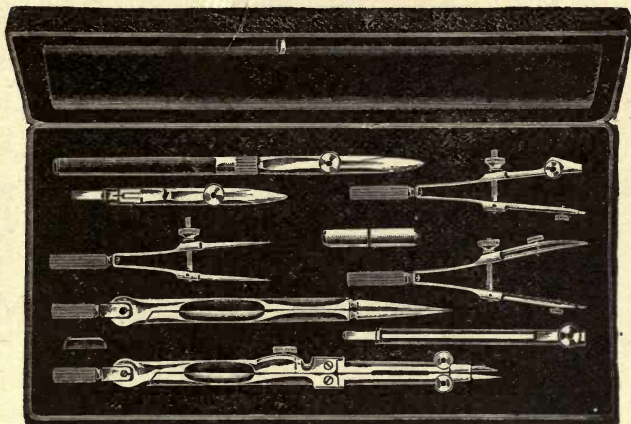

1369

No.		PRICE	POST.
1369	Leather Case, containing: Plain Dividers, 5-inch; Compasses, 5½-inch, with fixed needle point, pen, pencil and lengthening bar; Bow-spacer; Bow-pen; Bow-pencil; Draw- ing-pen; Box of Leads	\$ 6.00	\$0.18
1371	Leather Case, containing: Plain Dividers, 5-inch; Compasses, 3½-inch, with fixed needle point, pen and pencil point; Com- passes, 5½-inch, with fixed needle point, pen, pencil and lengthening bar; Bow-spacer; Bow- pen; Bow-pencil; two Drawing-pens; Box of Leads.....	9.00	.20

BRASS DRAWING-INSTRUMENTS
FOR SCHOOL USE

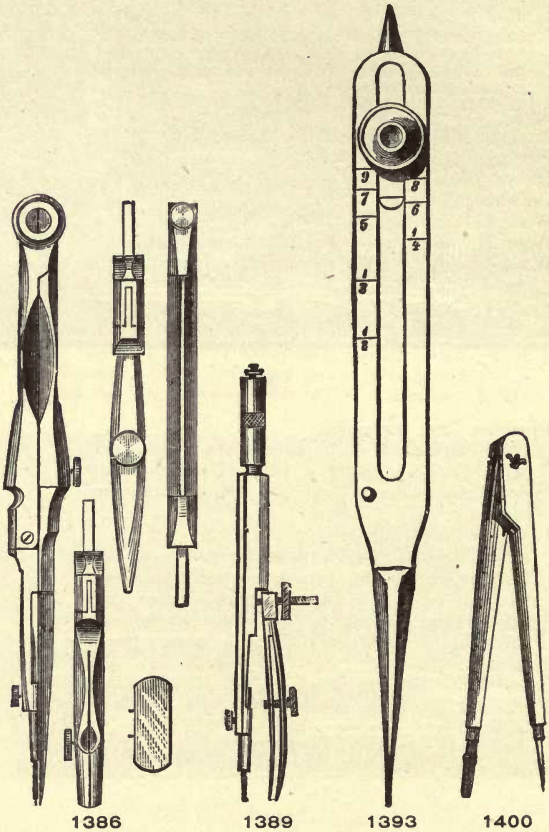

No.		PRICE	Post.
1375	Plain Dividers, rivet-joint, 4-inch.....	\$0.15	\$0.02
1376	Plain Dividers, rivet-joint, 5-inch.....	.20	.03
1378	Plain Dividers, screw-joint, 4-inch.....	.20	.02
1379	Plain Dividers, screw-joint, 5-inch.....	.25	.03

No.		PRICE	POST.
1385	Compasses, $4\frac{1}{2}$ -inch, with pen and pencil points and lengthening bar.....	\$0.50	\$0.05
1386	Compasses, $4\frac{1}{2}$ -inch, with fixed needle point, pen and pencil points and lengthening bar.....	.60	.05
1387	Compasses, 6-inch, with pen and pencil points and lengthening bar.....	.65	.08
1388	Compasses, 6-inch, with fixed needle point, pen and pencil points and lengthening bar.....	.75	.08
1389	Spring Bow-pen, with needle point, 3-inch.....	.60	.02
1391	Roulette, with three wheels, for dotting lines.....	.75	.03
1393	Proportional Dividers, $6\frac{1}{2}$ -inch, divided for lines ...	1.50	.13
1395	Drawing-pen, wood handle.....	.15	.02
1396	Drawing-pen, bone handle.....	.20	.02
1400	Wood Dividers, with crayon holder, 12-inch.....	1.00	.15
1401	Wood Dividers, with crayon holder, 15-inch.....	1.25	.18
1402	Wood Dividers, with crayon holder, 18-inch.....	1.50	.20

CASES OF BRASS DRAWING-INSTRUMENTS

FOR SCHOOL USE

1405	Rosewood Box, containing : Plain Dividers, $4\frac{1}{2}$ -inch ; Compasses, 4-inch, with pen and pencil points ; Compasses, 6-inch, with pen and pencil points and lengthening bar ; Drawing-pen ; Brass and Horn Protractors ; Wood Rule	\$2.00	\$0.23
1406	Rosewood Box, with lock and tray, containing : Plain Dividers, $4\frac{1}{2}$ -inch ; Compasses, 4-inch, with fixed needle point, pen and pencil points ; Compasses, 6-inch, with fixed needle point, pen and pencil points and lengthening bar ; Drawing-pen ; Brass and Horn Protractors ; Wood Rule.....	3.00	.28
1407	Rosewood Box, etc., same as No. 1406, and with addition of Spring Bow-pen.....	3.75	.28
1408	Rosewood Box, etc., same as No. 1406, and with addition of Spring Bow-pen, Proportional Dividers, Triangle and Irregular Curve, and omitting Brass Protractor.....	5.50	.35

NICKEL-PLATED DRAWING-INSTRUMENTS

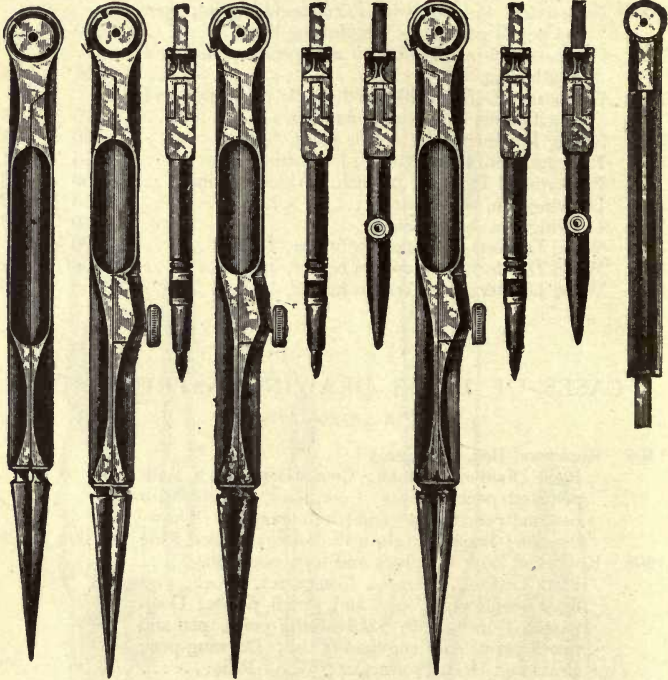

1413

1416

1418

1420



1425 AND 1427

For prices of Nos. 1413 to 1427, see page 341.

NICKEL-PLATED BRASS DRAWING-INSTRUMENTS

FOR SCHOOL USE. SEE PAGE 340

No.		PRICE	Post.
1410	Plain Dividers, rivet-joint, $4\frac{1}{2}$ -inch.....	\$0.20	\$0.02
1411	Plain Dividers, rivet-joint, $5\frac{1}{2}$ -inch.....	.25	.03
1413	Plain Dividers, screw-joint, $4\frac{1}{2}$ -inch.....	.25	.02
1414	Plain Dividers, screw-joint, $5\frac{1}{2}$ -inch.....	.30	.03
1416	Compasses, $4\frac{1}{2}$ -inch, with pencil point.....	.35	.03
1418	Compasses, $4\frac{1}{2}$ -inch, with pen and pencil points.....	.50	.04
1420	Compasses, $4\frac{1}{2}$ -inch, with pen and pencil points and lengthening bar.....	.65	.05
1425	Drawing-pen, black wood handle, 5-inch.....	.20	.03
1427	Drawing-pen, bone handle, 5-inch.....	.30	.03

SETS OF NICKEL-PLATED DRAWING-INSTRUMENTS IN LEATHERETTE CASES

FOR SCHOOL USE

1430	Case, containing: Compasses, $4\frac{1}{2}$ -inch, with pen and pencil points; Box of Leads; Color-saucer.....	\$0.65	\$0.08
1431	Case containing: Compasses, $4\frac{1}{2}$ -inch, with pen and pencil points; Drawing-pen; Box of Leads; Color-saucer; Protractor, Ruler and Triangle.....	.85	.10

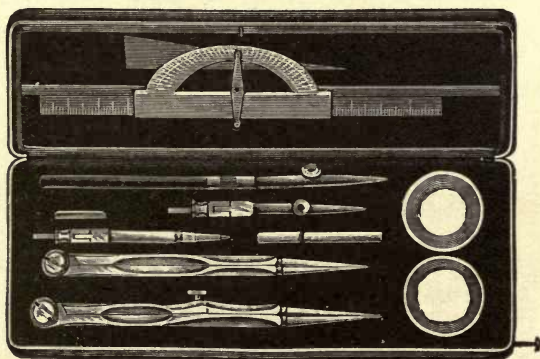

1433

No.
1433

PRICE POST.

Case, containing :

Plain Dividers, 4-inch ; Compasses, $4\frac{1}{2}$ -inch,
with pen and pencil points ; Drawing-pen ; Box
of Leads ; Color-saucers ; Protractor, Ruler and
Triangle..... \$1.20 \$0.15

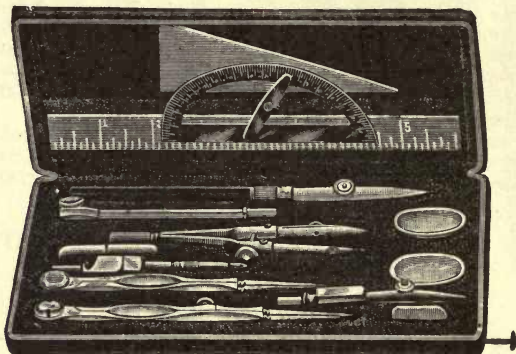

1436

1436 Case, containing :

Plain Dividers, 4-inch ; Compasses, $4\frac{1}{2}$ -inch, with
pen and pencil points and lengthening bar ;
Spring Bow-pen ; Drawing-pen ; Box of Leads ;
Color-saucers ; Protractor, Ruler and Triangle.... 2.00 .20

PROTRACTORS

EXTRA FINE SWISS GERMAN SILVER PROTRACTORS

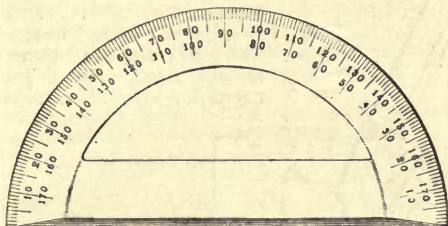

1442

No.		PRICE	POST.
1440	Protractor, half-circle, 4-inch, beveled edge, center on outer edge, divided to 1 degree.....	\$2.25	\$0.12
1441	Protractor, half-circle, 5-inch, divided to $\frac{1}{2}$ degrees..	3.35	.13
1442	Protractor, half-circle, 6-inch, divided to $\frac{1}{2}$ degrees..	3.85	.15
1443	Protractor, half-circle, 6-inch, divided to $\frac{1}{4}$ degrees..	4.75	.15

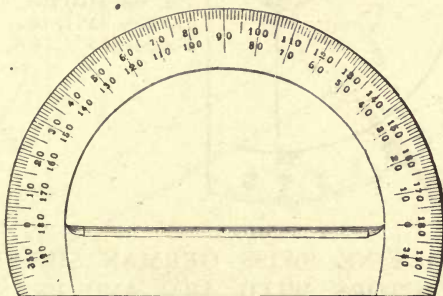

1446

1445	Protractor, half-circle, 5-inch, beveled edge, center on inner edge, divided to $\frac{1}{2}$ degrees.....	\$3.85	\$0.14
1446	Protractor, half-circle, 6-inch, divided to $\frac{1}{2}$ degrees..	4.35	.16
1447	Protractor, half-circle, 6-inch, divided to $\frac{1}{4}$ degrees..	5.25	.16
1450	Protractor, whole circle, 5-inch, divided to $\frac{1}{2}$ degrees	7.75	.20

EXTRA FINE SWISS GERMAN SILVER
PROTRACTORS, WITH ARM AND
WITHOUT VERNIER

No.		PRICE	POST.
1454	Protractor, half-circle, 6-inch, with horn center and 6-inch movable arm, divided to $\frac{1}{2}$ degrees	\$11.50	\$0.20
1455	Protractor, half-circle, 7-inch, with horn center and 6-inch movable arm, divided to $\frac{1}{2}$ degrees	13.00	.25

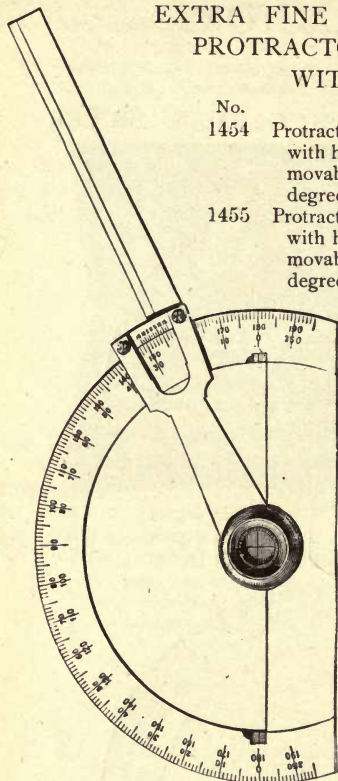

Length of arms extending over
the outer edge of
Protractors

For Nos. 1460 and 1465, $5\frac{1}{2}$ -inch
For Nos. 1461, 1466, 1470, 6-inch
For Nos. 1462, 1467, 1473, $6\frac{1}{2}$ -inch

1461

EXTRA FINE SWISS GERMAN SILVER PRO-
TRACTORS, WITH ARM AND VERNIER

No.		PRICE	POST.
1460	Protractor, half-circle, $5\frac{1}{2}$ -inch, with horn center and movable arm, divided to $\frac{1}{2}$ degrees, vernier reading to 3 minutes	\$14.00	\$0.20
1461	Protractor, half-circle, 8-inch, divided to $\frac{1}{3}$ degrees, vernier to 1 minute	17.00	.25

No.		PRICE	POST.
1462	Protractor, half-circle, 10-inch, divided to $\frac{1}{4}$ degrees, vernier to 1 minute.....	\$21.00	\$0.35
1465	Protractor, whole circle, $5\frac{1}{2}$ -inch, with horn center and movable arm, divided to $\frac{1}{2}$ degrees, vernier reading to 3 minutes.....	17.00	.30
1466	Protractor, whole circle, 8-inch, divided to $\frac{1}{4}$ degrees, vernier to 1 minute.....	20.00	.35
1467	Protractor, whole circle, 10-inch, divided to $\frac{1}{4}$ degrees, vernier to 1 minute.....	23.00	.50
1470	Protractor, half-circle, 8-inch, with horn center and movable arm, divided to $\frac{1}{4}$ degrees, vernier to 1 minute, with clamp and tangent to arm.....	23.00	.30
1473	Protractor, whole circle, 8-inch, with horn center and movable arm, divided to $\frac{1}{4}$ degrees, vernier to 1 minute, with clamp and tangent to arm.....	26.00	.40

MAHOGANY CASES FOR PROTRACTORS

1476	Case for Protractors Nos. 1454, 1455, 1460.....	\$1.75	\$0.25
1477	Case for Protractors Nos. 1461, 1462, 1465, 1470...	2.25	.35
1478	Case for Protractors Nos. 1466, 1467, 1473.....	3.00	.45

LIMB-PROTRACTOR

BRONZE HEAD, STEEL BLADE, VERNIER TO ONE MINUTE

Made by W. & L. E. Gurley

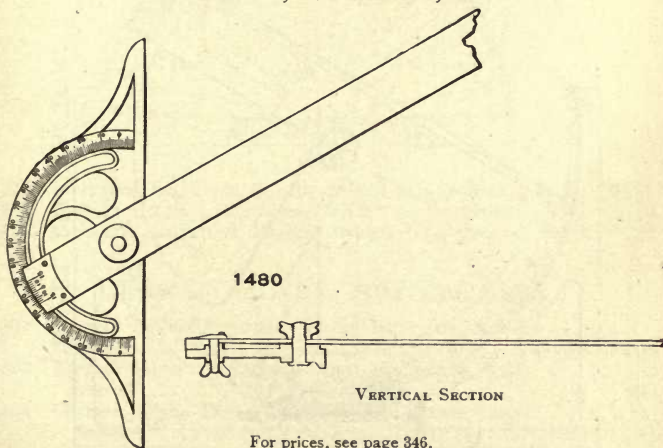

For prices, see page 346.

LIMB-PROTRACTOR

BRONZE HEAD, STEEL BLADE, VERNIER TO ONE MINUTE

No.			PRICE
1480	Limb-Protractor, with blade 24-inch.	Nickel-plated.....	\$ 8.00
1481	Limb-Protractor, with blade 30-inch.	Nickel-plated.....	8.75
1482	Limb-Protractor, with blade 36-inch.	Nickel-plated.....	9.50
1483	Limb-Protractor, with blade 42-inch.	Nickel-plated.....	10.25
1484	Limb-Protractor, with blade 48-inch.	Nickel-plated.....	11.50

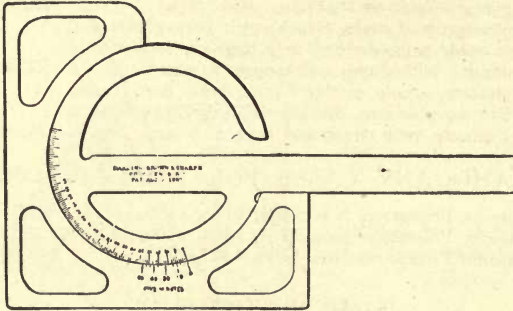

STEEL PROTRACTOR

1486

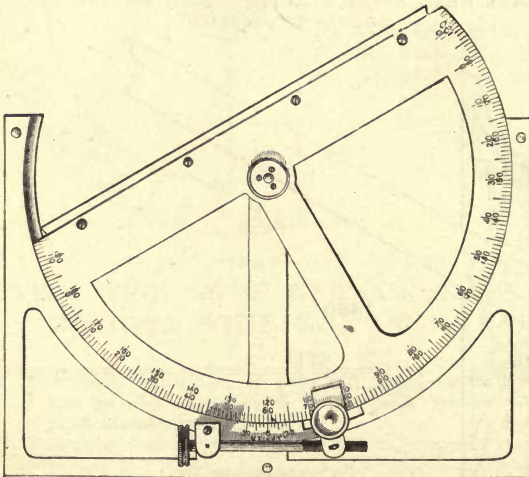

CROZET PROTRACTOR

1488

No.		PRICE	POST.
1486	Steel Protractor, divided to 1 degree, vernier to 5 minutes, 8½-inch blade. It is used with the T-rule or straight-edge. Very convenient in dividing circles, transferring angles, laying off angles each side of a line without resetting. In morocco case	\$ 7.75	\$0.35
1488	Crozet Protractor, German Silver, 8-inch, half-circle, half-degrees, vernier to 1 minute. In mahogany case.....	40.00	.70

The Crozet Protractor we can recommend as the best among the high-grade protractors.

It is used with the T-rule or straight-edge. The feather-edge is set to the starting-point and lines produced without puncturing the paper.

DUFFIELD PROTRACTOR

Made by W. & L. E. Gurley.

Made of transparent celluloid, with two parallel scales of twenty parts to the inch, so that the zero line can be set parallel to meridian lines drawn on the paper.

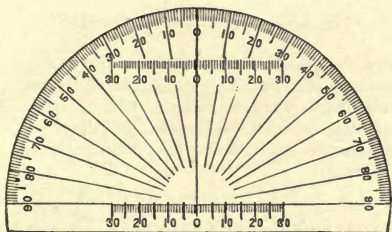

1490

1490	Protractor, half-circle, 6-inch, divided to ½ degrees..	\$3.00	\$0.12
1492	Protractor, half-circle, 9-inch, divided to ½ degrees..	3.50	.15
1494	Protractor, half-circle, 12-inch, divided to ¼ degrees..	4.00	.20

GERMAN SILVER PROTRACTORS

1500	German Silver Protractor, 4-inch, half-circle, whole degrees.....	\$0.50	\$0.03
1502	German Silver Protractor, 5-inch, half-circle, half-degrees.....	.85	.05
1503	German Silver Protractor, 6-inch, half-circle, half-degrees.....	1.00	.07

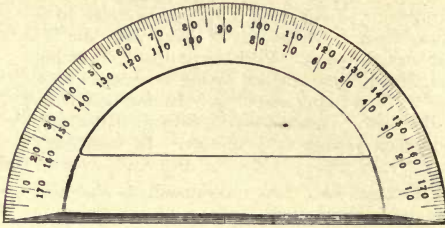

1510

No.		PRICE	POST.
1509	German Silver Protractor, 5-inch, half-circle, beveled edge, half-degrees	\$1.25	\$0.13
1510	German Silver Protractor, 6-inch, half-circle, beveled edge, half-degrees	1.50	.15
1511	German Silver Protractor, 7-inch, half-circle, beveled edge, half-degrees	2.00	.18

BRASS PROTRACTORS

1515	Brass Protractor, 3½-inch, half-circle, whole degrees	\$0.10	\$0.02
1516	Brass Protractor, 4 -inch, half-circle, whole degrees	.25	.03
1517	Brass Protractor, 4 -inch, half-circle, half-degrees..	.35	.03
1518	Brass Protractor, 5 -inch, half-circle, half-degrees..	.50	.05
1519	Brass Protractor, 6 -inch, half-circle, half-degrees..	.60	.07

OPAQUE WHITE CELLULOID PROTRACTORS

1525W	Celluloid Protractor, 6-inch, half-circle, beveled edge, half-degrees.....	\$3.00	\$0.13
1526W	Celluloid Protractor, 8-inch, half-circle, beveled edge, half-degrees	3.75	.15
1527W	Celluloid Protractor, 6-inch, whole circle, beveled edge, half-degrees.....	3.75	.18
1528W	Celluloid Protractor, 8-inch, whole circle, beveled edge, half-degrees.....	5.00	.20

TRANSPARENT CELLULOID PROTRACTORS

No.		PRICE	POST.
1532	Celluloid Protractor, 6-inch, half-circle, beveled edge, half-degrees.....	\$3.00	\$0.13
1533	Celluloid Protractor, 8-inch, half-circle, beveled edge, half-degrees.....	3.75	.15
1535	Celluloid Protractor, 6-inch, whole circle, beveled edge, half-degrees.....	3.75	.18
1536	Celluloid Protractor, 8-inch, whole circle, beveled edge, half-degrees.....	5.00	.25

TRANSPARENT HORN PROTRACTORS

1540	Horn Protractor, 4-inch, half-circle, whole degrees	\$ 0.15	\$0.02
1541	Horn Protractor, 5-inch, half-circle, half-degrees..	.25	.02
1542	Horn Protractor, 6-inch, half-circle, half-degrees..	.30	.03
1544	Horn Protractor, 8-inch, half-circle, half-degrees..	.60	.05
1547	Horn Protractor, 5-inch, whole circle, half-degrees	1.25	.12
1548	Horn Protractor, 6-inch, whole circle, half-degrees	1.50	.14

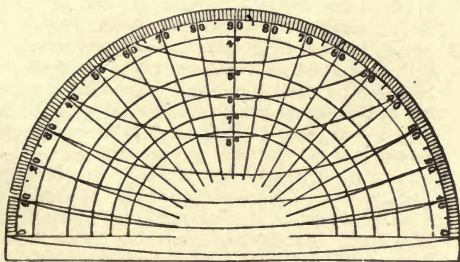

1550

1550	Railroad Curve Protractor, of horn, 8-inch, half-circle, half-degrees, with circular curves from $\frac{1}{2}$ degree to 8 degrees, to a scale of 400 feet to the inch.....	\$1.60	\$0.13
1551A	Ditto, of transparent celluloid.....	2.25	.18
1551B	Railroad Curve Protractor, of transparent celluloid, 10-inch, half-circle, half-degrees, with circular curves $1^\circ, 1\frac{1}{2}^\circ, 2^\circ, 2\frac{1}{2}^\circ, 3^\circ, 3\frac{1}{2}^\circ, 4^\circ, 5^\circ, 6^\circ, 7^\circ, 8^\circ, 10^\circ, 12^\circ, 14^\circ, 16^\circ, 18^\circ, 20^\circ$, to a scale of 100 feet to the inch.....	2.75	.25

PAPER PROTRACTORS

No.		PRICE	POST.
1552	Protractor, on Bristol Board, 5-inch, half-circle, half-degrees.....	\$0.10	\$0.02
1553	Protractor, on Bristol Board, 6-inch, half-circle, half-degrees.....	.15	.02
1554	Protractor, on Bristol Board, 5-inch, half-circle, half-degrees, and diagonal scale to inches and $\frac{1}{100}$ th, and millimeter.....	.15	.02
1555	Protractor, on Bristol Board, 8-inch, whole circle, half-degrees.....	.20	.04
1556	Protractor, on Bristol Board, 13-inch, whole circle, quarter-degrees.....	.40	.07
1558	Protractor, on Drawing Paper, 13-inch, whole circle, quarter-degrees.....	.30	.06
1559	Protractor, on Tracing Paper, 13-inch, whole circle, quarter-degrees.....	.25	.06

SCALES

IVORY PROTRACTOR-SCALES

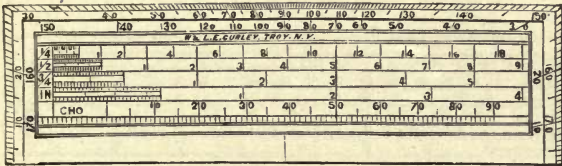

1560 FRONT SIDE

No.		PRICE	POST.
1560	Ivory Rectangular Protractor, 6 inches long, $1\frac{3}{4}$ inches wide, with scales as follows: front sides divided around edges from 0 to 180 degrees in single degrees, scales of $\frac{1}{4}$, $\frac{1}{2}$, $\frac{3}{4}$ and 1 inch to the foot, and scale of chords. Reverse side scales of 30, 35, 40, 45, 50 and 60 parts to the inch, scale of chords and diagonal scale of inches and $\frac{1}{100}$ ths.	\$1.50	\$0.12
1561	Ivory Rectangular Protractor, 6 inches long by $1\frac{3}{4}$ inches wide, with scales as follows: front side, the edge divided into single degrees from 0 to 180 degrees, scales of $\frac{1}{8}$, $\frac{1}{4}$, $\frac{3}{8}$, $\frac{1}{2}$, $\frac{5}{8}$, $\frac{3}{4}$, $\frac{7}{8}$, and 1 inch to the foot, and scale of chords. On the reverse side, scales of 30, 35, 40, 45, 50 and 60 parts to the inch, scale of chords and diagonal scale of $\frac{1}{100}$ ths.	2.00	.12
1563	Ivory Rectangular Protractor, 6 inches long by 2 inches wide, with scales as follows: front side, the edge divided in $\frac{1}{2}$ degrees from 0 to 180 degrees, scales of $\frac{1}{8}$, $\frac{1}{4}$, $\frac{3}{8}$, $\frac{1}{2}$, $\frac{5}{8}$, $\frac{3}{4}$, $\frac{7}{8}$, 1, $1\frac{1}{8}$, $1\frac{1}{4}$ inches to the foot, scale of chords, and line of 40 parts on lower edge. On the reverse side, scales of 20, 25, 30, 35, 40, 45, 50 and 60 parts to the inch, and diagonal scale of $\frac{1}{100}$ ths.	4.00	.13
1564	Ivory Rectangular Protractor, 6 inches long by $2\frac{1}{4}$ inches wide, with scales as follows: front side, the edge divided in $\frac{1}{2}$ degrees from 0 to 180 degrees, scales of $\frac{1}{8}$, $\frac{1}{4}$, $\frac{3}{8}$, $\frac{1}{2}$, $\frac{5}{8}$, $\frac{3}{4}$, $\frac{7}{8}$, 1, $1\frac{1}{8}$, $1\frac{1}{4}$, $1\frac{3}{8}$, $1\frac{1}{2}$ inches to the foot, scale of chords, and scale of 40 parts on the lower edge. Reverse side, scales of 10, 15, 20, 25, 30, 35, 40, 45, 50 and 60 parts to the inch, and diagonal scale of $\frac{1}{100}$ ths.	4.50	.13

FLAT BOXWOOD AND IVORY SCALES

No.		PRICE	POST.
1570	Boxwood Protractor, 6 inches long, $1\frac{3}{4}$ inches wide, divided to whole degrees, with scales $\frac{1}{4}$, $\frac{1}{2}$, $\frac{3}{4}$, 1 inch, diagonal scale and scale of chords.....	\$0.35	\$0.03
1572	Boxwood Scale, 6-inch, for school use.....	.15	.02

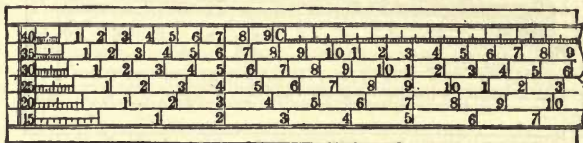

1573

1573	Ivory Scale, 6-inch, with diagonal and chain-scales..	.85	.03
1575	Boxwood Sector-Scale, 6-inch, opens to 12-inch....	1.00	.12
1576	Ivory Sector-Scale, 6-inch, opens to 12-inch.....	2.25	.15
1577	Boxwood Scale, 6-inch, divided $\frac{1}{8}$, $\frac{1}{4}$, $\frac{1}{2}$, 1 inch to the foot.....	.50	.03

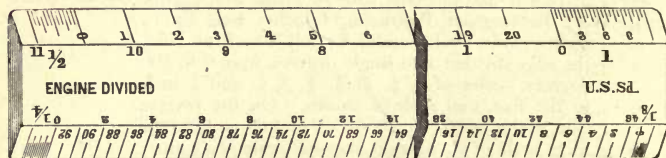

1578

1578	Boxwood Scale, 12-inch, divided $\frac{1}{8}$, $\frac{1}{4}$, $\frac{1}{2}$, 1 inch to the foot.....	.75	.06
1579	Boxwood Scale, 18-inch, divided $\frac{1}{8}$, $\frac{1}{4}$, $\frac{1}{2}$, 1 inch to the foot.....	1.50	.18
1580	Boxwood Scale, 24-inch, divided $\frac{1}{8}$, $\frac{1}{4}$, $\frac{1}{2}$, 1 inch to the foot.....	2.00	.22
1581	Ivory Scale, 6-inch, divided $\frac{1}{8}$, $\frac{1}{4}$, $\frac{1}{2}$, 1 inch to the foot.....	2.00	.12
1582	Ivory Scale, 12-inch, divided $\frac{1}{8}$, $\frac{1}{4}$, $\frac{1}{2}$, 1 inch to the foot.....	3.00	.14
1583	Boxwood Scale, 6-inch, divided $\frac{3}{8}$, $\frac{3}{4}$, $1\frac{1}{2}$, 3 inches to the foot.....	.50	.03

No.		PRICE	Post.
1584	Boxwood Scale, 12-inch, divided $\frac{3}{8}$, $\frac{3}{4}$, $1\frac{1}{2}$, 3 inches to the foot	\$0.75	\$0.06
1585	Boxwood Scale, 18-inch, divided $\frac{3}{8}$, $\frac{3}{4}$, $1\frac{1}{2}$, 3 inches to the foot,	1.50	.18
1586	Boxwood Scale, 24-inch, divided $\frac{3}{8}$, $\frac{3}{4}$, $1\frac{1}{2}$, 3 inches to the foot	2.00	.22
1587	Ivory Scale, 6-inch, divided $\frac{3}{8}$, $\frac{3}{4}$, $1\frac{1}{2}$, 3 inches to the foot	2.00	.12
1588	Ivory Scale, 12-inch, divided $\frac{3}{8}$, $\frac{3}{4}$, $1\frac{1}{2}$ 3 inches to the foot	3.00	.14
1590	Boxwood White Edge Scale, 6-inch, divided $\frac{1}{8}$, $\frac{1}{4}$, $\frac{1}{2}$, 1 inch to the foot.75	.03
1591	Boxwood White Edge Scale, 12-inch, divided $\frac{1}{8}$, $\frac{1}{4}$, $\frac{1}{2}$, 1 inch to the foot.	1.25	.14
1594	Boxwood White Edge Scale, 6-inch, divided $\frac{3}{8}$, $\frac{3}{4}$, $1\frac{1}{2}$, 3 inches to the foot.75	.03
1595	Boxwood White Edge Scale, 12-inch, divided $\frac{3}{8}$, $\frac{3}{4}$, $1\frac{1}{2}$, 3 inches to the foot	1.25	.14
1604	Boxwood Scale, 12-inch, one side rounded, the other flat, with the following scales, the graduations of which are all brought to the edge: $\frac{1}{16}$, $\frac{1}{8}$, $\frac{3}{16}$, $\frac{1}{4}$, $\frac{3}{8}$, $\frac{1}{2}$, $\frac{5}{8}$, $\frac{3}{4}$, $\frac{7}{8}$, 1, $1\frac{1}{4}$, $1\frac{1}{2}$, $1\frac{3}{4}$, 2, $2\frac{1}{2}$, and 3 inches to the foot, the first division of each scale subdivided into 12 parts.90	.06
1605	Ivory Scale, 12-inch, divided same as No. 1604	4.00	.14
1610	Boxwood School Rule, 12-inch, divided $\frac{1}{16}$ and $\frac{1}{8}$ of an inch10	.03
1611	Boxwood School Rule, 18-inch, divided $\frac{1}{8}$ of an inch, and with inlaid brass edges.35	.10
1612	School Rule, 12-inch, beveled edges, divided $\frac{1}{16}$ of an inch and millimeters.15	.05
1613	School Rule, 18-inch, beveled edges, divided $\frac{1}{16}$ of an inch and millimeters.35	.10

FLAT BOXWOOD CHAIN-SCALES

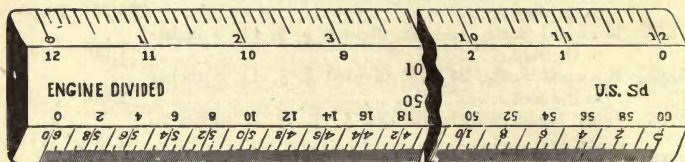

1618

No.		PRICE	POST.
1615	Boxwood Scale, 6-inch, divided 10 and 50 parts to the inch	\$0.50	\$0.03
1616	Boxwood Scale, 6-inch, divided 20 and 40 parts to the inch	.50	.03
1617	Boxwood Scale, 6-inch, divided 30 and 60 parts to the inch	.50	.03
1618	Boxwood Scale, 12-inch, divided 10 and 50 parts to the inch	.75	.06
1619	Boxwood Scale, 12-inch, divided 20 and 40 parts to the inch	.75	.06
1620	Boxwood Scale, 12-inch, divided 30 and 60 parts to the inch	.75	.06
1627	Boxwood Offset Scales, 2-inch, divided like Nos. 1615 to 1617, each	.40	.02
1632	Boxwood White Edge Scale, 12-inch, divided 10 and 50 parts to the inch	1.25	.14
1633	Boxwood White Edge Scale, 12-inch, divided 20 and 40 parts to the inch	1.25	.14
1634	Boxwood White Edge Scale, 12-inch, divided 30 and 60 parts to the inch	1.25	.14
1641	White Edge Offset Scales, 2-inch, divided like Nos. 1632 and 1634, each	.70	.02

FLAT METALLIC CHAIN-SCALES

A superior article, our own make, made of brass, and nickel-plated.
Divided on beveled edges.

1645	Flat Metal Scale, 12-inch, divided 10 and 50 parts to the inch	\$3.00	\$0.18
1646	Flat Metal Scale, 12-inch, divided 20 and 40 parts to the inch	3.00	.18
1647	Flat Metal Scale, 12-inch, divided 30 and 60 parts to the inch	3.75	.18
1648	Flat Metal Scale, 12-inch, divided 80 and 100 parts to the inch	5.00	.18

No.		PRICE	POST.
1649	Flat Metal Scale, 12-inch, divided 100 and 500 parts to the foot.....	\$3.00	\$0.18
1650	Flat Metal Scale, 30 centimeters, divided to millimeters and half-millimeters.....	3.75	.18

TRIANGULAR BOXWOOD SCALES



1656

1655	Triangular Boxwood Scale, 6-inch, divided $\frac{3}{8}$, $\frac{1}{4}$, $\frac{3}{8}$, $\frac{1}{2}$, $\frac{3}{4}$, 1, $1\frac{1}{2}$ and 3 inches to the foot, and one edge inches and 16ths.....	\$0.60	\$0.04
1656	Triangular Boxwood Scale, 12-inch, divided $\frac{1}{8}$, $\frac{1}{4}$, $\frac{3}{8}$, $\frac{1}{2}$, $\frac{3}{4}$, 1, $1\frac{1}{2}$, 2, 3 and 4 inches to the foot, and one edge inches and 16ths.....	1.00	.14
1657	Triangular Boxwood Scale, 18-inch, divided $\frac{1}{8}$, $\frac{1}{4}$, $\frac{3}{8}$, $\frac{1}{2}$, $\frac{3}{4}$, 1, $1\frac{1}{2}$, 2, 3 and 4 inches to the foot, and one edge inches and 16ths.....	2.50	.20
1658	Triangular Boxwood Scale, 24-inch, divided $\frac{1}{8}$, $\frac{1}{4}$, $\frac{3}{8}$, $\frac{1}{2}$, $\frac{3}{4}$, 1, $1\frac{1}{2}$, 2, 3 and 4 inches to the foot, and one edge inches and 16ths.....	4.25	.25

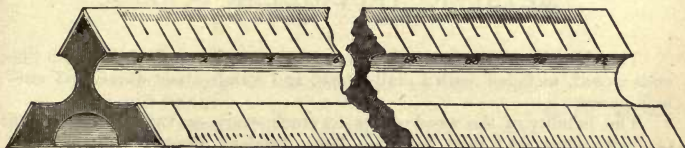

1661

1660	Triangular Boxwood Scale, 6-inch, divided 10, 20, 30, 40, 50 and 60 parts to the inch.....	.60	.04
1661	Triangular Boxwood Scale, 12-inch, divided 10, 20, 30, 40, 50 and 60 parts to the inch.....	1.00	.14
1662	Triangular Boxwood Scale, 18-inch, divided 10, 20, 30, 40, 50 and 60 parts to the inch.....	2.50	.20
1663	Triangular Boxwood Scale, 24-inch, divided 10, 20, 30, 40, 50 and 60 parts to the inch.....	4.25	.25

No.		PRICE	POST.
1665	Triangular Boxwood Scale, 12-inch, divided 20, 30, 40, 50, 60 and 80 parts to the inch.....	\$1.00	\$0.14
1668	Triangular Offset Scale, 2-inch, divided same as No. 1660.....	.60	.02
1670	Triangular Boxwood Scale, 12-inch, divided 100, 200, 300, 400, 500 and 600 parts to the foot.....	1.50	.14

TRIANGULAR BOXWOOD SCALES WITH WHITE EDGES

1674	White Edge Scale, 6-inch, divided same as No. 1655.....	\$1.50	\$0.11
1675	White Edge Scale, 12-inch, divided same as No. 1656.....	2.50	.14
1678	White Edge Scale, 6-inch, divided same as No. 1660.....	1.50	.11
1679	White Edge Scale, 12-inch, divided same as No. 1660.....	2.50	.14
1682	White Edge Scale, 12-inch, divided same as No. 1665.....	2.50	.14
1684	White Edge Scale, 12-inch, divided same as No. 1670.....	2.50	.14

METALLIC TRIANGULAR SCALES

The Metallic Triangular Scales are made of brass tubing with the ends closed, nicked with a dull finish, and weigh about three and one-half ounces.

The liability of the wood scales to crack, warp or twist, the chipping of their edges, and their variation from standard measurement, are well known to all who have used them. These objections have been overcome in the metallic scale.

1690	Metallic Triangular Scale, 12-inch, divided same as No. 1656.....	\$2.50	\$0.16
1692	Metallic Triangular Scale, 12-inch, divided same as No. 1660.....	2.50	.16
1694	Metallic Triangular Scale, 12-inch, divided same as No. 1665.....	2.50	.16
1698	Guard for Triangular Scale (preventing errors).....	.20	.02

METRIC SCALES AND RULES

No.		PRICE	POST.
1700	Flat Boxwood Scale, 20 centimeters, divided to millimeters and $\frac{1}{2}$ millimeters.....	\$0.60	\$0.04
1701	Flat Boxwood Scale, 30 centimeters, divided to millimeters and $\frac{1}{2}$ millimeters.....	.75	.06
1702	Flat Boxwood Scale, 50 centimeters, divided to millimeters and $\frac{1}{2}$ millimeters.....	1.50	.18
1703	Flat White Edge Scale, 20 centimeters, divided to millimeters and $\frac{1}{2}$ millimeters.....	1.00	.12
1704	Flat White Edge Scale, 30 centimeters, divided to millimeters and $\frac{1}{2}$ millimeters.....	1.25	.14
1706	Triangular Boxwood Scale, 20 centimeters, divided to .01, .02, .03, .05, .025, .0125.....	.75	.12
1707	Triangular Boxwood Scale, 30 centimeters, divided to .01, .02, .03, .05, .025, .0125.....	1.00	.14
1710	Triangular Boxwood Scale, 30 centimeters, divided to millimeters and $\frac{1}{2}$ millimeters, also to 10ths, 12ths and 16ths of inches, and 100ths of a foot...	2.00	.14
1712	Triangular White Edge Scale, 30 centimeters, divided same as No. 1706.....	2.50	.14
1714	Triangular White Edge Scale, 30 centimeters, divided same as No. 1710.....	3.00	.14
1718	Flexible Wood Rule, four feet, eight fold, divided to millimeters and 16ths of inches, spring-joints....	.50	.05
1719	Flexible Wood Rule, same as No. 1718, and with white enamel finish.....	.60	.05

PAPER SCALES

1724	Paper Scale, $1\frac{1}{4}$ -inch wide, 12 inches long, graduations on one edge inches and 10ths, and the other feet and 100ths.....	\$0.10	\$0.02
1725	Paper Scale, same as No. 1724, edges 20 and 40 parts to the inch.....	.10	.02
1726	Paper Scale same as No. 1724, edges 16 and 48 parts to the inch.....	.10	.02
	Paper Scales, printed on card-paper, 18 inches long, for architects and engineers, as follows:		
1727	Series A contains 6 scales, one each divided to $\frac{1}{4}$, $\frac{1}{2}$, $\frac{3}{4}$, 1, $1\frac{1}{2}$, and 3 inches to the foot, each scale....	.20	.04
1728	Series B contains 6 scales, one each divided $\frac{3}{32}$, $\frac{1}{8}$, $\frac{3}{16}$, $\frac{5}{16}$, $\frac{3}{8}$, and $\frac{7}{8}$ -inch to the foot, each scale.....	.20	.04
1729	Series C contains 6 scales, one each divided to 10, 20, 30, 40, 50 and 60 parts to the inch, each scale....	.20	.04

THACHER'S CALCULATING INSTRUMENT

No.		PRICE	POST.
1730	Thacher's Calculating Instrument, with cylinder 18 inches long. Performs a great variety of useful calculations with rapidity and accuracy. In mahogany box and with instruction book	\$35.00	
1731	Thacher's Calculating Instrument, same as No. 1730, and with 3-inch reading glass sliding on brass bar, adjustable to any part of the instrument and for focus	45.00	

CIRCULAR SLIDE-RULES

1732	Crockett Slide-Rule. Applicable to any width of roadbed, any center height, any length, any side slope ratio, and to sections determined by any number of levels, without requiring the plotting of the end sections. 16½ inches diameter, on heavy cardboard	\$4.00	\$0.35
1734	Rudiger Slide-Rule. Applicable to use with center height, and the surface slope measured in degrees. 16½ inches diameter, on heavy cardboard	4.00	.35
Descriptive circular of the Crockett and Rudiger Slide-Rules mailed on application.			

BOXWOOD AND IVORY POCKET RULES, ETC.

1735	Boxwood Rule, one foot, four fold, 8ths and 16ths of inches	\$0.10	\$0.03
1736	Boxwood Rule, one foot, four fold, edge-plates, 8ths and 16ths of inches18	.03
1737	Boxwood Rule, one foot, four fold, brass edges, bound, 8ths and 16ths of inches30	.04
1740	Boxwood Rule, two feet, four fold, 8ths and 16ths of inches15	.05
1741	Boxwood Rule, two feet, four fold, edge-plates, 8ths, 10ths, 12ths and 16ths of inches, and drafting-scales25	.05
1742	Boxwood Rule, two feet, four fold, brass edges, bound, 8ths 10ths, 12ths and 16ths of inches, and drafting scales50	.06
1743	Boxwood Rule, two feet, four fold, edge-plates, 8ths, 10ths, 12ths and 16ths of inches, and drafting scales, and inside beveled edges50	.06
1745	Boxwood Caliper-Rule, one foot, four fold, edge-plates, 8ths, 10ths, 12ths and 16ths of inches40	.04

No.		PRICE	POST.
1747	Ivory Rule, one foot, four fold, edge-plates, 8ths, 10ths, 12ths and 16ths of inches	\$1.40	\$.12
1748	Ivory Rule, one foot, four fold, edge-plates, 8ths, 10ths, 12ths and 16ths of inches and 100ths of a foot.	1.85	.12
1749	Ivory Rule, one foot, four fold, German silver edges, bound, divided like No. 1747.	2.50	.13
1750	Ivory Caliper-Rule, one foot, four fold, edge-plates, divided like No. 1748	2.15	.13
1751	Ivory Caliper-Rule, one foot, four fold, German silver edges, bound, divided like No. 1747.	2.85	.13
1753	Ivory Rule, two feet, four fold, edge-plates, 8ths, 10ths, 12ths, and 16ths of inches, and 100ths of a foot.	4.25	.15
1754	Ivory Rule, two feet, four fold, German silver edges, bound, 8ths, 10ths, 12ths, and 16ths of inches, and drafting-scales.	5.00	.15
1755A	Flexible Wood Rule, four feet, eight fold, divided to 16ths of an inch and 100ths of a foot, with spring-joints50	.05
1755B	Flexible Wood Rule, same as No. 1755A, and with white enamel finish.75	.05
1755C	Flexible Wood Rule, six feet, twelve fold, divided same as No. 1755A.75	.08
1755D	Flexible Wood Rule, same as No. 1755C, and with white enamel finish.90	.08
1756A	Flexible Wood Rule, four feet, eight fold, divided to 16ths of inches, and with spring-joints.50	.05
1756B	Flexible Wood Rule, same as No. 1756A, and with white enamel finish.60	.05
1757	Flexible Wood Rule, four feet, eight fold, divided to 16ths and 20ths of inches, and with spring-joint.50	.05
1758	Boxwood Shrink-Rule, divided to 8ths, 10ths, 12ths and 16ths of inches. Either $24\frac{2}{10}$, $24\frac{1}{4}$, $24\frac{3}{8}$, or $24\frac{1}{2}$ =24 inches. Each style	1.20	.18
1760	Boxwood Combination Rule, one foot, two fold. It combines in itself a Carpenter's Rule, Spirit-Level, Square, Plumb, Bevel, Indicator, Brace-Scale, Drafting-Scale of equal parts, T-Square, Protractor, Right-angle Triangle, etc.	2.00	.15

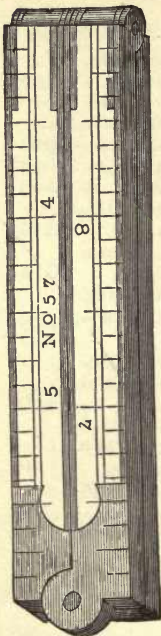

1737

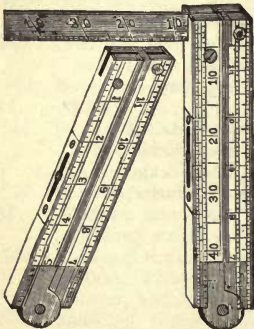

1760



1762

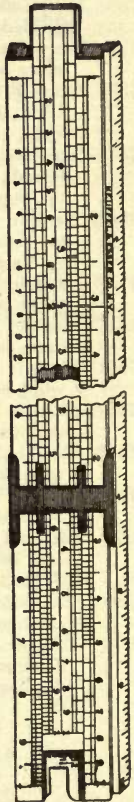

1764

For prices, see pages 358, 359 and 361.

BOXWOOD SLIDE-RULES. SEE PAGE 360

No.		PRICE	POST.
1761	Mannheim Slide-Rule, not adjustable, 10-inch, divided on white facings, with glass indicator and directions.....	\$3.00	\$0.15
1762	Faber's Slide-Rule and Calculating Scale, 10½-inch, with glass indicator and directions.....	3.75	.20
1763	Students' Slide-Rule, for beginners, 10-inch, with indicator and directions	1.00	.15
1764A	Engineers' Adjustable Mannheim Slide-Rule, 8-inch, divided on white facings, with glass indicator and directions.....	4.50	.15
1764B	Engineers' Adjustable Mannheim Slide-Rule, 10-inch, divided on white facings, with glass indicator and directions.....	4.50	.15
1764C	Engineers' Adjustable Mannheim Slide-Rule, 16-inch, divided on white facings, with glass indicator and directions	10.00	.30
1765	Duplex Slide-Rule, 10-inch, divided on white facings, with glass indicator, Arithmetical slide and directions.....	7.00	.15
1767	Duplex Slide-Rule, 10-inch, divided on white facings, with glass indicator and both Arithmetical and Trigonometrical slides and directions.....	8.50	.20
1768	Stadia Slide-Rule, 20-inch, divided on white facings. This rule is designed to solve the equations generally used in stadia measurements.....	12.50	.35
1769	Engineers' Adjustable Mannheim Slide-Rule, 20-inch, divided on white facings, with glass indicator and directions.....	12.50	.35

For Treatises on Slide-Rules, see pages 455 and 457.

STANDARD STEEL RULES

No.		PRICE	Post.	No.		PRICE	Post.
1770	3-inch	\$0.35	\$0.02	1775	18-inch	\$2.00	\$0.20
1772	6-inch65	.05	1776	24-inch	2.75	.30
1774	12-inch	1.25	.15	1777	36-inch	7.00	.50

These rules are divided on four edges in parts of inches as follows :
10, 20, 50, 100 ; 12, 24, 48 ; 16, 32, 64 ; 8.

STANDARD METRIC STEEL RULES

1780	$\frac{1}{10}$ -meter	\$0.45	\$0.03	1783	$\frac{1}{2}$ -meter	\$2.00	\$0.22
1781	$\frac{1}{5}$ -meter85	.14	1784	1-meter	8.00	.55
1782	$\frac{3}{10}$ -meter	1.25	.16				

These rules are divided to millimeters and half-millimeters.

TRIANGULAR STEEL RULES

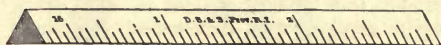

1785

1785	3-inch	\$0.50	\$0.03	1787	6-inch	\$1.00	\$0.13
1786	4-inch70	.05	1788	12-inch	2.00	.15

These rules are divided on three edges in parts of inches as follows :
20, 50, 100 ; 12, 24, 48 ; 16, 32, 64.

SQUARE STEEL RULES

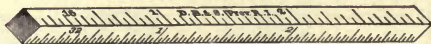

1790

1790	3-inch	\$0.45	\$0.03	1792	6-inch	\$0.90	\$0.13
1791	4-inch60	.05				

These rules are divided on four edges in parts of inches as follows :
16, 32, 64, 100.

STEEL STRAIGHT-EDGES. SQUARE EDGES

		NICKEL-				NICKEL-			
		PLAIN	PLATED	POST		PLAIN	PLATED	POST	
1800	15-inch ..	\$0.90	\$1.15	\$0.15	1804	36-inch ..	\$3.00	\$3.50	\$0.40
1801	18-inch ..	1.00	1.25	.18	1805	42-inch ..	4.00	4.50	.50
1802	24-inch ..	1.50	1.90	.24	1806	48-inch ..	6.00	6.60	.65
1803	30-inch ..	2.25	2.70	.30	1807	60-inch ..	8.00	8.70	...

STEEL STRAIGHT-EDGES, NICKEL PLATED

ONE EDGE BEVELED

No.		PRICE	Post.	No.		PRICE	Post.
1810	18-inch.....	\$2.00	\$0.18	1813	36-inch.....	\$5.00	\$0.40
1811	24-inch.....	3.00	.24	1814	42-inch.....	6.50	.50
1812	30-inch.....	4.00	.30	1815	48-inch.....	8.00	.65

MAHOGANY STRAIGHT-EDGES, AMBER-LINED

ONE EDGE BEVELED



1820

1820	18-inch.....	\$0.90	\$0.06	1823	36-inch.....	\$1.90	\$0.25
1821	24-inch.....	1.10	.16	1824	42-inch.....	2.50	.32
1822	30-inch.....	1.25	.18	1825	48-inch.....	3.00	.40

MAHOGANY STRAIGHT-EDGES, EBONY-LINED

SQUARE EDGES



1830

1830	24-inch.....	\$0.50	\$0.08	1833	42-inch.....	\$1.00	\$0.32
1831	30-inch.....	.60	.12	1834	48-inch.....	1.35	.40
1832	36-inch.....	.80	.15	1835	60-inch.....	2.00

HARD RUBBER STRAIGHT-EDGES

SQUARE EDGES

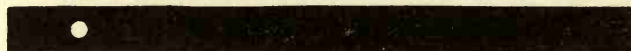

1840

1840	18-inch.....	\$0.50	\$0.06	1843	36-inch.....	\$1.35	\$0.25
1841	24-inch.....	.75	.08	1844	42-inch.....	1.75	.32
1842	30-inch.....	1.00	.18	1845	48-inch.....	2.25	.40

HARDWOOD STRAIGHT-EDGES ONE EDGE BEVELED



1850

No		PRICE	Post.	No.		PRICE	Post.
1850	18-inch	\$0.20	\$0.06	1854	42-inch	\$0.50	\$0.24
1851	24-inch25	.08	1855	48-inch65	.32
1852	30-inch30	.12	1856	60-inch	1.00	...
1853	36-inch40	.15	1857	72-inch	1.25	...

T-SQUARES

MAHOGANY T-SQUARES WITH AMBER EDGES AND FIXED HEAD

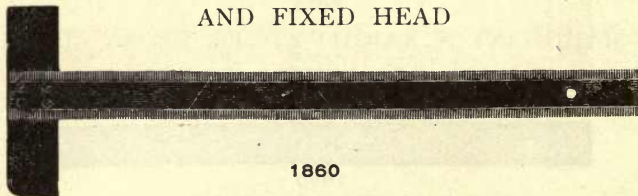

1860

1860	18-inch	\$1.10	\$0.25	1863	36-inch	\$2.15	\$0.50
1861	24-inch	1.50	.35	1864	42-inch	2.50	.55
1862	30-inch	1.85	.45	1865	48-inch	3.00	...

MAHOGANY T-SQUARES WITH AMBER EDGES AND SHIFTING HEAD

1870	18-inch	\$1.90	\$0.30	1873	36-inch	\$3.20	\$0.55
1871	24-inch	2.45	.40	1874	42-inch	3.60	.60
1872	30-inch	2.80	.50	1875	48-inch	4.20	...

RUBBER BLADE T-SQUARES, HARDWOOD HEAD, FIXED

1880	18-inch	\$0.90	\$0.25	1882	30-inch	\$1.60	\$0.45
1881	24-inch	1.25	.35	1883	36-inch	2.00	.50

RUBBER BLADE T-SQUARES, HARDWOOD HEAD, SHIFTING

No.		PRICE	Post.	No.		PRICE	Post.
1888	18-inch.....	\$1.60	\$0.30	1890	30-inch.....	\$2.50	\$0.50
1889	24-inch.....	2.00	.40	1891	36-inch.....	3.00	.55

STEEL BLADE T-SQUARES, NICKEL-PLATED, WITH FIXED JAPANED IRON HEAD

1896	18-inch.....	\$3.00	\$0.35	1898	30-inch.....	\$4.50	\$0.45
1897	24-inch.....	3.50	.40	1899	36-inch.....	5.50	.50

STEEL BLADE T-SQUARES, NICKEL-PLATED, WITH SHIFTING JAPANED IRON HEAD

1902	18-inch.....	\$4.25	\$0.45	1904	30-inch.....	\$5.75	\$0.55
1903	24-inch.....	5.00	.50	1905	36-inch.....	6.75	.60

HARDWOOD T-SQUARES, FIXED HEAD

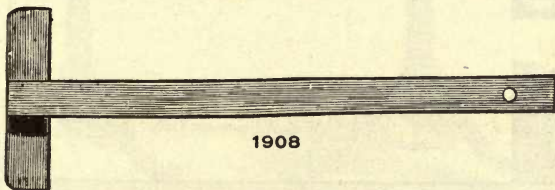

1908	15-inch.....	\$0.30	\$0.15	1911	30-inch.....	\$0.50	\$0.45
1909	20-inch.....	.40	.25	1912	40-inch.....	.75	.60
1910	25-inch.....	.45	.35	1913	50-inch.....	1.00

HARDWOOD T-SQUARES, SHIFTING HEAD

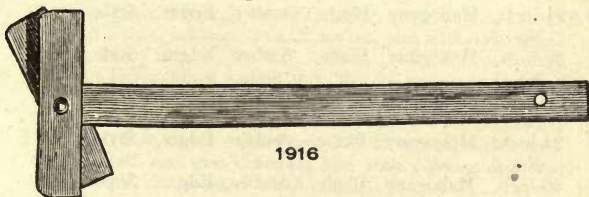

1916	15-inch.....	\$0.80	\$0.20	1919	30-inch.....	\$1.00	\$0.50
1917	20-inch.....	.90	.30	1920	40-inch.....	1.25	.65
1918	25-inch.....	.95	.40	1921	50-inch.....	1.50

No.		PRICE	POST.
1924	Mahogany T-Square, 30-inch ebony-lined blade and fixed head.....	\$1.20	\$0.45
1926	Mahogany T-Square, 30-inch ebony-lined blade and shifting head.....	2.00	.50

T-SQUARES WITH DEANE'S PATENT SWIVEL AND ADJUSTMENT

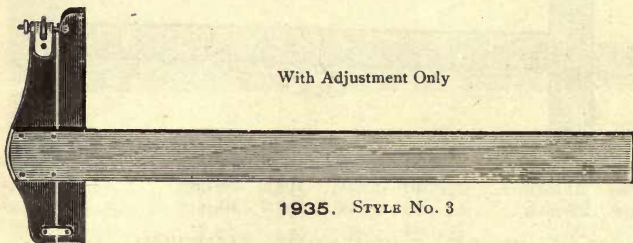
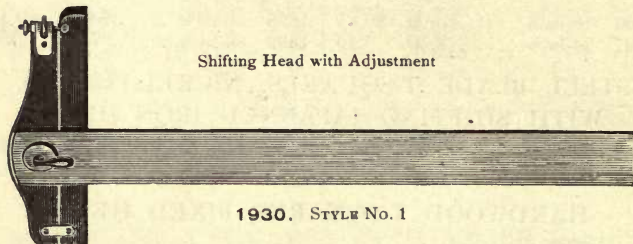

1930	24-inch, Mahogany Blade, Amber Edges, Style No. 1.....	\$3.65	\$0.40
1931	30-inch, Mahogany Blade, Amber Edges, Style No. 1.....	4.15	.45
1932	36-inch, Mahogany Blade, Amber Edges, Style No. 1.....	4.75	.50
1935	24-inch, Mahogany Blade, Amber Edges, Style No. 3.....	3.15	.40
1936	30-inch, Mahogany Blade, Amber Edges, Style No. 3.....	3.65	.45
1937	36-inch, Mahogany Blade, Amber Edges, Style No. 3.....	4.25	.50

DRAWING-TABLES

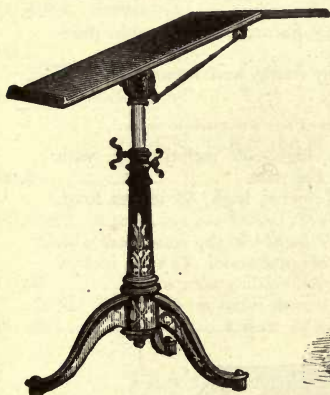

1954

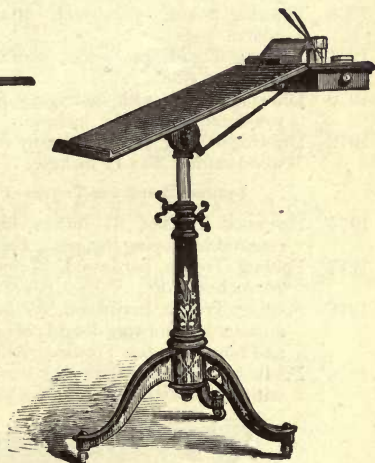

1956

No.		PRICE
1953	Drawing-Table, ash top, 24 x 22 inches	\$ 8.00
1954	Drawing-Table, ash top, 24 x 22 inches, and with instrument shelf, 24 x 7 inches.....	9.00
1956	Drawing-Table, black walnut top, 26 x 22 inches, instrument shelf, 26 x 7 inches, two instrument drawers, ornamented stand	12.00
1958	Drawing-Table, black walnut top, 26 x 22 inches, with instrument shelf and two drawers, and with folding arm and plain shelf, ornamented stand.....	17.00

These Tables are adjustable for horizontal and angular motion and for heights about 30 to 44 inches. The shelves and drawers remain level when the top is inclined. They are mounted on an iron stand with casters.

DRAWING-BOARDS AND TRESTLES

No.		PRICE
1960	Drawing-Board, pinewood, 14 x 10 inches.....	\$0.35
1962	Drawing-Board, pinewood, 20 x 15 inches, tongue and groove ends.....	.75
1964	Drawing-Board, pinewood, 28 x 20 inches, tongue and groove ends.....	1.50
1966	Drawing-Board, pinewood, 40 x 28 inches, tongue and groove ends.....	2.50
1967	Drawing-Board, pinewood, 55 x 33 inches, dovetailed cleats on under side.....	8.00
1970	Drawing-Board, with mahogany frame, and removable pinewood center, 18 x 13 inches.....	3.00
1972	Drawing-Board, with mahogany frame, and removable pinewood center, 25 x 17 inches.....	4.00
Drawing-Boards and Trestles of any size made to order.		
1975	Pinewood Horses, 37 inches high, 35 inches long, with removable sloping ledges. Per pair.....	5.00
1977	Folding Trestle, hardwood, 37 inches high, 33 inches long, 26 inches wide.....	8.00
1978	Folding Trestle, hardwood, 37 inches high, combined with adjustable Drawing-Board of pinewood, 42 x 31 inches, and hinged to the Trestle. All folding compactly.....	13.00
1979	Folding Trestle and Drawing-Board, same as No. 1978, but with the Drawing-Board 55 x 33 inches.....	16.00

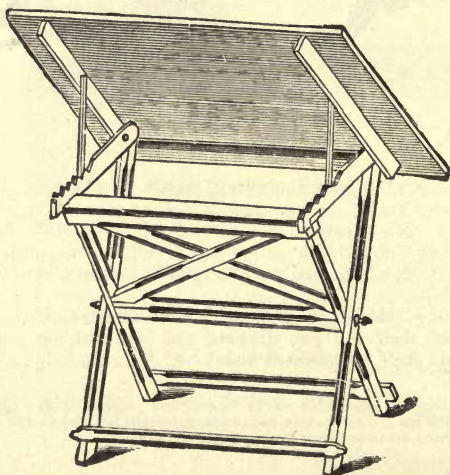

1978

TRIANGLES

OPEN STEEL TRIANGLES. NICKEL-PLATED

30° x 60° x 90°

No.		PRICE	Post.	No.		PRICE	Post.
1982	6-inch.....	\$3.20	\$0.15	1986	10½-inch.....	\$4.25	\$0.25
1984	8-inch.....	3.85	.20	1989	15-inch.....	6.50	.40

45° x 45° x 90°

1992	6½-inch.....	3.50	.18	1996	10-inch.....	5.50	.35
1994	8-inch.....	4.25	.25	1998	12-inch.....	6.50	.45

OPEN GERMAN SILVER TRIANGLES

30° x 60° x 90°

2002	6-inch.....	\$2.50	\$0.15	2006	10-inch.....	\$4.00	\$0.25
2004	8-inch.....	3.00	.20	2008	12-inch.....	5.00	.30

45° x 45° x 90°

2012	6-inch.....	2.75	.18	2016	10-inch.....	5.00	.35
2014	8-inch.....	4.00	.25	2018	12-inch.....	6.50	.45

TRANSPARENT AMBER TRIANGLES

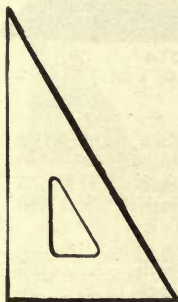

2022
30° x 60° x 90°

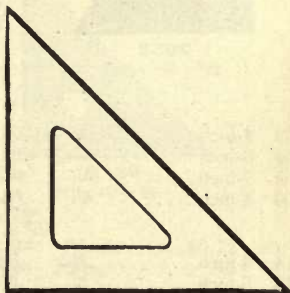

2036
45° x 45° x 90°

For prices, see page 370.

TRANSPARENT AMBER TRIANGLES

30° x 60° x 90°

No.		PRICE	POST.	No.		PRICE	POST.
2022	4-inch	\$0.25	\$0.03	2028	10-inch	\$0.75	\$0.08
2024	6-inch40	.04	2030	12-inch	1.00	.18
2026	8-inch55	.06	2032	14-inch	1.65	.20

45° x 45° x 90°

2036	4-inch35	.04	2042	8-inch75	.08
2038	6-inch55	.05	2044	10-inch	1.10	.18
2040	7-inch65	.07	2046	12-inch	1.65	.20

HARD RUBBER TRIANGLES



2052

30° x 60° x 90°

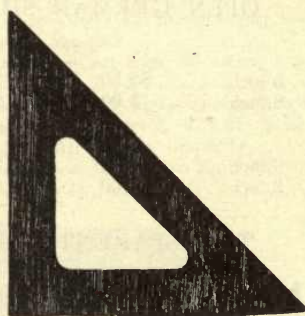

2074

45° x 45° x 90°

30° x 60° x 90°

2052	4-inch	\$0.20	\$0.03	2058	10-inch	\$0.65	\$0.08
2054	6-inch30	.04	2060	12-inch90	.10
2055	7-inch35	.05	2062	14-inch	1.25	.20
2056	8-inch45	.06	2064	16-inch	1.50	.25

45° x 45° x 90°

2074	4-inch25	.04	2078	8-inch65	.08
2075	5-inch35	.05	2080	10-inch95	.10
2076	6-inch45	.05	2082	12-inch	1.30	.20
2077	7-inch50	.07	2084	14-inch	1.85	.25

Other sizes of Amber or Rubber Triangles to order.

HARDWOOD TRIANGLES, OPEN CENTER,
FRAMED



2092

30° x 60° x 90°

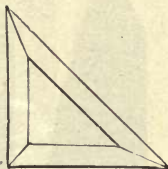

2108.

45° x 45° x 90°

30° x 60° x 90°

No.		PRICE	POST.	No.		PRICE	POST.
2092	6-inch	\$0.20	\$0.04	2098	12-inch	\$0.40	\$0.10
2094	8-inch	.25	.06	2100	14-inch	.50	.12
2096	10-inch	.30	.08	2102	16-inch	.60	.18

45° x 45° x 90°

2107	5-inch	.20	.05	2110	8-inch	.35	.08
2108	6-inch	.25	.05	2112	10-inch	.40	.10
2109	7-inch	.30	.08	2114	12-inch	.50	.12

HARDWOOD TRIANGLES, PLAIN

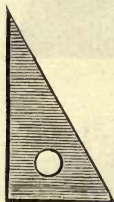

2120

30° x 60° x 90°

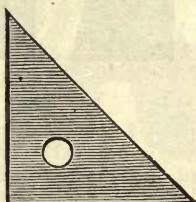

2130

45° x 45° x 90°

30° x 60° x 90°

2120	4-inch	\$0.08	\$0.03	2124	8-inch	\$0.12	\$0.06
2122	6-inch	.10	.04	2126	10-inch	.15	.08

45° x 45° x 90°

2130	4-inch	.10	.04	2132	6-inch	.15	.05
2131	5-inch	.12	.05	2134	8-inch	.18	.08

HARD RUBBER LETTERING-TRIANGLES

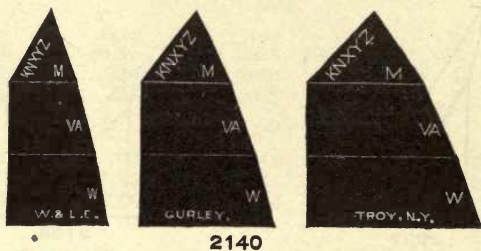

2140

No.		PRICE	POST.
2140	Lettering-Triangles for Block Letters, $3\frac{1}{2}$ -inch, three in a set. Per set.....	\$1.35	\$0.12

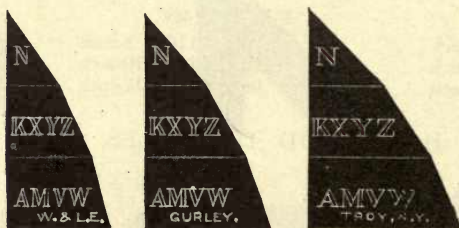

2145

2145	Lettering-Triangles for Shaded Letters, $3\frac{1}{2}$ -inch, three in a set. Per set.....	1.20	.12
2146	Hard Rubber Lettering-Templats, three in a set. Per set.....	1.50	.15
2147	Transparent Amber Lettering-Templats, three in a set. Per set.....	2.00	.15

HARD RUBBER TRIANGLES FOR EMBANKMENTS AND ROOF PITCHES

2150	Rubber Triangles, for slopes $\frac{1}{4}$ to 1, $\frac{1}{2}$ to 1, $\frac{3}{4}$ to 1, 1 to 1, $1\frac{1}{4}$ to 1, $1\frac{1}{2}$ to 1, 2 to 1. Per set of seven..	\$3.00	\$0.16
------	---	--------	--------

SECTION-LINERS

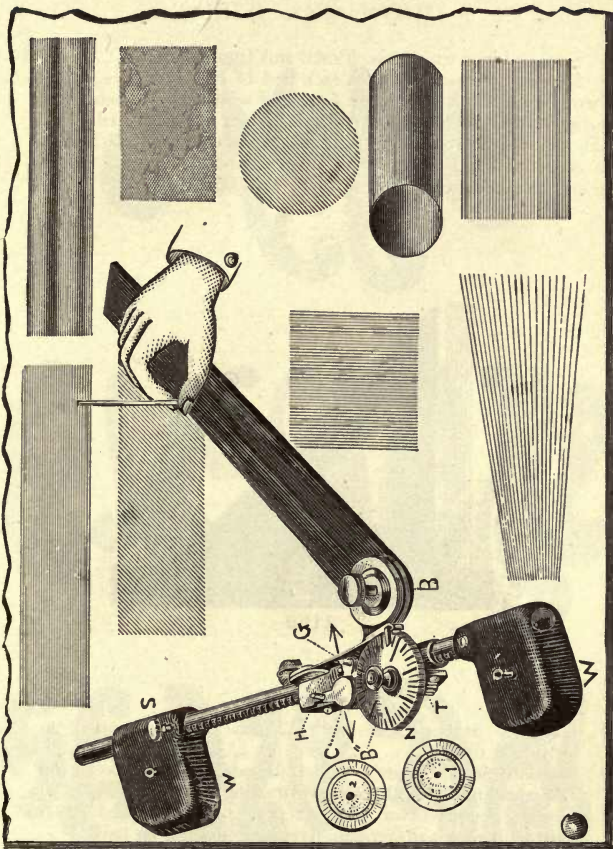

2155. For price, see page 374.

This Section-Liner is positive in all its motions, being operated by a rack and pinion movement. The rack-rod passes through two heavy weights and is held securely by clamp screws. Two needle-pointed pins aid to hold the weights in place when necessary. Lines can be drawn at any angle, in any direction, and on any part of the board.

SECTION-LINERS

No.	PRICE
2155 Section-Liner with 12-inch rack and 12-inch blade.....	\$6.50
2156 Section-Liner with 14-inch rack and 14-inch blade.....	7.50

Two plain notched wheels are furnished with each instrument for producing 64 and 100 parts to the inch. Extra wheels for either 10, 12, 20, 24, 40, 48 or 50 parts to the inch will be furnished for \$1.50 each. These notched wheels when graduated on the face for ruling and measuring combined will cost \$2.25 each.

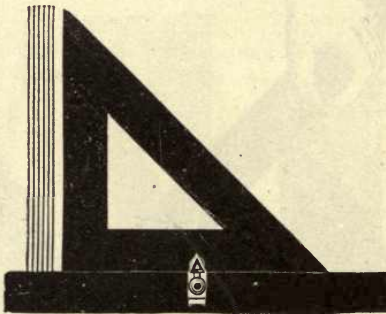

2168

No.	PRICE	POST.
2168 Marion's Section-Liner with 7-inch triangle and 10-inch ruler.....	\$2.00	\$0.20
2170 Standard Section-Liner. Especially adapted for school use and mechanical sectional drawing.....	1.75	.20
2171 Casey's Section-Liner with amber triangle, boxwood straight-edge and German silver mountings. By two scales and verniers on the plates, distances are measured to $\frac{1}{100}$ th inch or $\frac{1}{10}$ th millimeter.....	3.50	.20
2175 Terry's Positive Section-Liner with 12-inch ruler and brace attachment.....	10.00	
2177 Both's Section-Liner and Scale-Divider, with $14\frac{3}{4}$ -inch base, 9-inch rack, arm 10-inch beyond protractor.....	12.00	.40

IRREGULAR CURVES OF HARD RUBBER,
AMBER AND WOOD

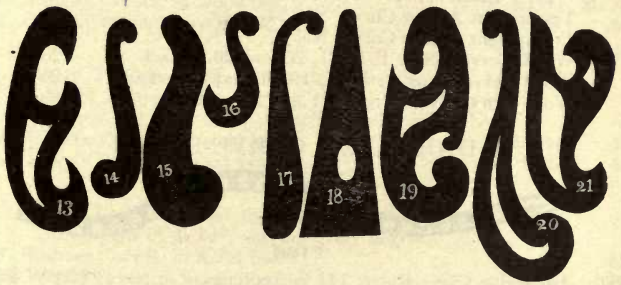

IRREGULAR CURVES OF HARD RUBBER, AMBER AND WOOD

See patterns on page 375.

No.		PRICE	POST.
2180	Hard Rubber Curves, Nos. 1, 2, 14, 16, 17, 22, 25 and 26. Each.....	\$0.35	\$0.03
	Hard Rubber Curves, Nos. 5, 15, 18, 21 and 23. Each.....	.40	.03
	Hard Rubber Curves, Nos. 3, 4, 13, 19, 20 and 24. Each.....	.50	.05
	Hard Rubber Curve, No. 27.....	.75	.08
	Hard Rubber Curve, No. 28.....	2.25	.18
	Hard Rubber Curve, Logarithmic Spiral, No. 29....	1.50	.13
2182	Transparent Amber Curves, Nos. 1, 2, 5, 16, 22, 25 and 26. Each.....	.45	.03
	Transparent Amber Curves, Nos. 3, 4, 13, 19 and 20. Each.....	.60	.05
	Transparent Amber Curve, No. 24.....	.75	.05
	Transparent Amber Curve, No. 27.....	.90	.08
2184	Wood Curves, Nos. 1, 5, 21, 25 and 26. Each....	.20	.03
	Wood Curves, Nos. 3, 4, 13, 19, 20 and 24. Each..	.25	.05
	Wood Curve, No. 27.....	.35	.08

ADJUSTABLE CURVE-RULER



2186

2186	Adjustable Curve-Ruler, 14½ inches long.....	\$2.25	\$0.15
2187	Adjustable Curve-Ruler, 30 inches long.....	3.30	.35

These rulers can be instantly adjusted and retained to any form of curve.

This tool is recommended by architects and draftsmen, and meets a long-felt want. It is well made, neatly finished and nickel-plated.

ELLIPSES, HYPERBOLAS AND PARABOLAS

2190	Hard Rubber Ellipses, 6 in a set, 2 to 4½-inch.		
	Per set.....	\$1.50	\$0.13
2191	Hard Rubber Ellipses, 10 in a set, 1½ to 6-inch.		
	Per set.....	2.50	.16
2194	Wood Ellipses, 6 in a set, 2 to 4½-inch. Per set....	1.25	.13
2195	Wood Ellipses, 10 in a set, 1½ to 6-inch. Per set...	2.00	.16
2200	Wood Hyperbolas, 8 in a set, 2 to 5½-inch. Per set.	1.50	.15
2204	Wood Parabolas, 8 in a set, 1½ to 5½-inch. Per set..	1.50	.15

RAILROAD CURVES

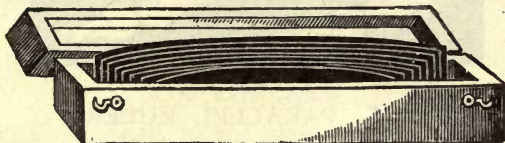

2210

No.		PRICE	POST.
	Set of 10 Curves, cut to a scale of inches, from 12 to 120 inches radius, varying every 12 inches.		
2210	Rubber Curves, in wood box.....	\$6.00	\$0.30
2211	Wood Curves, in wood box.....	3.75	.30
	Set of 24 Curves, cut to a scale of inches, from 1½ to 24 inches radius, varying every ½ inch up to 10 inches and then every 2 inches up to 24 inches.		
2214	Rubber Curves, in wood box.....	13.50	.40
2215	Wood Curves, in wood box.....	8.00	.40
	Set of 10 Curves, cut to a scale of 40 feet to the inch, from 1° to 10°, varying every degree.		
2218	Rubber Curves, in wood box.....	6.00	.30
2219	Wood Curves, in wood box.....	3.75	.30
	Set of 20 Curves, cut to a scale of 40 feet to the inch, from 1° to 20°, varying every degree.		
2222	Rubber Curves, in wood box.....	12.00	.35
2223	Wood Curves, in wood box.....	7.50	.35
	Set of 12 Curves, cut to a scale of 100 feet to the inch, from 1° to 12°, varying every degree.		
2226	Rubber Curves, in wood box.....	8.50	.30
2227	Wood Curves, in wood box.....	5.50	.30
	Set of 20 Curves, cut to a scale of 400 feet to the inch, from 30' to 10°, varying every 30 minutes.		
2238	Rubber Curves, in wood box.....	12.00	.35
2239	Wood Curves, in wood box.....	7.50	.35

PARALLEL RULERS



2250

EBONY PARALLEL RULERS

No.		PRICE	POST.	No.		PRICE	POST.
2250	6-inch.....	\$0.30	\$0.04	2253	15-inch.....	\$1.00	\$0.18
2251	9-inch.....	.50	.06	2254	18-inch.....	1.25	.20
2252	12-inch.....	.75	.08	2255	24-inch.....	2.00	.24

HARD RUBBER PARALLEL RULERS

2260	6-inch.....	\$0.75	\$0.04	2262	12-inch.....	\$1.25	\$0.16
2261	9-inch.....	1.00	.06	2263	15-inch.....	1.50	.18

EBONY PARALLEL RULERS, ON ROLLERS

2270	9-inch.....	\$2.75	\$0.20	2272	15-inch.....	\$4.00	\$0.30
2271	12-inch.....	3.25	.25	2273	18-inch.....	5.00	.35

HARD RUBBER PARALLEL RULERS, ON ROLLERS

2275	9-inch.....	\$3.50	\$0.20	2277	15-inch.....	\$5.00	\$0.30
2276	12-inch.....	4.25	.25	2278	18-inch.....	6.00	.35

EBONY PARALLEL RULERS, ON ROLLERS

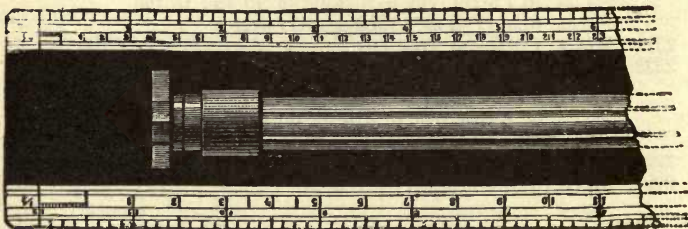
WITH WHITE EDGES, DIVIDED $\frac{1}{8}$, $\frac{1}{4}$, $\frac{1}{2}$, 1 INCH TO THE FOOT

2280

2280	12-inch.....	\$5.00	\$0.25	2282	18-inch.....	\$7.50	\$0.35
2281	15-inch.....	6.50	.30				

BRASS PARALLEL RULERS, ON ROLLERS

No.		PRICE	Post.	No.		PRICE	Post.
2285	9-inch.....	\$7.25	\$0.30	2287	15-inch.....	\$10.00	\$0.50
2286	12-inch.....	8.50	.40	2288	18-inch.....	12.00	

GERMAN SILVER PARALLEL RULERS,
ON ROLLERS

2292	9-inch.....	\$8.50	\$0.30	2294	15-inch.....	\$12.00	\$0.50
2293	12-inch.....	10.00	.40	2295	18-inch.....	15.00	

PANTOGRAPHS FOR ENLARGING OR
REDUCING DRAWINGS

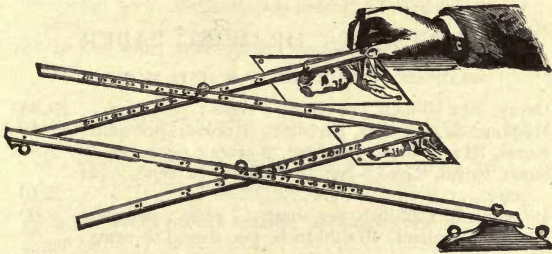

2300

2300	Pantograph, hardwood, brass mountings, with arms 21 inches long	\$1.75	\$0.30
2302	Pantograph, hardwood, nickel-plated mountings, with arms 18 to 20 inches long.....	2.50	.30
2304	Pantograph, hardwood, brass mountings, with arms 22 inches long.....	3.50	
2306	Pantograph, hardwood, brass mountings, with arms 41 inches long.....	5.00	

DRAWING-PAPER

ARCHITECTS' PAPER FOR PLANS

WHITE, STRONG, SMOOTH SURFACE

No.		PRICE	POST.
2350	Medium, 23 x 18-inch, per sheet, 6 cents ; per quire..	\$1.25	\$0.48
2352	Super Royal, 28 x 20-inch, per sheet, 8 cents ; per quire.....	1.75	.65
2355	30 inches wide, per roll of 10 yards.....	1.25	.40
2356	36 inches wide, per roll of 10 yards.....	1.50	.50
2357	42 inches wide, per roll of 10 yards.....	1.75	.60

WHATMAN'S DRAWING-PAPER

SELECTED, BEST QUALITY, GRAINED SURFACE

2360	Demy, 20 x 15-inch, per sheet, 5 cents ; per quire..	\$0.95	\$0.28
2361	Medium, 22 x 17-inch, per sheet, 7 cents ; per quire.	1.40	.36
2362	Royal, 24 x 19-inch, per sheet, 9 cents ; per quire...	1.80	.48
2363	Super Royal, 27 x 19-inch, per sheet, 10 cents ; per quire.....	2.10	.53
2365	Imperial, 30 x 22-inch, per sheet, 17 cents ; per quire	3.00	.66
2368	Double Elephant, 40 x 26-inch, per sheet, 25 cents ; per quire.....	5.75	1.28

WHATMAN'S DRAWING-PAPER

MOUNTED ON MUSLIN

2370	Royal, 24 x 19-inch, per sheet.....	\$0.39	\$0.10
2372	Imperial, 30 x 22-inch, per sheet.....	.48	.13
2374	Double Elephant, 40 x 27-inch, per sheet.....	.72	.18

BRISTOL BOARD DRAWING-PAPER

2380	Patent Office Bristol Board, 15 x 10-inch, per sheet, 6 cents ; per dozen.....	\$0.60	\$0.20
2381	Bristol Board, 20 x 15-inch, per sheet, 12 cents ; per dozen.....	1.20	.45
2385	Patent Office Bristol Board, printed with border, etc., 15 x 10-inch, per sheet, 10 cents ; per dozen.....	.85	.15

DETAIL DRAWING-PAPER, CREAM BUFF TINT

SUPERIOR QUALITY, IN ROLLS OF 30 TO 40 POUNDS

No.		PRICE	POST.
2389	30 inches wide, per pound, 29 cents ; per yard.....	\$0.13	\$0.10
2390	36 inches wide, per pound, 29 cents ; per yard.....	.15	.12
2391	42 inches wide, per pound, 29 cents ; per yard.....	.20	.20

BLEACHED MANILLA PAPER

FOR WORKSHOP DRAWINGS, BEST AMERICAN MAKE, IN ROLLS OF ABOUT
50 POUNDS

2395	36 inches wide, medium, per pound, 12 cents ; per yard.....	\$0.08	\$0.12
2396	42 inches wide, medium, per pound 12 cents ; per yard.....	.10	.14
2397	48 inches wide, medium, per pound, 12 cents ; per yard.....	.12	
2398	54 inches wide, medium, per pound, 12 cents ; per yard.....	.15	

AMERICAN WHITE ROLL DRAWING-PAPER

VERY STRONG AND OF EXCELLENT QUALITY, IN ROLLS OF
ABOUT 40 POUNDS

2410	36 inches wide, smooth surface, per pound, 45 cents ; per yard.....	\$0.25	\$0.12
2411	42 inches wide, smooth surface, per pound, 45 cents ; per yard.....	.30	.14
2413	62 inches wide, smooth surface, per pound, 45 cents ; per yard.....	.50	
2414	72 inches wide, smooth surface, per pound, 50 cents ; per yard.....	.75	

EXCELSIOR WHITE ROLL DRAWING-PAPER

IN ROLLS OF ABOUT 40 POUNDS

2420	36 inches wide, grained surface, per pound, 40 cents ; per yard.....	\$0.20	\$0.12
2421	42 inches wide, grained surface, per pound, 40 cents ; per yard.....	.24	.14

Small quantities of paper must be put on a wooden roller when sent by mail. Several yards can be put on a single roller, with but little extra for postage. The pound price for papers Nos. 2389 to 2434 applies only to full rolls.

BEST EGGSHELL DRAWING-PAPER

IN ROLLS OF ABOUT 40 POUNDS

No.		PRICE	POST.
2430	36 inches wide, pebbled surface, per pound, 50 cents ; per yard	\$0.33	\$0.13
2431	42 inches wide, pebbled surface, per pound, 50 cents ; per yard38	.15
2434	58 inches wide, pebbled surface, per pound, 50 cents ; per yard50	
2435	58 inches wide, thick, pebbled surface, per pound, 50 cents ; per yard65	

MOUNTED DRAWING-PAPER

WHITE, MOUNTED ON MUSLIN, IN ROLLS OF 10 YARDS

2450	American, 36 inches wide, smooth surface, per roll, \$6.80 ; per yard	\$0.85	\$0.25
2451	American, 42 inches wide, smooth surface, per roll, \$8.20 ; per yard	1.00	.30
2453	American, 62 inches wide, smooth surface, per roll, \$13.25 ; per yard	1.60	
2454	American, 72 inches wide, smooth surface, per roll, \$18.00 ; per yard	2.25	
2460	Eggshell, 36 inches wide, pebbled surface, per roll, \$7.50 ; per yard	1.00	.25
2461	Eggshell, 42 inches wide, pebbled surface, per roll, \$8.85 ; per yard	1.10	.30
2463	Eggshell, 58 inches wide, medium thick, pebbled surface, per roll, \$11.75 ; per yard	1.40	
2464	Eggshell, 58 inches wide, thick, pebbled surface, per roll, \$12.60 ; per yard	1.50	
Large pieces, for City, County or State Maps, mounted to order.			
2467	Paper Cloth, 38 inches wide, smooth surface, per roll of 10 yards, \$4.00 ; per yard45	.20

DRAWING-PARCHMENT

2468	38 inches wide, medium, per roll of 20 yards, \$3.00 ; per yard	\$0.20	\$0.12
2469	38 inches wide, thick, per roll of 10 yards, \$3.20 ; per yard45	.15

TRACING-PAPER

No.		PRICE	POST.
2470	Pellucid, common, 21 inches wide, per yard, 5 cents ; per roll of 20 yards.....	\$ 0.75	\$0.18
2471	Pellucid, common, 42 inches wide, per yard, 10 cents ; per roll of 20 yards.....	1.50	.40
2472	Vegetable, 30 inches wide, per yard, 10 cents ; per roll of 20 yards.....	1.50	.40
2474	Bank Note, 36 inches wide, per yard, 10 cents ; per roll of 20 yards.....	1.62	.40
2476	Parchment, 40 inches wide, per yard, 25 cents ; per roll of 20 yards.....	4.00	.60
2478	Bond, 42 inches wide, per yard, 15 cents ; per roll of 20 yards.....	2.25	.45
2479	Manilla, common, 48 inches wide, per yard, 7 cents ; per roll of 20 yards.....	1.00	.50
2480	Vegetable, 25 x 19 inches, per sheet, 10 cents ; per quire.....	2.00	.20
2482	Flaxine, 31 x 21 inches, per sheet, 12 cents ; per quire.....	2.50	.25
2484	Bond, 21 x 16 inches, per sheet, 6 cents ; per quire..	1.00	.20
2486	Bond, 30 x 19 inches, per sheet, 8 cents ; per quire..	1.40	.30
2493	Pounce Powder, in tin shaker, for Tracing-paper or Tracing-cloth, each.....	.15	.07

IMPERIAL TRACING-CLOTH

IN ROLLS OF 24 YARDS, FACE GLAZED AND BACK DULL

2495	30 inches wide, per yard, 40 cents ; per roll.....	\$ 8.10	\$0.70
2496	36 inches wide, per yard, 45 cents ; per roll.....	9.00	1.10
2497	42 inches wide, per yard, 60 cents ; per roll.....	12.10	1.25
2498	48 inches wide, per yard, 80 cents ; per roll.....	16.00	
2499	54 inches wide, per yard, 85 cents ; per roll.....	17.00	

PREPARED BLUE-PRINT PAPER

BEST QUALITY ; READY FOR IMMEDIATE USE

2506	Sensitized Paper, 24 inches wide, per yard, 15 cents ; per roll of 10 yards.....	\$ 1.20	\$0.40
2508	Sensitized Paper, 30 inches wide, per yard, 18 cents ; per roll of 10 yards.....	1.50	.50
2510	Sensitized Paper, 36 inches wide, per yard, 20 cents ; per roll of 10 yards.....	1.65	.60
2512	Sensitized Paper, 42 inches wide, per yard, 22 cents ; per roll of 10 yards.....	1.80	.70
2515	White Ink, for altering Blue-prints, per bottle.....	.20	.06
2516	Red Ink, for altering Blue-prints, per bottle.....	.20	.06

BLUE-PRINT PAPER, NOT PREPARED

No		PRICE	Post.
2520	24 inches wide, per roll of 10 yards.....	\$0.80	\$0.35
2522	30 inches wide, per roll of 10 yards.....	1.00	.45
2524	36 inches wide, per roll of 10 yards.....	1.15	.55
2526	24 inches wide, per roll of 50 yards.....	3.20	
2528	30 inches wide, per roll of 50 yards.....	4.00	
2530	36 inches wide, per roll of 50 yards.....	4.75	

PRINT FRAMES AND BATH TRAYS

PRINT FRAMES

MADE OF HARDWOOD, WITH BRASS MOUNTINGS, CUSHION AND PLATE GLASS

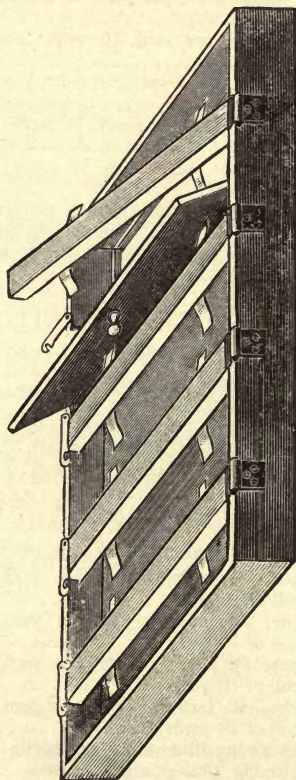

2534

For prices, see page 385.

PRINT FRAMES AND BATH TRAYS

No.		PRICE
2534	Print Frame, complete with Plate Glass and Cushion, 24 x 20 inches, clear exposure.....	\$ 9.00
2536	Print Frame, complete with Plate Glass and Cushion, 30 x 24 inches, clear exposure.....	12.00
2538	Print Frame, complete with Plate Glass and Cushion, 42 x 30 inches, clear exposure.....	22.00
2540	Zinc Bath Tray, for washing copies, 24 x 20 inches..	3.75
2542	Zinc Bath Tray, for washing copies, 30 x 24 inches..	4.50
2544	Zinc Bath Tray, for washing copies, 42 x 30 inches..	6.00
	Felt, $\frac{1}{4}$ inch thick, for Print Frames, per square foot,	.25

THE BLUE PROCESS OF COPYING TRACINGS

Special attention is directed to this easy process of copying tracings, and its great value to all Engineers, Architects and Mechanical Draftsmen is fully recognized.

If not convenient to procure a Print Frame, blue-prints can be made readily by following these directions:—

- 1 Provide a flat board as large as the tracing which is to be copied.
- 2 Lay on this board a cushion of blanket or felt about $\frac{1}{4}$ -inch thick, to give a slightly yielding backing for the paper.
- 3 Lay on the blanket the prepared paper with the sensitive side uppermost.
- 4 Lay on this paper the tracing, making it as smooth as possible, so as to insure a perfect contact with the paper.
- 5 Lay on the tracing a plate of clear glass, which should be heavy enough to press the tracing close down upon the paper. Ordinary plate-glass, one quarter of an inch in thickness, is sufficient.
- 6 Expose the whole to a clear sunlight by pushing it out on a shelf from a window, or in any other convenient way, from four to six minutes [in winter, six to ten minutes]. If a clear sky only can be had, the exposure must be continued from twenty to thirty minutes; and under a cloudy sky from sixty to ninety minutes may be needed, the shade depending on the time.
- 7 Remove the prepared paper and wash it freely for one or two minutes in clear water, and hang it by one corner to dry.

Too light a blue means under-exposure, and too dark a blue is over-exposure.

TIN TUBES WITH SCREW TOPS

FOR HOLDING PREPARED PAPER, TRACINGS, DRAWINGS, ETC.

No.		PRICE	POST.
2546	Plain Tin Tube, screw top, 24 x 2 $\frac{1}{4}$ inches	\$0.80	\$0.30
2547	Plain Tin Tube, screw top, 30 x 2 $\frac{1}{4}$ inches95	.35
2548	Plain Tin Tube, screw top, 36 x 2 $\frac{1}{4}$ inches	1.00	.40
2549	Plain Tin Tube, screw top, 42 x 2 $\frac{1}{4}$ inches	1.10	.45

TOWNSHIP PLOTTING-PAPER

2550	Township Plotting-paper, Rulings 6 x 6 inches, blocks 1 inch square, per quire	\$1.00	\$0.10
2552	Township Plotting-paper, Rulings 12 x 12 inches, blocks 2 inches square, per quire	2.00	.25
2553	Township Plotting-paper, Rulings 18 x 15 inches, per quire	3.00	.30

CROSS-SECTION SKETCH BLOCKS

24 SHEETS

2554	Sketch Block, 7 x 5 inches, 24 sheets, ruled $\frac{1}{10}$ of an inch	\$0.75	\$0.06
2555	Sketch Block, 10 x 7 inches, 24 sheets, ruled $\frac{1}{10}$ of an inch	1.25	.12
2557	Sketch Block, 18 x 13 cm., metric ruling75	.06
2558	Sketch Block, 26 x 18 cm., metric ruling	1.25	.12

PLAIN SKETCH BLOCKS

EACH BLOCK CONSISTS OF 32 SHEETS OF BEST QUALITY WHATMAN'S DRAWING-PAPER

2560	Sketch Block, 7 x 5 inches, unbound	\$0.50	\$0.08
2561	Sketch Block, 10 x 7 inches, unbound90	.16
2563	Sketch Block, 14 x 10 inches, unbound	1.60	.40
2565	Sketch Block, 20 x 14 inches, unbound	3.00	.70
2570	Sketch Block, 7 x 5 inches, bound	1.00	.12
2571	Sketch Block, 10 x 7 inches, bound	1.50	.32
2573	Sketch Block, 14 x 10 inches, bound	2.40	.56
2575	Sketch Block, 20 x 14 inches, bound	4.50	

The unbound blocks have a stiff pasteboard backing.

The bound blocks have cloth sides and leather back, with a portfolio and loop for pencil inside. The portfolio will last for a number of blocks.

PROFILE-PAPERS

Sheets: Lines printed in green.

Continuous: Lines printed in green or red.

Continuous on tracing-paper or tracing-cloth: Lines printed in orange.



PROFILE-PAPER, PLATE A

PLATE A. Rulings 4 x 20 to the inch

No.		PRICE	Post.
2580	Plate A, sheet 42 x 15 inches, per quire.....	\$8.50	\$0.75
2581	Plate A, sheet 42 x 15 inches, per sheet.....	.40	.05
2584	Plate A, continuous, 20 inches wide, 50 yards in roll, per yard.....	.24	.05
2586	Plate A, continuous, 20 inches wide, mounted on muslin, 20 yards in roll, per yard.....	.65	.08
2588	Plate A, continuous, 20 inches wide, on tracing-paper, 50 yards in roll, per yard.....	.24	.05
2589	Plate A, continuous, 20 inches wide, on tracing-cloth, 20 yards in roll, per yard.....	.75	.08

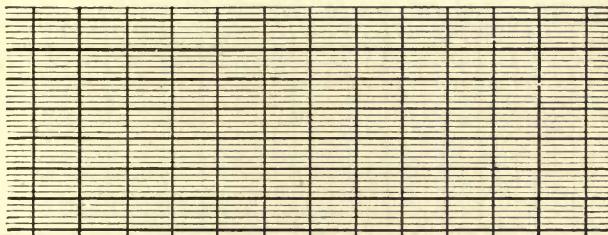

PROFILE-PAPER, PLATE B. See page 388.

PROFILE-PAPERS

PLATE B. Rulings 4 x 30 to the inch.

No.		PRICE	POST.
2595	Plate B, sheet 42 x 13½ inches, per quire.....	\$8.50	\$0.75
2596	Plate B, sheet 42 x 13½ inches, per sheet.....	.40	.05
2600	Plate B, continuous, 20 inches wide, 50 yards in roll, per yard.....	.24	.05
2602	Plate B, continuous, 20 inches wide, mounted on muslin, 20 yards in roll, per yard.....	.65	.08
2604	Plate B, continuous, 20 inches wide, on tracing paper, 50 yards in roll, per yard.....	.24	.05
2605	Plate B, continuous, 20 inches wide, on tracing cloth, 20 yards in roll, per yard.....	.75	.08

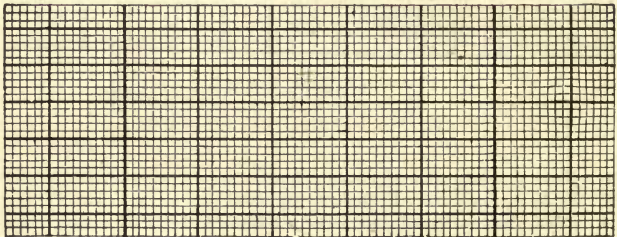

PROFILE-PAPER, METRIC

2610	METRIC. In continuous roll, rulings 50 centimeters wide, in millimeters, with each fifth millimeter, each centimeter, and each decimeter proportionally heavier than the millimeters, 50 yards in roll, per yard24	.05
2612	Metric, continuous, mounted on muslin, 20 yards in roll, per yard60	.08

CROSS-SECTION PAPERS

Sheets : Lines printed in green.

Continuous : Lines printed in green.

Continuous on tracing paper or tracing cloth : Lines printed in orange.

No.		PRICE	POST.
2620	Cross-section Paper, Plate C, rulings 20 x 16 inches, 8 feet to inch, per sheet, 20 cents ; per quire	\$3.50	\$0.40

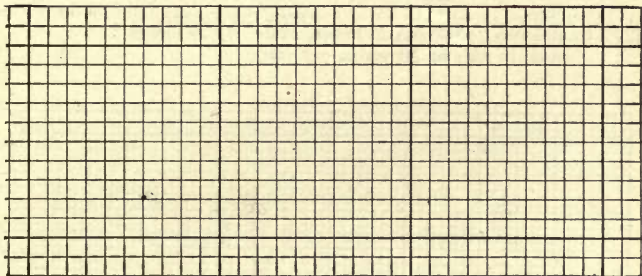

PLATE F. 10 feet to one inch.

2621	Cross-section Paper, Plate F, rulings 20 x 16 inches, 10 feet to inch, per sheet, 20 cents ; per quire . . .	3.50	.40
2622	Continuous Cross-section Paper, Plate F, 20 inches wide, in rolls of 50 yards, per yard24	.05
2623A	Continuous Cross-section Paper, Plate F, 20 inches wide, ruled 10 feet to inch on tracing-paper, in rolls of 50 yards, per yard24	.05
2623B	Continuous Cross-section, Plate F, 20 inches wide, ruled 10 feet to inch on tracing-cloth, in rolls of 20 yards, per yard75	.08

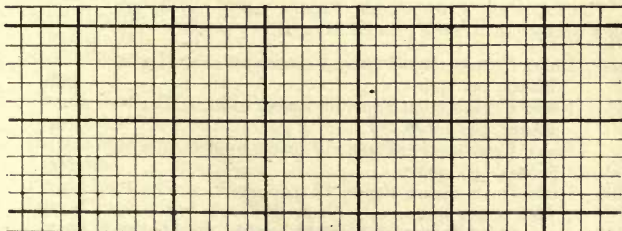
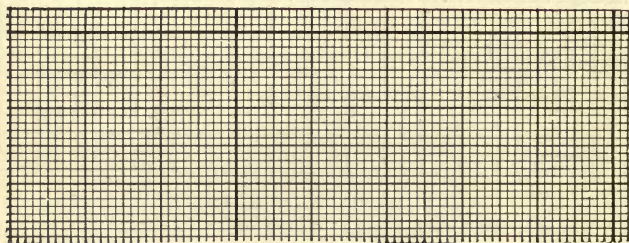

PLATE G. See page 390.

No.		PRICE	POST.
2624	Cross-section Paper, Plate G, rulings 20 x 16 inches, 10 feet to inch, every fifth line heavy, per sheet, 20 cents; per quire	\$3.50	\$0.40
2625	Cross-section Paper, Plate G, printed on Parchment Tracing-Paper, in sheets, 20 x 16 inches, per sheet, 20 cents; per quire.....	3.50	.25
2626	Cross-section Paper, Plate H, rulings, 20 x 16 inches, 16 feet to inch, per sheet, 20 cents; per quire.....	3.50	.40
2627	Continuous Cross-section Paper, Plate H, 20 inches wide, in rolls of 50 yards, per yard.....	.24	.05



MILLIMETER

2630	Cross-section Paper, Metric, rulings every millimeter, size of sheet, 50 x 40 centimeters, per sheet, 20 cents; per quire.....	3.50	.40
2631	Continuous Cross-section Paper, Metric, rulings every millimeter, 50 centimeters wide, in rolls of 50 yards, per yard.....	.24	.05

The following Cross-section Papers, being ruled, are much cheaper than those printed from copper plates :

2635	Ruled Cross-section Paper, 4 spaces to inch, 21 x 16 inches, per quire.....	1.00	.35
2636	Ruled Cross-section Paper, 8 spaces to inch, 21 x 16 inches, per quire.....	1.00	.35
2637	Ruled Cross-section Paper, 10 spaces to inch, 21 x 16 inches, per quire.....	1.00	.35
2638	Ruled Cross-section Paper, 12 spaces to inch, 21 x 16 inches, per quire.....	1.00	.35
2645	Crowell's Adhesive Tape, $\frac{3}{4}$ -inch wide, for binding and mending drawings, per box of 50 feet.....	.25	.05

THUMB TACKS AND HORN CENTERS



2680 TO 2690

2708

No.		PRICE	POST.
2680	Brass Thumb Tacks, round head, $\frac{1}{4}$ -inch diam., per doz.	\$0.10	\$0.02
2681	Brass Thumb Tacks, round head, $\frac{3}{8}$ -inch diam., per doz.15	.02
2682	Brass Thumb Tacks, round head, $\frac{1}{2}$ -inch diam., per doz.25	.02
2684	German Silver Thumb Tacks, round head, $\frac{3}{8}$ -inch diam., per doz.25	.02
2685	German Silver Thumb Tacks, round head, $\frac{1}{2}$ -inch diam., per doz.30	.02
2686	German Silver Thumb Tacks, round head, $\frac{5}{8}$ -inch diam., per doz.45	.03
2689	German Silver Thumb Tacks, round head, superior, $\frac{1}{2}$ -inch diam., per doz.70	.02
2690	German Silver Thumb Tacks, round head, superior, $\frac{5}{8}$ -inch diam., per doz.90	.03
2692	Steel Thumb Tacks, common, $\frac{3}{8}$ -inch diam., per doz.08	.02
2693	Steel Thumb Tacks, common, $\frac{3}{8}$ -inch diam., per box of 100.55	.08
2694	Steel Thumb Tacks, common, $\frac{9}{16}$ -inch diam., per doz.12	.02
2695	Steel Thumb Tacks, common, $\frac{9}{16}$ -inch diam., per box of 100.80	.10
2697	Steel Thumb Tacks, superior, $\frac{5}{16}$ -inch diam., per doz.80	.02
2700	Thumb Tack Lifter and Paper-knife20	.02
2703	Brass Paper Fasteners, prongs $\frac{1}{2}$ -inch, per doz.05	.02
2705	Brass Paper Fasteners, prongs $\frac{1}{2}$ -inch, in box, per hundred.25	.08
2707	Horn Center, plain.10	.01
2708	Horn Center with German silver rim.50	.01
2710	Handy Paper Cutter, brass mounted, for cutting drawings from the board.35	.03

CONTINUOUS PROFILE-BOOKS

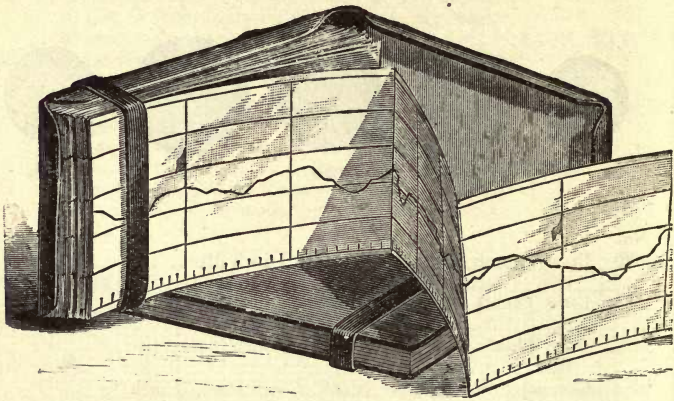

2715

These books are for field or office purposes, being printed on a tough thick paper, mounted upon a continuous piece of muslin and bound in book form with flexible morocco covers, convenient for the pocket. Each page will contain a profile of three thousand feet in length, so that each folio will contain an average section of a road as usually laid out for construction. Railroad and other engineers will find them very useful. The rulings correspond to our large profile-plates A and B.

No.		PRICE	POST.
2715	Plate A, about $8\frac{1}{2}$ x 6 inches, profile 12 miles.....	\$2.00	\$0.15
2716	Plate A, about $8\frac{1}{2}$ x 6 inches, profile 25 miles.....	3.25	.18
2717	Plate A, about $8\frac{1}{2}$ x 6 inches, profile 50 miles.....	5.25	.20
2718	Plate A, about $8\frac{1}{2}$ x 6 inches, profile 100 miles.....	9.50	.28
2720	Plate B, about 8 x $5\frac{1}{4}$ inches, profile 12 miles.....	2.00	.13
2721	Plate B, about 8 x $5\frac{1}{4}$ inches, profile 25 miles.....	3.25	.15
2722	Plate B, about 8 x $5\frac{1}{4}$ inches, profile 50 miles.....	5.25	.18
2723	Plate B, about 8 x $5\frac{1}{4}$ inches, profile 100 miles.....	9.50	.25

PLAT AND PROFILE-BOOKS

These books are $9\frac{1}{2}$ x $4\frac{1}{4}$ inches, oblong, with flexible morocco covers, containing 36 profile-pages, plate B, and the opposite pages are blank for plats, etc.

2724A	Dunham's Plat and Profile-book.....	\$1.00	\$0.08
2724B	Dunham's Plat and Profile-book, 90 pages.....	2.00	.20

ENGINEERS' BLANK FIELD-BOOKS

LEATHER BINDING AND ROUNDED CORNERS

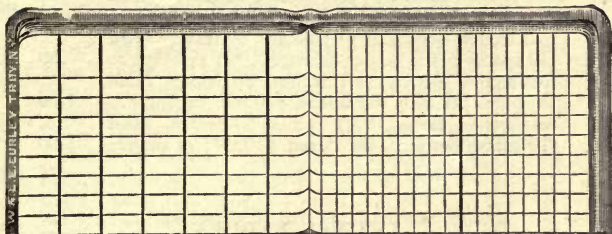

No.		PRICE	POST.
2725	Level-books, $6\frac{3}{4} \times 4\frac{1}{4}$ inches, 60 leaves, per dozen, \$5.00; or single.....	\$0.50	\$0.05

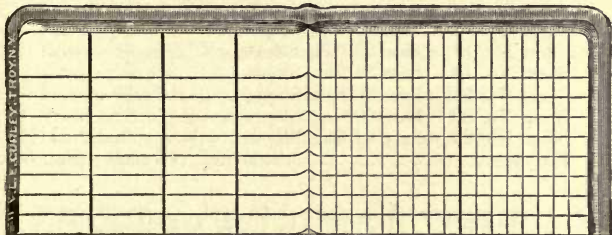

2728	Transit-books, $6\frac{3}{4} \times 4\frac{1}{4}$ inches, 60 leaves, per dozen, \$5.00; or single.....	.50	.05
------	---	-----	-----

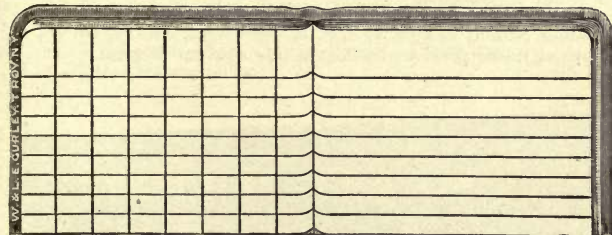

2731	Record-books, $6\frac{3}{4} \times 4\frac{1}{4}$ inches, 60 leaves, per dozen, \$5.00; or single.....	.50	.05
------	--	-----	-----

BLANK FIELD-BOOKS

No.		PRICE	POST.
2736	Cross-section Books, $6\frac{3}{4} \times 4\frac{1}{4}$ inches, 60 leaves, ruled 5 spaces per inch, per dozen, \$5.00 ; or single. . .	\$0.50	\$0.05
2738	Cross-section Books, $6\frac{3}{4} \times 4\frac{1}{4}$ inches, 60 leaves, ruled 10 spaces per inch, per dozen, \$5.00 ; or single. . .	.50	.05
2740	Cross-section Books, 8 x 7 inches, 80 leaves, ruled 5 spaces per inch, per dozen, \$10.00 ; or single. . .	1.00	.15
2742	Cross-section Books, 8 x 7 inches, 80 leaves, ruled 10 spaces per inch, per dozen, \$10.00 ; or single. . .	1.00	.15

LYONS' TABLES

2746 Lyons' Tables. A set of tables for finding at a glance the true cubical contents of Excavation and Embankment for the following Bases, and Ground and Side Slopes. By E. M. Lyons, C. E.

Sheet No. 5.	Base 15 feet, Slopes	$\frac{1}{4}$ to 1
Sheet No. 17.	Base 25 feet, Slopes	$1\frac{1}{2}$ to 1
Sheet No. 19.	Base 28 feet, Slopes	$\frac{1}{2}$ to 1
Sheet No. 21.	Base 30 feet, Slopes	$1\frac{1}{4}$ to 1
Sheet No. 22.	Base 30 feet, Slopes	$1\frac{1}{2}$ to 1
Sheet No. 23.	Base 32 feet, Slopes	1 to 1
Per sheet	15 cents ; post. 5 cents.	

The tables are printed in clear, bold type, on tinted paper, sheets 25 x 16 inches. They may be used by candle-light without injuring the eyesight. Each sheet is complete in itself, and embraces all that is wanted in connection with Base or Slope designated, whether on level or side-hill cross-section.

Tables Nos. 1, 2, 3, 4, 6, 7, 8, 9, 10, 11, 12, 13, 14, 15, 16, 18 and 24, quoted in our previous catalogues, are now out of print.

LEAD-PENCILS. Black Leads

No.		PRICE	POST.
2750	Faber's Hexagon, Siberian, best Drawing, Nos. 2 B to 8 H, per dozen.....	\$1.25	\$0.12
2752	Faber's Hexagon; Drawing, Nos. 1 to 5, per dozen.....	.75	.04
2754	Faber's Round, Drawing, Nos. 1 to 4, per dozen...	.60	.04
2756	Faber's Round, No. 4, small, for Drawing-Compasses, per dozen.....	.60	.02
2758	Faber's Round, Nos. 2 and 3, with rubber tip, for offices, per dozen.....	.50	.04
2765	Faber's Artists' Pencil, with movable lead, H to 6 H, each.....	.25	.02
2768	Faber's Siberian Leads, H to 6 H, for Artists' Pencil, 6 in box, per box.....	.50	.04
	These leads fit the pencil legs of modern Drawing-Compasses.		
2770	Faber's Siberian Round Pencils, 5 in box, 2 B to H, per box.....	.50	.04
2771	Faber's Siberian Round Pencils, 7 in box, 3 B to 2 H, per box.....	.65	.05
2772	Faber's Siberian Round Pencils, 10 in box, 4 B to 4 H, per box.....	.90	.08
2774	Faber's Siberian Round Pencils, 5 in box, with knife and rubber, per box.....	.75	.05
2778	Hardtmuth's Koh-i-noor Pencils, Hexagon, Superfine, H to 8 H, per dozen.....	1.25	.12

COLORED PENCILS AND CRAYONS

2785	Faber's Round, Red, Blue, Green and Yellow Pencils, per dozen.....	\$0.75	\$0.05
2790	Faber's Round, Wax Crayon Pencils, 6 in box, assorted colors, per box.....	.75	.05
2791	Faber's Round, Wax Crayon Pencils, 12 in box, assorted colors, per box.....	1.40	.15



2795

See page 396.

No.		PRICE	Post.
2795	Venetian Crayons, dark red, for marking stakes, per dozen.....	\$0.60	\$0.15
2796	Venetian Crayons, dark blue, for marking stakes, per dozen.....	.60	.15
2797	Hexagon Lumber Crayons, red, blue, or black, per dozen.....	.75	.15

These crayons are superior quality and do not soil the hands.

STEEL LETTERING AND WRITING-PENS

2800	Gillott's Mapping-pens, per dozen.....	\$0.60	\$0.02
2801	Gillott's Lithographic Pens, per dozen.....	.60	.02
2802	Gillott's Crow-Quill Pens, per dozen.....	.60	.02
2806	Gillott's Writing-pens, No. 170, per dozen, 10 cents; per gross.....	1.05	.10
2807	Gillott's Writing-pens, No. 303, per dozen, 15 cents; per gross.....	1.40	.10
2810	Falcon Writing-pens, No. 048, per dozen, 10 cents; per gross.....	.75	.04
2812	Spencerian Writing-pens, per dozen, 15 cents; per gross.....	1.25	.10
2814	Commercial Writing-pens, per dozen, 10 cents; per gross.....	.75	.04
2816	Penholders, black handle, nickel tip, for office use, per dozen.....	.50	.05

ROUND-WRITING PENS, FOR ORNAMENTAL LETTERING



2820



2824

2820	Pens, single pointed, Nos. 1 to 6, assorted, per dozen.....	\$0.12	\$0.02
2822	Pens, single pointed, Nos. 1 to 6, assorted, per gross.....	1.00	.15
2824	Pens, double pointed, Nos. 10, 20, and 30, assorted, per dozen.....	.35	.03
2826	Sample assortment of 25 Pens, per box.....	.35	.04
2828	Penholders for round-writing pens, each.....	.10	.02
2830	Text-book to round-writing, with full instructions..	.65	.05
2831	Copy-book for round-writing practice.....	.35	.05

STEEL ERASING-KNIVES AND
PENCIL SHARPENERS

No.		PRICE	Post.
2835	Steel Blade Eraser, Cocoa handle.....	\$0.35	\$0.03
2836	Steel Blade Eraser, Ivory handle.....	.50	.03
2838	Steel Eraser, long knife blade, Cocoa handle.....	.50	.03
2839A	Metal Erasing-Shield, nickel-plated, $3\frac{3}{4} \times 2\frac{3}{8}$ inches	.25	.02
2839B	Zylonite Erasing-Shield, $4\frac{1}{2} \times 2\frac{1}{2}$ inches.....	.25	.02

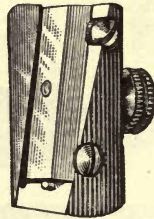
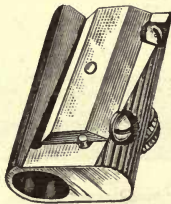

2840

2840	Faber's New Pencil Sharpener (superior).....	.25	.03
2842	Common Pencil Sharpener.....	.10	.02
2843	Fine Steel Pencil-file, with sheath.....	.25	.03
2844	Fine Steel Pencil-file, with Tack-lifter at end.....	.25	.03

ERASING RUBBER



2850

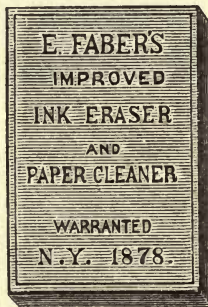

2862



2866

2850	Faber's Artists' Rubber, $1\frac{3}{8} \times 1$ inch, each.....	\$0.05	\$0.01
2852	Faber's Artists' Rubber, $1\frac{3}{4} \times 1\frac{1}{4}$ inches, each.....	.10	.02
2854	Faber's Artists' Rubber, $2 \times 1\frac{3}{8}$ inches, each.....	.15	.03
2856	Faber's Artists' Rubber, $2\frac{1}{4} \times 1\frac{1}{2}$ inches, each.....	.25	.03

No.		PRICE	Post.
2858	Faber's Kneaded Rubber, small	\$0.05	\$0.01
2859	Faber's Kneaded Rubber, large.....	.10	.02
2861	Faber's Circular Ink-eraser.....	.05	.01
2862	Faber's Ink-eraser, $1\frac{1}{2}$ x 1 inch.....	.05	.01
2864	Faber's Ink-eraser, $2\frac{3}{8}$ x $1\frac{1}{2}$ inches.....	.20	.03
2866	Faber's Combined Ink and Pencil-eraser, $2\frac{1}{4}$ x 1 inch15	.02
2867	Faber's Combined Ink and Pencil-eraser, $2\frac{1}{2}$ x $1\frac{3}{8}$ inches25	.03
2868	Faber's Typewriters' Rubber, $3\frac{1}{4}$ x $\frac{5}{8}$ inch.....	.10	.02



2870

2870	Faber's Pointed Rubber, $2\frac{1}{2}$ x $\frac{5}{16}$ inch.....	.09	.01
2871	Faber's Pointed Rubber, 3 x $\frac{3}{8}$ inch.....	.12	.01



2880

2880	Bevel Rubber, green, oblong, No. 40.....	.06	.01
2882	Bevel Rubber, green, oblong, No. 20.....	.12	.02
2884	Bevel Rubber, green, oblong, No. 12.....	.20	.03
2887	Hardtmuth's Pliable Rubber, grey, flat, No. 30....	.07	.02
2888	Hardtmuth's Pliable Rubber, grey, flat, No. 20....	.10	.03
2889	Hardtmuth's Pliable Rubber, grey, flat, No. 12....	.17	.04

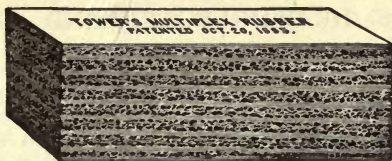

2890

No.		PRICE	POST.
2890	Multiplex Rubber, superior quality, 2 x 1/2 inch	\$0.10	\$0.02
2891	Multiplex Rubber, superior quality, 2 1/2 x 5/8 inch15	.02
2892	Multiplex Rubber, superior quality, 2 3/4 x 3/4 inch25	.03



2896

2895	Sponge Rubber, for cleaning drawings, 2 1/2 x 1 3/4 x 5/8 inch30	.03
2896	Sponge Rubber, for cleaning drawings, 2 x 2 x 1 inch30	.03
2898	Sponge Rubber, for cleaning drawings, 4 x 2 x 1 inch60	.06

RUBBER BANDS

2900	Rubber Bands, No. 8, 7/8 x 1/8 inch, per gross	\$0.15	\$0.02
2902	Rubber Bands, No. 29, 1 1/2 x 1/8 inch, per gross65	.05
2904	Rubber Bands, No. 61, 2 x 1/4 inch, per gross	1.00	.15
2905	Rubber Bands, No. 63, 3 x 1/4 inch, per gross	1.50	.20
2907	Rubber Bands, No. 200, 11 sizes assorted, 1 1/2 to 3 inches, per box	1.00	.18

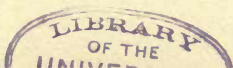

HIGGINS' DRAWING-BOARD AND LIBRARY MUCILAGE

No.		PRICE	POST.
2915	Drawing-board Mucilage, fine quality, 3-ounce jar...	\$0.15	\$0.13
2916	Drawing-board Mucilage, fine quality, 6-ounce jar...	.25	.20
2917	Drawing-board Mucilage, fine quality, 14-ounce jar..	.50	.30
2918	Taurine Mucilage, fine quality, 2-ounce bottle, with brush10	.10
2919	Taurine Mucilage, fine quality, 4-ounce bottle, with brush20	.15
2920	Taurine Mucilage, fine quality, pint bottle, without brush50	.30
2921	Taurine Mucilage, fine quality, quart bottle, without brush80	
2923	Photo-mounter, fine quality, 3-ounce jar15	.13
2924	Photo-mounter, fine quality, 6-ounce jar25	.20



2915



2925

HIGGINS' AMERICAN LIQUID DRAWING-INKS

No.		PRICE
2925	Waterproof Black Ink, small bottle.....	\$0.25
2926	Waterproof Black Ink, 8-oz. bottle.....	2.00
2928	General Black Ink (not waterproof), small bottle.....	.25
2929	General Black Ink (not waterproof), 8-oz. bottle.....	2.00

No.	PRICE	No.	PRICE
2930	Waterproof Carmine .. \$0.25	2935	Waterproof Violet..... \$0.25
2931	Waterproof Scarlet25	2936	Waterproof Green..... .25
2932	Waterproof Vermilion. .25	2937	Waterproof Yellow.... .25
2933	Waterproof Blue..... .25	2938	Waterproof Brown.... .25
2934	Waterproof Indigo.... .25	2939	Waterproof Orange.... .25
2942	Waterproof Ink, any of the above colors, per large (8-oz.) bottle.....		2.00

Postage on the above inks, 7 cents each small bottle, and 30 cents each 8-oz. bottle.

WINSOR & NEWTON'S WATER-COLOR LIQUIDS

IN GLASS BOTTLES

No.	PRICE	No.	PRICE
2945	Indian Ink, Black.... \$0.30	2950	Silver Ink..... \$0.30
2946	Chinese White..... .30	2951	Gold Ink..... .30
2947	Carmine30	2952	Indelible Brown30
2948	Sepia..... .30	2953	Prout's Brown..... .30
2949	Prussian Blue..... .30	2954	Extract of Ox Gall.... .30

Postage on the above inks, 7 cents each bottle.

MISCELLANEOUS LIQUID DRAWING-INKS

No.	PRICE	POST.
2955	Devoe's White Ink, per bottle.....	\$0.25 \$0.08
2956	Bourgeois Black India Ink, per bottle.....	.25 .06
2957	Photo-drawing Ink, Dead Black, per bottle.....	.20 .06
2958	Box of Indelible Drawing-inks, six bottles (Blue, Brown, Carmine, Green, Scarlet, Yellow), per box	1.50 .35
2959	Winsor & Newton's Waterproof Drawing-inks (Black, Brown, Carmine, Emerald Green, In- digo, Vermilion, Yellow), per bottle.....	.25 .06

CHINESE INDIA INK FOR GENERAL DRAWING



2968

No.		PRICE	Post.
2960	Oval, Black, Lion Head, $3\frac{1}{2}$ inches, per cake.....	\$0.35	\$0.02
2962	Round, Black, Lion Head, $2\frac{1}{2}$ inches, per cake....	.25	.02
2963	Round, Black, Lion Head, $4\frac{1}{4}$ inches, per cake....	.65	.04
2965	Hexagon, Black, Lion Head, $3 \times \frac{5}{8}$ inch, per cake..	.50	.03
2967	Square, Black, Super Super, $3 \times \frac{1}{2}$ inch, per cake...	.50	.03
2968	Square, Black, Super Super, $3\frac{3}{4} \times \frac{5}{8}$ inch, per cake..	1.00	.12
2970	Oblong, Black, Double Dragon, fine, $3\frac{5}{8} \times \frac{7}{8}$ inch, per cake.....	2.00	.12
2971	Oblong, Dead Black, for Photo-drawing, $3\frac{1}{2} \times \frac{7}{8}$ inch, per cake.....	1.00	.12
2972	Oblong, Red Ink, fine, $2\frac{3}{4}$ inches, per cake.....	.75	.03
2973	Oblong, Blue Ink, fine, $2\frac{3}{4}$ inches, per cake.....	.75	.03
2974	Oblong, Yellow Ink, fine, $2\frac{3}{4}$ inches, per cake....	.75	.03

JAPANESE INDIA INK

For drawings in which the ink-lines are washed in applying colors



2980

No.		PRICE	Post.
2980	Oblong, black, fine quality, $3\frac{3}{4}$ inches, small cake..	\$1.00	\$0.12
2982	Oblong, black, fine quality, $3\frac{3}{4}$ inches, medium cake	2.00	.13
2984	Oblong, black, fine quality, $3\frac{3}{4}$ inches, large cake..	3.00	.14

WINSOR & NEWTON'S WATER-COLORS

MOIST IN CHINA PANS, OR HARD COLORS IN CAKES

The moist colors are usually preferred, as they do not waste by crumbling



WHOLE CAKE



HALF CAKE



WHOLE PAN



HALF PAN

No. 2990 Whole, each, 25 cts.; Half, each, 15 cts.

1 Antwerp Blue	*14 Dragon's Blood	30 Olive Green
2 Bistre	15 Emerald Green	31 Orange Chrome
3 Blue Black	*16 Flake White	32 Payne's Gray
* 4 British Ink	17 Gamboge	33 Prussian Blue
* 5 Bronze	18 Hooker's Green No. 1	34 Prussian Green
6 Brown Ochre	19 Hooker's Green No. 2	35 Raw Sienna
7 Brown Pink	20 Indian Red	36 Raw Umber
8 Burnt Sienna	21 Indigo	37 Roman Ochre
9 Burnt Umber	22 Italian Pink	38 Sap Green
94 Charcoal Gray	23 Ivory Black	39 Terre Verte
10 Chinese White	*24 King's Yellow	40 Vandyke Brown
95 Chrome Lemon	25 Lamp Black	41 Venetian Red
11 Chrome Yellow	26 Light Red	42 Vermilion
12 Cologne Earth	27 Naples Yellow	43 Yellow Lake
*48 Constant White	28 Neutral Tint	44 Yellow Ochre
13 Deep Chrome	29 New Blue	

2992 Whole, each, 45 cts.; Half, each, 25 cts.

*45 Black Lead	50 Mars Yellow	54 Reuben's Madder
46 Brown Madder	51 Neutral Orange	55 Scarlet Lake
47 Cerulean Blue	62 Orange Vermilion	56 Scarlet Vermilion
49 Crimson Lake	52 Purple Lake	57 Sepia
60 Indian Yellow	53 Roman Sepia	58 Warm Sepia

No.

2994 Whole, each, 65 cts.; Half, each, 35 cts.

67 Cadmium Orange	72 French Blue	74 Green Oxide of Chromium
68 Cadmium Yellow, Pale	75 Indian Purple	98 Permanent Mauve
69 Cadmium Yellow	76 Intense Blue	99 Permanent Violet
59 Cobalt Blue	61 Lemon Yellow	79 Pure Scarlet
97 Cobalt Green	77 Mars Orange	63 Violet Carmine

2996 Whole, each, 90 cts.; Half, each 45 cts.

65 Aureolin	71 Field's Orange Vermilion	82 Purple Madder
91 Aurora Yellow	81 Madder Carmine	80 Rose Madder
66 Burnt Carmine	78 Pink Madder	90 Scarlet Madder
70 Carmine	92 Primrose Aureolin	93 Yellow Carmine

2998 Whole, each \$1.40; Half, each, 70 cts.

83 Smalt	84 Ultramarine Ash
----------	--------------------

Colors marked * are not made in pans.

Postage on water colors, 1 cent each.

The following colors are generally used by Architects and Civil and Mechanical Engineers:

Burnt Umber to represent earth.
 Burnt Sienna to represent wood.
 Light Red to represent brick.
 Sepia and Yellow Ochre to represent stone.
 Prussian Blue to represent wrought iron.
 Payne's Gray to represent cast iron.
 Gamboge to represent brass.
 Gamboge and Carmine to represent copper.
 Prussian Blue and Carmine to represent steel.

In Topography the following colors are generally used:

Hooker's Green No. 2 to represent grass.
 Burnt Sienna to represent cultivated ground.
 Burnt Sienna and Hooker's Green to represent uncultivated ground.
 Indigo and Hooker's Green to represent swamp.
 Gamboge and Hooker's Green to represent trees.
 Yellow Ochre to represent roads and streets.
 Indigo to represent water.
 Carmine to represent buildings, bridges and masonry.
 Sepia to represent hills.
 Sepia to represent shade lines and shadows.

"COMPLETE"

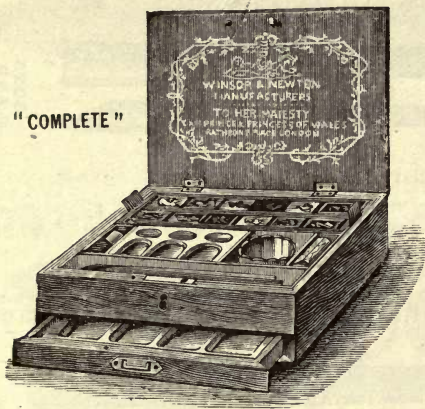

3000

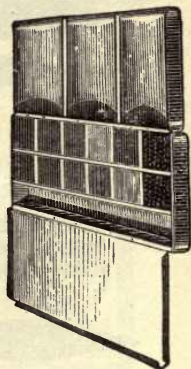

3010

WINSOR & NEWTON'S WATER-COLORS

IN POLISHED MAHOGANY BOX, WITH LOCK AND KEY, AND DRAWER, PAINT-STONE, WATER-GLASS, INDIA INK, BRUSHES AND COLORS

No.		PRICE	Post.
3000	Complete Box, with 12 colors, whole cakes	\$ 9.00	\$1.00
3002	Complete Box, with 18 colors, whole cakes	13.50	1.15
3004	Complete Box, with 12 colors, half cakes	6.00	.50
3006	Complete Box, with 18 colors, half cakes	7.75	.65

EMPTY JAPANED TIN COLOR-BOXES

3010	Japanned Box, to hold 6 whole or 12 half pans . . .	\$0.80	\$0.06
3011	Japanned Box, to hold 10 whole or 20 half pans . . .	1.00	.15
3012	Japanned Box, to hold 12 whole or 24 half pans . . .	1.15	.20
3014	Japanned Box, to hold 18 whole or 36 half pans . . .	1.40	.26

EMPTY WOOD SLIDE-LID COLOR-BOXES.

3015	Color-box to hold 6 whole or half cakes	\$0.40	\$0.04
3016	Color-box to hold 12 whole or half cakes50	.08
3017	Color-box to hold 18 whole or half cakes60	.12

WATER-COLOR BRUSHES

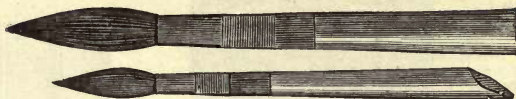

6
3020
AND
3025

No.
3020 Camel Hair in Quills:

	No. 1	2	3	4	5	6	7	8	Post.
Each,	\$0.05	.05	.06	.06	.08	.08	.10	.10	\$0.01

3025 Red Sable in Quills:

	No. 1	2	3	4	5	6	7	8	Post.
Each,	\$0.10	.12	.15	.20	.25	.33	.45	.60	\$0.01



6
3030

3030 Camel Hair in Tin, with handle:

	No. 1	2	3	4	5	6	Post.
Each,	\$0.10	.10	.12	.12	.15	.15	\$0.02



4
3035

3035 Red Sable, in Albata, with handle:

	No. 1	2	3	4	5	6	7	13	14	Post.
Each,	\$0.20	.25	.35	.45	.55	.65	.75	1.00	1.30	\$0.02 to \$0.10



3040

3040 Camel Hair Sky or Wash Brush, in Tin, with handle:

	No. 0	1	2	3	4	Post.
Each,	\$0.18	.20	.25	.35	.45	\$0.02



3045

No. 3045 Camel Hair Wash Brushes in Tin, with two points :

	No. 0	1	2	3	Post.
Each,	\$0.35	.40	.50	.65	\$0.02

WATER-GLASSES, INK AND COLOR-SLABS

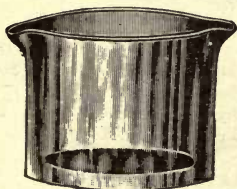

3050

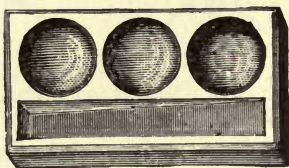

3054

		PRICE	POST.
3050	Artists' Water-glass, $2\frac{3}{8}$ inches	\$0.12	\$0.08
3051	Artists' Water-glass, $2\frac{1}{4}$ inches20	.10
3052	Artists' Water-glass, $3\frac{1}{4}$ inches25	10
3054	Ink or Color-slab, $2\frac{3}{4}$ x $1\frac{1}{2}$ inches10	.05
3055	Ink or Color-slab, $3\frac{1}{2}$ x $2\frac{1}{4}$ inches15	.07
3056	Ink or Color-slab, 4 x $2\frac{1}{2}$ inches25	.10
3057	Ink or Color-slab, $4\frac{3}{8}$ x $2\frac{3}{4}$ inches30	.15
3065	Slate Ink-slab, $3\frac{1}{2}$ x $3\frac{1}{2}$ inches, with glass cover35	.15
3067	Opal Glass Ink-saucer, with cover, $3\frac{1}{4}$ inches50	.15

PATENT INK-SLAB

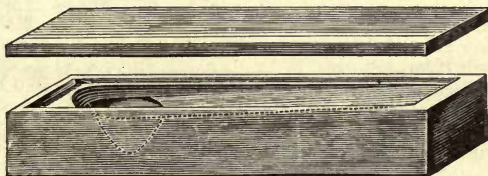

3070

3070	Patent Ink-slab, China, with cover, $4\frac{1}{2}$ x $1\frac{3}{8}$ inches ..	\$0.35	\$0.12
3071	Patent Ink-slab, China, with cover, $5\frac{1}{4}$ x $2\frac{1}{8}$ inches ..	.40	.16

COLOR-SAUCERS

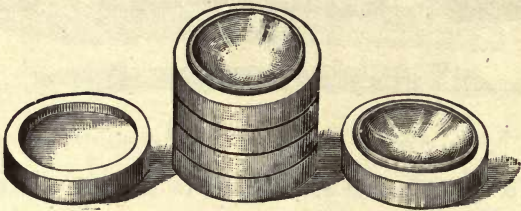

3075

No.		PRICE	POST.
3075	Nest of 5 Saucers and a cover, $2\frac{3}{8}$ inches, per nest..	\$0.45	\$0.15
3076	Nest of 5 Saucers and a cover, $2\frac{5}{8}$ inches, per nest..	.55	.20
3077	Nest of 5 Saucers and a cover, $3\frac{1}{4}$ inches, per nest..	.65	.28
3078	Nest of 5 Saucers and a cover, $3\frac{3}{4}$ inches, per nest..	.75	.35

BRASS STENCILS. ALPHABETS AND FIGURES

	Height of Letters.....	$\frac{1}{4}$ in.	$\frac{3}{8}$ in.	$\frac{1}{2}$ in.	$\frac{5}{8}$ in.	$\frac{3}{4}$ in.	1 in.
3100	Stencil Alphabet....	\$1.00	\$1.15	\$1.30	\$1.50	\$1.75	\$2.00
3101	Stencil Alphabet....	1.85	2.00	2.15	2.30	2.50	2.75
3102	Stencil Alphabet....	4.00	4.15	4.30	4.50	4.75	5.00
3103	Stencil Alphabet....	1.85	2.00	2.15	2.30	2.50	2.75

A set of Figures to match any of these Alphabets will cost one-third the price of the same style and size of Alphabet.

Postage on each Alphabet.....	\$0.14
Postage on each set of Figures, Nos. 3100, 3101, and 3103,	.04
Postage on each set of Figures, No. 3102.....	.12

BRASS STENCIL PLATES

	PRICE	POST.
3110 North Point, full size.....	\$0.50	\$0.02
3111 North Point, full size.....	.75	.02
3112 North Point, full size.....	.60	.02
3115 Ornamental Corner, full size.....	1.00	.10
3116 Ornamental Corner, full size.....	.75	.03
3120 Dasher, full size.....	.25	.02
3121 Dasher, full size.....	.25	.02

A Stencil Brush is furnished without extra charge.

Use thick India ink for marking.

Other styles and sizes of Alphabets, Figures, and Stencil Plates made to order.

STENCIL PLATES

EMMA A 43

3100

3101

3102

3103

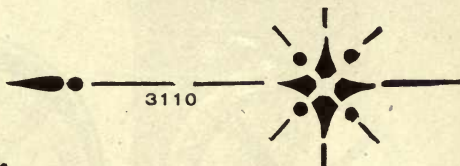

3110

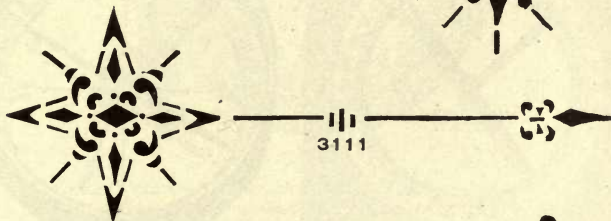

3111

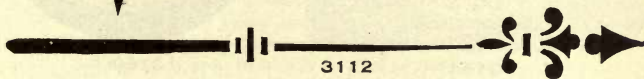

3112



3115

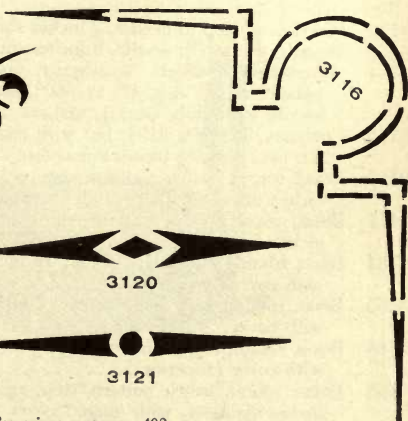

3116



3120



3121

For prices, see page 408.

COMMON POCKET COMPASSES



3154

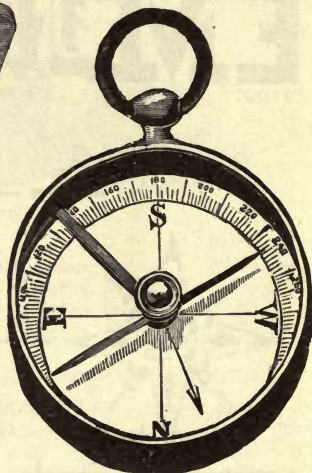

3160

No.		PRICE	Post.
3150	Wood case, stop to needle, 2 inches square, French.	\$2.00	\$0.12
3152	Wood case, stop to needle, 3 inches square, French.	2.50	.15
3154	Government pattern, mahogany case, 3 inches square, raised ring, 0° to 360°, superior 2-inch needle with stop, Gurley, maker.....	4.00	.15
3155	Compass, like No. 3154, but with raised ring 0° to 90° each way, 3¼ inches square and 2½-inch needle	5.00	.20
3160	Brass, round, watch pattern, stop, agate center, 1½ inches diameter.....	.85	.04
3161	Brass, round, watch pattern, stop, agate center, 2 inches diameter.....	1.00	.12
3164	Brass, round, stop, agate center, 1½ inches diameter, with cover.....	1.10	.12
3165	Brass, round, stop, agate center, 2 inches diameter, with cover.....	1.25	.12
3166	Brass, round, stop, agate center, 2½ inches diameter, with cover (superior).....	2.50	.14
3168	Brass, round, watch pattern, stop, agate center, 1½ inches diameter, with hinged cover.....	1.25	.12

No.		PRICE	POST.
3170	Brass, round, watch pattern, stop, agate center, 2 inches diameter, with hinged cover.....	\$1.50	\$0.12

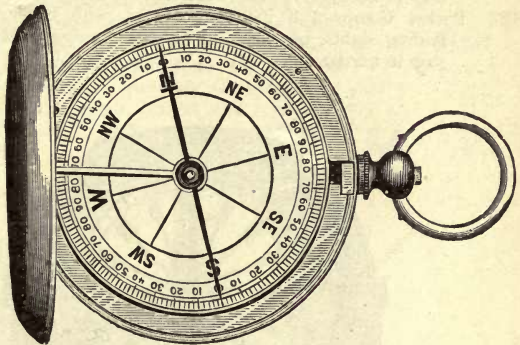

3175

3175	Pocket Compass, $1\frac{3}{4}$ inches diameter, hunting-case, spring catch, stop to needle in joint of cover, and bar needle with agate center.....	3.50	.12
3176	Pocket Compass, $2\frac{1}{4}$ inches diameter, hunting-case, spring catch, stop to needle in joint of cover, and bar needle with agate center.....	4.50	.12

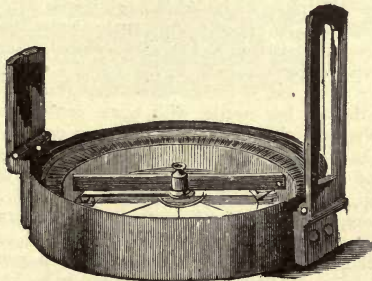

3182

No.		PRICE	POST.
3182	Pocket Compass, 2½ inches diameter, with cover, folding sights, bar needle with agate center, and stop to needle.....	\$5.50	\$0.14
3183	Pocket Compass, 3 inches diameter, with cover, folding sights, bar needle with agate center, and stop to needle.....	6.50	.16

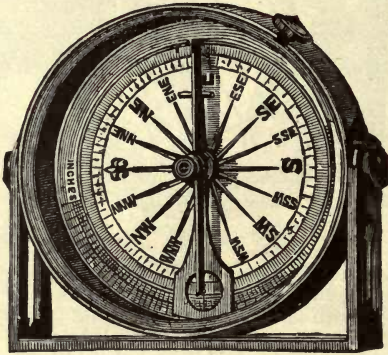

3186 As Clinometer

3186	Clinometer Compass, 2½ inches diameter, graduated to one degree, bar needle with agate center and stop, pivoted sights to swing over compass face, cover, and morocco case.....	7.25	.15
3187	Clinometer Compass, 3 inches diameter, graduated to one degree, bar needle with agate center and stop, pivoted sights, cover, and morocco case....	8.75	.18
3188	Pocket Compass, 3¾ inches diameter, heavy brass case and cover, 2½-inch needle with agate center and stop, superior, Gurley, maker.....	6.00	.20
3192	Pocket Compass, 1¾ inches diameter, watch pattern, stem stop, Singer's patent pearl dial.....	3.85	.12
3194	Geological Compass, 2¾ inches diameter, with pendulum, for ascertaining the angle of dip in rocks..	4.25	.15
3200	Pocket Compass, watch pattern, 2½ inches diameter, hunting-case, raised ring, agate center, stop to needle, folding sights.....	5.00	.15

No.		PRICE	POST.
3215	Brunton Pocket Transit. Designed for civil and mining engineers, mine managers and geologists. Can be used as a prismatic compass, sighting compass, clinometer and Abney Level. Aluminum case. Size $2\frac{3}{4} \times 2\frac{3}{4} \times 1$ inch. Weight 8 ounces...	\$25.00	\$0.25
3220	Pocket Alt-Azimuth, with Telescope, for travelers and military surveyors. Altitudes, azimuths, compass bearings, clinometer degrees and levels are all obtained by this instrument. Size $6\frac{1}{2} \times 2\frac{1}{2} \times 1\frac{1}{8}$ inches, in case.....	50.00	.40

PRISMATIC COMPASSES

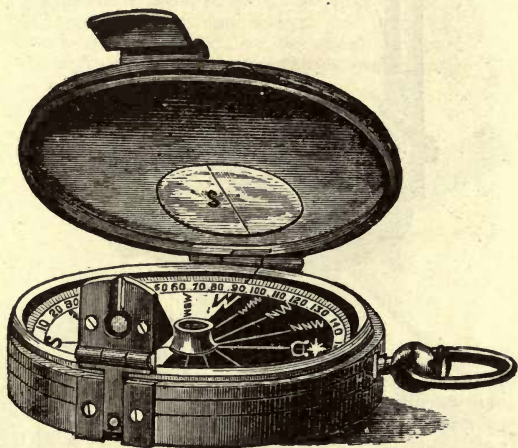

3225

3225	Prismatic Compass, $2\frac{1}{8}$ inches diameter, hunting-case ; can be used as an ordinary compass without opening the cover, and a prismatic compass by raising the cover, glazed with a stout glass, on which is etched a line for the sight. With folding prism and floating card dial with stop.....	\$15.00	\$0.15
3226	Prismatic Compass, $3\frac{3}{8}$ inches diameter, with floating metal dial, azimuth glasses, folding prism, folding sight with hinged mirror, ball-joint and staff socket, in morocco case.....	21.50	.25

PRISMATIC COMPASSES

No.		PRICE	POST.
3227	Prismatic Compass, 3 inches diameter, with floating card dial graduated to $\frac{1}{2}$ degrees, folding prism and folding sight (nearly enclosed top), in leather sling case.....	\$16.00	\$0.20

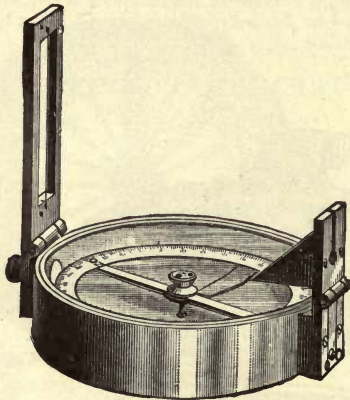

3228

3228	Prismatic Compass, 3 inches diameter, with floating metal dial divided to $\frac{1}{2}$ degrees, agate center with stop, folding prism, and folding sight (nearly enclosed top not shown in cut), in leather sling case	20.00	.20
3230	Prismatic Compass, Barker's Patent, $2\frac{3}{4}$ -inch floating dial, agate center with stop, mounted beneath $2\frac{3}{4}$ -inch pendulum dial, graduated for altitudes 0° to 180° , also graduated 0° to 90° both ways as clinometer and with scale of rise or fall in inches per yard; folding prism and hair sight, metal case, and in leather sling case.....	27.00	.25
3232	Prismatic Compass, 3 inches diameter, with metal dial graduated to $\frac{1}{2}$ degrees, agate center with stop, folding prism, azimuth glasses, folding sight with hinged and sliding mirror, metal cover, in leather sling case.....	30.00	

SEXTANTS

No.		PRICE
3240	Pocket Sextant, graduated to $\frac{1}{2}$ degrees, with vernier to 1 minute, telescope, two neutral glasses, magnifier, tangent screw, etc. In metal box 3 inches diameter, and in leather sling case.....	\$42.50
3245	Sextant of gun-metal, $4\frac{1}{2}$ inches radius, arc of 150° graduated on silver to 15 minutes with vernier to 15 seconds, clamp and tangent and magnifier, one terrestrial telescope, one celestial telescope, one sight-tube, six neutral glasses, two mirrors, in mahogany box	50.00
3247	Sextant of gun-metal, $6\frac{1}{2}$ inches radius, arc of 150° graduated on silver to 10 minutes with vernier to 10 seconds, clamp and tangent and magnifier, two celestial telescopes, one terrestrial telescope, one sight-tube, seven neutral glasses, two mirrors, in mahogany box.....	80.00

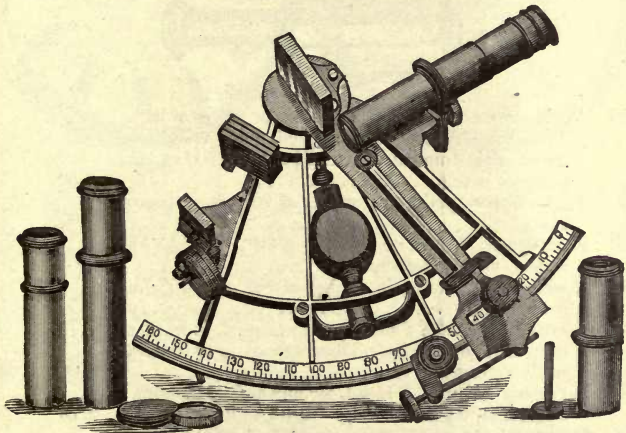

3248

3248	Sextant of gun-metal, superior, 7 inches radius, arc of 150° graduated on silver to 10 minutes with vernier to 10 seconds, clamp and tangent and magnifier, two celestial telescopes, one terrestrial telescope, one sight-tube, seven neutral glasses, two mirrors, in mahogany box	100.00
------	---	--------

ARTIFICIAL HORIZONS, ANGLE-MIRRORS AND PRISMS. SURVEYORS' CROSS-STAFF HEADS

No.		PRICE	POST.
3250	Artificial Horizon, with black glass plane mounted in brass frame, with three leveling-screws, and sensitive level-vial. All in mahogany box.	\$16.00	\$0.30
3252	Mercurial Horizon, iron trough, iron bottle with screw stopper and funnel cap, glazed metal roof. All in mahogany box	30.00	

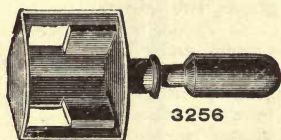

3256

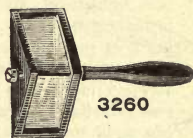

3260

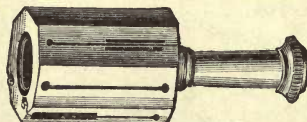

3265

3255	Angle-mirror, with small plummet, for angles of 90°. The handle can be detached and stored in frame of instrument. Size, $2\frac{1}{2} \times 2 \times 1\frac{3}{4}$ inches, in morocco case.	7.50	.15
3256	Angle-mirror, plain, for angles of 90°, in morocco case	5.00	.15
3260	Rectangular Prism, for angles of 90°, $2\frac{1}{2} \times 1\frac{1}{4} \times 1\frac{5}{8}$ inches, in morocco case.	5.00	.12
3262	Double Prism, to take angles of 90° and 45°, in morocco case.	10.00	.12
3264	Penta-prism Range Finder, brass mounted, in leather case, with directions. Distances up to two miles easily determined	10.00	.25
3265	Surveyors' Cross-staff Head, for 45° and 90° angles. Octagonal, $2\frac{1}{2}$ inches long. With staff socket.	2.75	.30
3266	Surveyors' Cross-staff Head, for 45° and 90° angles. Octagonal, 3 inches long. With magnetic compass, $1\frac{3}{4}$ -inch needle, and with staff socket	4.75	.35
3267	Surveyors' Cross-staff Head, for 45° and 90° angles. Round, $3\frac{3}{4}$ inches long. With vertical axis graduated to 1° and vernier to 3 minutes. With magnetic compass, $2\frac{1}{8}$ -inch needle, and with staff socket.	11.50	.40

PEDOMETERS, PASSOMETERS, TALLY REGISTER AND ODOMETER

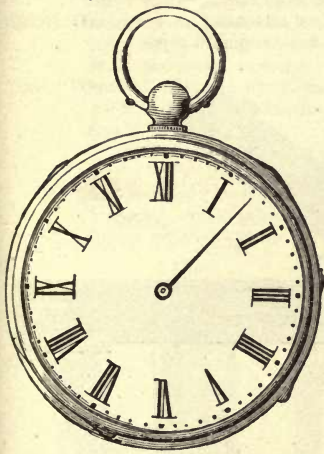

3270

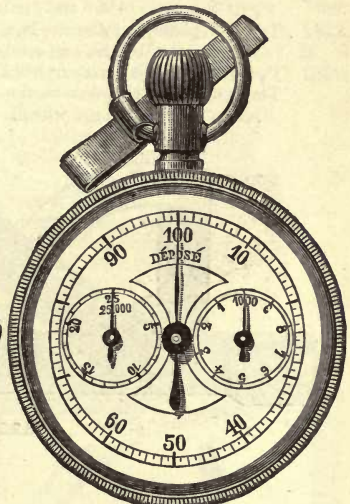

3276

No.		PRICE	POST.
3270	Pedometer, watch form. One dial registers distance walked up to 12 miles by each $\frac{1}{4}$ mile	\$4.50	\$0.12
3272	Pedometer, watch form. Two dials register distance walked up to 50 miles by each 80 yards.	5.25	.12
3276	Passometer, watch form. Three dials register each step up to 25,000 steps, and with stem attachment to set the pointers to zero at will	6.00	.12
3277	Passometer, like No. 3276, but with four dials, registering each step up to 100,000 steps.	6.50	.12

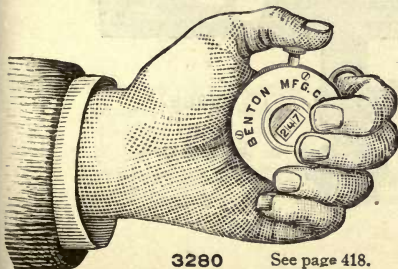

3280

See page 418.



3282

NEEDER MFG. CO.
HARTFORD, CONN.

No.		PRICE	POST.
3280	Tally Register, for surveyors and others; useful in chaining, for counting persons, cattle, coal, wheat, etc. Registers to 999 and can be set to zero at will..	\$2.50	\$0.15
3281	Tally Register, similar to No. 3280, with 4 dials. Registers to 10,000, and can be set to zero at will..	5.50	.20
3282	Veeder Odometer, with fixtures for attaching. This Odometer registers on the dial every fifth revolution of the carriage wheel.	3.50	.20

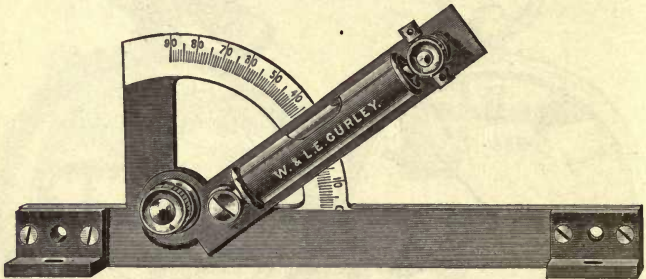

3284

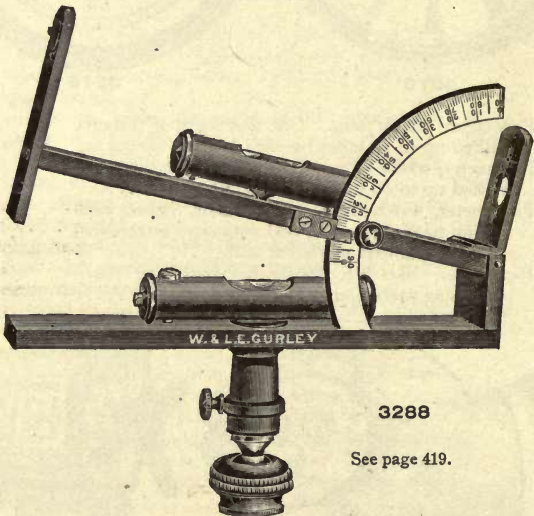

3288

See page 419.

CLINOMETERS

SEE CUTS, PAGE 418

No.		PRICE	POST.
3284	Clinometer or Slope-level, Gurley, maker, 7 inches long, arc to whole degrees, in wood case.....	\$8.00	\$0.30
3288	Clinometer or Slope-level, Gurley, maker, 6 inches long, arc to whole degrees, two levels, sights and staff mountings, in wood case.....	16.00	.50
3290	Boxwood Clinometer, 12-inch, folding to 6-inch, with two levels, compass, inclination scale, and sights, in leather case.....	12.00	.20

The inclination scale gives the value of any angle. The angle, ascertained from the graduated arc, refers to that degree in the column marked "angle," and another column gives the rise or fall in any given distance.

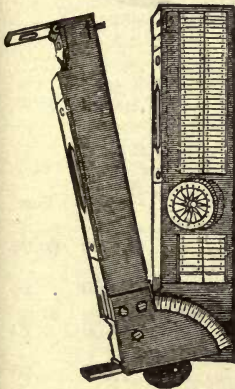

3290

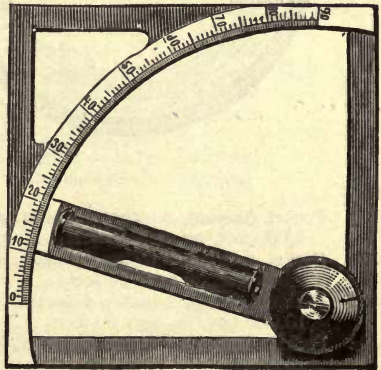

3292

3292	Clinometer or Slope-level, brass frame, 4 inches square, arc to whole degrees and vernier to 5 minutes. The design renders the measurement of the inclination of the under side of a plane available, as any of the four edges may be used ; in case.....	10.00	.40
------	---	-------	-----

ANEROID BAROMETERS

FOR ASCERTAINING HEIGHTS, DIFFERENCES OF LEVEL AND METEOROLOGICAL CHANGES, APPROACH OF STORMS, ETC.

Mountain Aneroid Barometers, compensated for temperature, with brass cases and silvered dials, in morocco cases.

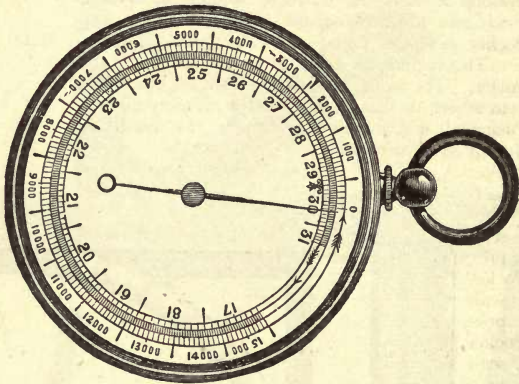

3303

No.		PRICE	POST.
3300	Pocket Aneroid, 2 inches diameter, altitude scale to 3,000 feet, by each 10 feet.....	\$18.00	\$0.20
3301	Pocket Aneroid, 2 inches diameter, altitude scale to 5,000 feet, by each 20 feet.....	17.00	.20
3302	Pocket Aneroid, 2 inches diameter, altitude scale to 10,000 feet, by each 50 feet.....	18.00	.20
3303	Pocket Aneroid, 2 inches diameter, altitude scale to 15,000 feet, by each 100 feet.....	19.00	.20
3304	Pocket Aneroid, 2 inches diameter (nickel hunting-case and omitting morocco case), altitude scale to 6,000 feet, by each 50 feet.....	22.00	.20
3306	Pocket Aneroid, $2\frac{3}{4}$ inches diameter, altitude scale to 10,000 feet, by each 50 feet, with thermometer and opposite side with pocket compass.....	27.00	.30
3308	Pocket Aneroid, $2\frac{3}{4}$ inches diameter, altitude scale to 16,000 feet, by each 50 feet, with thermometer and opposite side with pocket compass.....	29.00	.30

No.		PRICE	POST.
3310	Pocket Aneroid, $2\frac{3}{4}$ inches diameter, altitude scale to 3,000 feet, by each 10 feet.....	\$19.00	\$0.25
3312	Pocket Aneroid, $2\frac{3}{4}$ inches diameter, altitude scale to 5,000 feet, by each 20 feet.....	18.00	.25
3313	Pocket Aneroid, $2\frac{3}{4}$ inches diameter, altitude scale to 8,000 feet, by each 20 feet.....	18.00	.25
3314	Pocket Aneroid, $2\frac{3}{4}$ inches diameter, altitude scale to 10,000 feet, by each 50 feet.....	19.00	.25
3315	Pocket Aneroid, $2\frac{3}{4}$ inches diameter, altitude scale to 12,000 feet, by each 50 feet.....	19.00	.25
3316	Pocket Aneroid, $2\frac{3}{4}$ inches diameter, altitude scale to 16,000 feet, by each 50 feet.....	20.00	.25
3318	Pocket Aneroid, $2\frac{3}{4}$ inches diameter, altitude scale to 20,000 feet, by each 100 feet.....	22.00	.25
3322	Pocket Aneroid, $2\frac{3}{4}$ inches diameter, altitude scale to 10,000 feet, by each 50 feet, and thermometer..	22.00	.25
3324	Pocket Aneroid, $2\frac{3}{4}$ inches diameter, altitude scale to 16,000 feet, by each 50 feet, and thermometer..	23.00	.25
3329	Pocket Metric Aneroid, $2\frac{3}{4}$ inches diameter, altitude scale to 1,500 meters, reading to 5 meters, and pressure scale reading to $\frac{1}{2}$ millimeter.....	18.00	.25
3330	Pocket Metric Aneroid, $2\frac{3}{4}$ inches diameter, altitude scale to 3,000 meters, reading to 10 meters, and pressure scale reading to 1 millimeter.....	19.00	.25
3332	Pocket Metric Aneroid, $2\frac{3}{4}$ inches diameter, altitude scale to 5,000 meters, reading to 20 meters, and pressure scale reading to 2 millimeters.....	20.00	.25
3336	Plain Aneroid, no altitude scale, 5 inches diameter, with thermometer and open face to show mechanism, for parlor use.....	15.00	
3338	Plain Aneroid, no altitude scale, $6\frac{1}{2}$ inches diameter, and with two thermometers reading to scales of Fahrenheit, Reaumur, and Celsius, and open face to show mechanism, for parlor use.....	18.00	
3340	Self-recording Aneroid Barometer, with attached thermometer. In mahogany case with glass front..	45.00	

The cylinder makes a complete revolution in seven days, and thus each diagram gives a barometric record for one week.

The graduated spaces on the altitude scales of Barometers No. 3300 to 3332 can be subdivided by the eye or by using a magnifier, and thus a closer reading obtained.

A leather sling case for Barometers Nos. 3306 to 3332, and omitting the morocco case, costs, extra, \$1.50.

SURVEYING AND MINING ANEROIDS

BRONZED CASES, SILVERED DIALS WITH REVOLVING MAGNIFIER. COM- PENSATED FOR TEMPERATURE. IN LEATHER SLING CASES		PRICE	POST.
No.			
3350	Surveying Aneroid, 3 inches diameter, altitude scale to 6,000 feet, by each 20 feet and by vernier to 2 feet.....	\$42.00	\$0.40
3352	Surveying Aneroid, 3 inches diameter, with altitude scale to 10,000 feet, by each 50 feet and by vernier to 5 feet.....	45.00	.40
3354	Surveying Aneroid, 3 inches diameter, with altitude scale to 15,000 feet, by each 50 feet and by vernier to 5 feet.....	48.00	.40
3355	Mining Aneroid, 3 inches diameter, arranged to register 2,000 feet below sea-level to 4,000 feet above, by each 20 feet and by vernier to 2 feet..	42.00	.40
3360	Surveying Aneroid, 5 inches diameter, with altitude scale to 5,000 feet, by each 10 feet and by vernier to 1 foot.....	50.00	
3362	Surveying Aneroid, 5 inches diameter, with altitude scale to 10,000 feet, by each 20 feet and by vernier to 2 feet.....	52.00	
3364	Surveying Aneroid, 5 inches diameter, with altitude scale to 15,000 feet, by each 20 feet and by vernier to 2 feet.....	54.00	
3366	Surveying Aneroid, 5 inches diameter, with altitude scale to 20,000 feet, by each 50 feet and by vernier to 5 feet.....	57.00	

The Surveying and Mining Aneroid has been constructed especially for the use of Surveyors and Engineers, for ascertaining slight variations in gradients, levels, etc., and from its extreme sensitiveness will be found of considerable utility in Mining and Surveying work generally.

The Vernier Scale is moved by rack and pinion, and the magnifier which rotates on the outer circumference of the instrument facilitates the reading of the vernier.

A Treatise on the Aneroid Barometer; its construction and use. Illustrated. 50 cents.

With the exception of Nos. 3336 to 3340, all the Barometers mentioned on pages 420 to 422 are furnished with a rating card, showing the result of tests in comparison with our standard mercurial barometer.

TO USE THE ANEROID, WITH ALTITUDE SCALE

Find the height in feet at first station and subtract this from the height in feet at second station. If the mean temperature is greater or less than 50° F., apply correction for temperature as hereafter given.

Example :

Aneroid at Station A, 1,800 feet. Thermometer, 50°.
 Aneroid at Station B, 800 feet. Thermometer, 70°.

The approximate height is 1,000 feet. The sum of the temperatures is 120. A correction of + 20 is therefore applied. This is 20 feet. The difference of elevation is therefore 1,000 + 20 = 1,020 feet.

TO FIND THE RELATIVE HEIGHT OF TWO GIVEN PLACES

Take a reading of the Aneroid at first station ; subtract from this the reading at second station. The product multiplied by 9 will give the difference of altitude in feet, thus :

First Station, 30.20 ; Second Station, 29.99 ; $30.20 - 29.99 = .21$;
 $.21 \times 900$ (or 21×9) = 189 feet = difference of altitude.

This under ordinary pressures and with a temperature about 50° F. will give good results. If the temperature is over 70° F. multiply by 10. The table prepared by Mr. Symons is more strictly accurate :

MEAN TEMPERATURE	30°	40°	50°	60°	70°	80°
Mean pressures, 27 inches..	9.7	9.9	10.1	10.3	10.5	10.8
Mean pressures, 28 inches..	9.3	9.5	9.8	10.0	10.2	10.4
Mean pressures, 29 inches..	9.0	9.2	9.4	9.6	9.8	10.0
Mean pressures, 30 inches..	8.7	8.9	9.1	9.3	9.5	9.7

Roughly speaking, the barometer falls one inch for every 900 feet of ascent ; or at mean atmospheric pressure in this latitude,

- Above sea-level 917 feet, the barometer falls.....1 inch.
- Above sea-level 1,860 feet, the barometer falls.....2 inches.
- Above sea-level 2,830 feet, the barometer falls.....3 inches.
- Above sea-level 3,830 feet, the barometer falls.....4 inches.
- Above sea-level 4,861 feet, the barometer falls.....5 inches.

ANEMOMETERS

FOR MEASURING THE PRESSURE AND VELOCITY OF CURRENTS OF AIR IN COAL MINES, AND VENTILATORS, FLUES, ETC., OF PUBLIC BUILDINGS

“Biram’s.”—For registering the velocity of currents of air in mines, tunnels, etc., by means of a light fan, the revolutions of which are recorded on a dial in the center of the instrument.

This instrument placed in the passage of a mine registers automatically the rate at which the air is traveling through it, and a simple observation will detect any slackening of the current arising from obstruction of the ways, or want of attention at the ventilating furnace, or fan-wheel.

We furnish a rating card with each Anemometer, showing the friction constant to be added in every computation, which is ascertained by us by actual experiment.

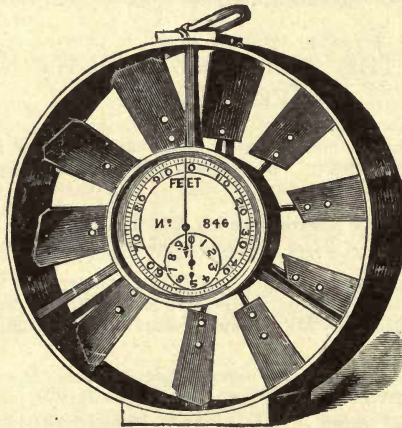

3380

No.		PRICE	Post.
3380	Biram’s Anemometer, 3 inches diameter, reading to 1,000 feet, with disconnecter, in morocco case...	\$20.00	\$0.30
3382	Biram’s Anemometer, 4 inches diameter, reading to 1,000 feet, with disconnecter, in wood case.....	19.00	.40
3383	Biram’s Anemometer, 4 inches diameter, reading to 100,000 feet, with disconnecter, in wood case....	21.00	.40
3384	Biram’s Anemometer, 6 inches diameter, reading to 1,000 feet, with disconnecter, in wood case.....	21.00	.60
3386	Biram’s Anemometer, 6 inches diameter, reading to 100,000 feet, with disconnecter, in wood case....	23.00	.60

No.		PRICE	POST.
3388	Biram's Anemometer, 6 inches diameter, reading to 10,000,000 feet, with disconnecter, in wood case..	\$33.00	\$0.60
3390	Biram's Anemometer, watch pattern, hunting-case, very sensitive, reading to 1,000 feet.....	30.00	.18

Pocket Size, 2 inches diameter.—Is made in the form of a watch. The top and bottom of the case, when opened, form a base for the instrument, and a check-spring passing through the pendant acts as a stop to the movement, on being pressed by the finger at the expiration of the time necessary to make the observation. The movement is jeweled at four points. The outer circle of divisions on the dial records by single feet up to one hundred; the smaller dial continues the enumeration up to one thousand feet.

HOW TO USE THE ANEMOMETER

The Anemometer consists of a series of vanes, which revolve with the action of the air-current, the number of revolutions, or numbers proportioned to the revolutions, being registered by a pointer on the face of a dial, forming part of the instrument itself. An observer has only to record the position of the several indices at the first observation, by writing the lower of the two figures on the respective circles, between which the index points, in their proper order, and deduct the amount from their position at the second observation, to ascertain the velocity of the air which has passed in the interval. This, multiplied by the area in feet of the passage where the instrument is placed, will show the number of cubic feet which has passed during the same period.

Thus, suppose the observation of one minute gives :

Second reading	525
First reading	225
	300
Add correction, say.....	30
	330

Size of passage in feet, $10 \times 5 \times 330 = 16,500$ feet per minute.

The correction added above is the value of the constant of friction, which must be found for each machine by actual experiment.

TO FIND THE VELOCITY OF THE AIR IN THE PASSAGE

Proceed thus: Suppose the Anemometer indicates 330 feet per minute. $330 \div 88 = 3.75$, or $3\frac{3}{4}$ miles per hour, 88 being $\frac{1}{80}$ th of a mile.

To ascertain the force of the air-current, multiply the square of the velocity of the air in feet per second by .0023.

AIR METERS

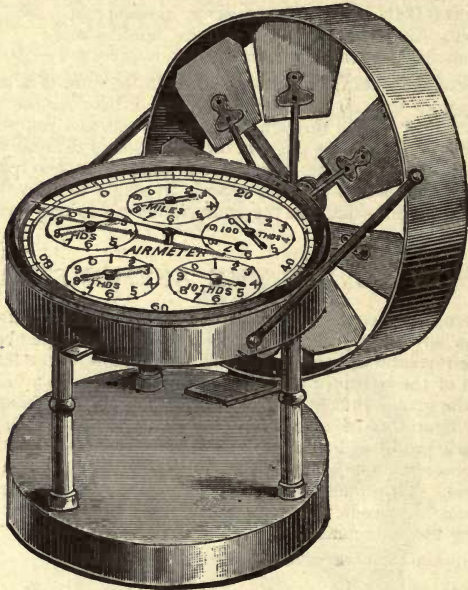

3397

No.		PRICE	Post.
3396	Air Meter, with disconnector, fan-wheel $2\frac{3}{4}$ inches diameter, two dials reading to 1,000 feet.	\$19.50	\$0.35
3397	Air Meter, with disconnector, fan-wheel $2\frac{3}{4}$ inches diameter, six dials reading to 10,000,000 feet. . . .	21.75	.35

The portable Air Meter is for the measurement of currents of air through mines, tunnels, sewers and the ventilators of hospitals, public buildings, etc. The indications are obtained by means of a delicately poised fan-wheel, the recordings being commenced by the long hand, which traverses the extreme outer circumference of the main dial for the passage of one hundred feet of air. The enumeration is continued up to ten millions of feet (say 1,894 miles) by a series of smaller dials as shown in the illustration. A Disconnector, projecting from the band of the instrument, opposite the fan-wheel, serves to throw the mechanism out of gear, and arrest its action, when required. The instrument is packed, with universal jointed socket-holder, in a box about four inches square.

FIELD-GLASSES AND BINOCULAR TELESCOPES

The Field-glasses here described are of the best quality and especially adapted for tourists, engineers, military service, or general field use. They are achromatic, and are metal body covered with morocco, and have a case with strap. Some are designated by the diameter of the objectives, in French lines, eleven lines being equal to one inch.



3400

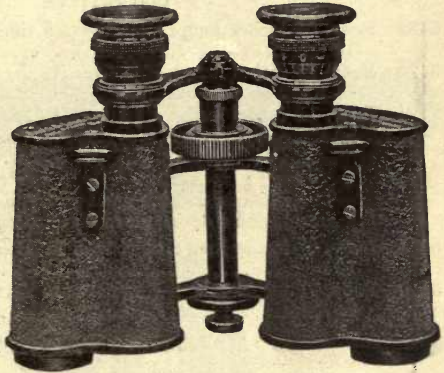

3442 with focusing attachment

FIELD-GLASS, GOOD QUALITY

No.		PRICE	Post.
3400	Body, $4\frac{3}{4}$ inches long ; objectives, 21 lines	\$7.00	\$0.30
3402	Body, $6\frac{1}{4}$ inches long ; objectives, 26 lines	9.00	.40

FIELD-GLASS, FINE QUALITY

3407	Body, $5\frac{7}{8}$ inches long ; objectives, 24 lines	\$14.00	\$0.45
3408	Body, $6\frac{1}{4}$ inches long ; objectives, 26 lines	15.00	.50

JENA FIELD-GLASS

NEW STYLE AND SUPERIOR

3410	Body, 6 inches long ; objectives, 26 lines	\$19.00	\$0.50
3411	Body, $5\frac{3}{8}$ inches long ; objectives, 24 lines and with hinge adjustment.....	20.00	.45

U. S. ARMY SIGNAL SERVICE FIELD-GLASS

VERY SUPERIOR

3413	Body, $6\frac{3}{8}$ inches long ; objectives, 24 lines	\$18.00	\$0.45
3414	Body, $6\frac{3}{8}$ inches long ; objectives, 26 lines	20.00	.50
3416	Body, $6\frac{3}{8}$ inches long ; objectives, 24 lines and with hinge adjustment.....	20.00	.45

GOERZ-TRIEDER-BINOCULAR

NEW STYLE, GREAT POWER

No.		PRICE	POST.
3418	Trieder-Binocular, No. 30, power 9 times.....	\$54.00	\$0.35
3419	Trieder-Binocular, No. 40, power 12 times.....	62.00	.40

BINOCULAR TELESCOPE

OLD PATTERN

3422	Body, 5 $\frac{1}{4}$ inches long; objectives, 8 lines; power 10 times.....	\$27.00	\$0.35
3423	Body, 9 $\frac{1}{2}$ inches long; objectives, 16 lines; power 16 times.....	45.00	.75
3424	Body, 11 inches long; objectives, 19 lines; power 20 times.....	50.00	.90

JENA BINOCULAR TELESCOPE

These binoculars have great power, a hinge adjustment, and a device for quick focusing.

3426	Body, 6 $\frac{3}{4}$ inches long; objectives, 11 lines; power 18 times.....	\$36.00	\$0.60
3428	Body, 7 $\frac{1}{4}$ inches long; objectives, 15 lines; power 24 times.....	45.00	.75

RANCHMAN'S GLASS

SUPERIOR QUALITY

3430	Body, 6 $\frac{3}{8}$ inches long; objectives, 26 lines.....	\$18.00	\$0.50
------	--	---------	--------

PANERGETIC GLASS

ALUMINUM BODY, NEW STYLE AND SUPERIOR

3434	Body, 4 inches long; objectives, 21 lines.....	\$23.00	\$0.30
3435	Body, 4 $\frac{1}{2}$ inches long; objectives, 24 lines.....	26.00	.35
3438	Body, 4 $\frac{1}{2}$ inches long; objectives, 24 lines, and with hinge adjustment.....	31.00	.35

BAUSCH & LOMB-ZEISS STEREO BINOCULAR

LATEST STYLE AND SUPERIOR

3442	Stereo Binocular, No. 8, power 8 times.....	\$47.50	\$0.35
3443	Stereo Binocular, No. 12, power 12 times.....	67.50	.40

If with focusing attachment, as shown on page 427, add \$5.00 extra.

BAUSCH & LOMB PLAIN BINOCULAR

SUPERIOR QUALITY

3446	Plain Binocular, No. 8, power 8 times.....	\$40.00	\$0.35
3447	Plain Binocular, No. 10 $\frac{1}{2}$, power 10 $\frac{1}{2}$ times.....	48.00	.40

If with focusing attachment, add \$5.00 extra.

PRISM TERRESTRIAL TELESCOPE

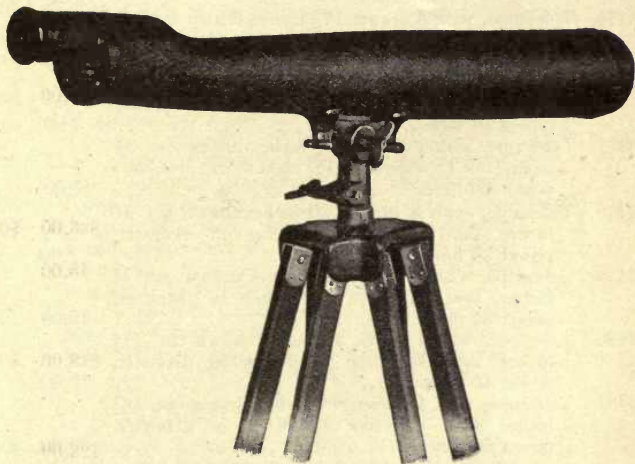

3470

- | No. | | PRICE |
|------|--|---------|
| 3470 | Telescope $21\frac{1}{2}$ inches long, objective 2 inches in diameter, two eyepieces with powers of 24 and 40 times; folding tripod. The telescope and tripod are contained in a leather-covered carrying case, $24 \times 6\frac{1}{2} \times 4\frac{1}{2}$ inches. | \$80.00 |
| | This Porro Prism instrument represents the highest development in terrestrial telescopes. It bears the same relation to the ordinary telescope which the prism binocular bears to the old style field-glass. The telescope tube and alt-azimuth mountings are of aluminum, and the workmanship is superior in every respect. | |

ACHROMATIC TELESCOPES

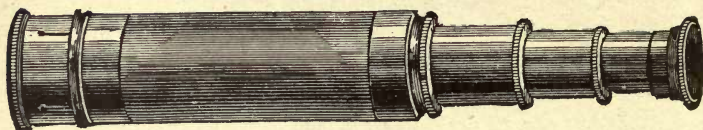

3475

No.		PRICE	POST.
3475	Telescope, with 3 draws, $17\frac{1}{4}$ inches drawn out, $6\frac{1}{2}$ inches shut, objective 1 inch in diameter, power 13 times.....	\$2.50	\$0.20
3476	Telescope, with 3 draws, $18\frac{3}{4}$ inches drawn out, 7 inches shut, objective $1\frac{1}{8}$ inches in diameter, power 16 times.....	3.50	.25
3477	Telescope, with 3 draws, $23\frac{3}{4}$ inches drawn out, $8\frac{1}{2}$ inches shut, objective $1\frac{3}{8}$ inches in diameter, power 20 times.....	5.00	.30
3478	Telescope, with 3 draws, 30 inches drawn out, 10 inches shut, objective $1\frac{5}{8}$ inches in diameter, power 25 times.....	7.00	.40
3479	Telescope, with 4 draws, 37 inches drawn out, 11 inches shut, objective $1\frac{7}{8}$ inches in diameter, power 35 times.....	10.00	.65
3480	Telescope, with 4 draws, 42 inches drawn out, $11\frac{1}{2}$ inches shut, objective $2\frac{1}{8}$ inches in diameter, power 40 times.....	17.00	.85
3481	Telescope, with 4 draws, 48 inches drawn out, $13\frac{1}{2}$ inches shut, objective $2\frac{3}{8}$ inches in diameter, power 50 times.....	30.00	

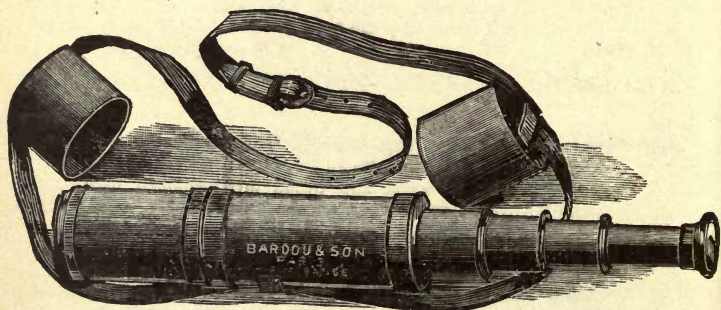

3485 See page 431.

TOURISTS' ACHROMATIC TELESCOPES

No.		PRICE	Post.
3485	Telescope, with brass body covered with morocco ; three draws, 17 inches drawn out, 6 inches shut ; objective $1\frac{1}{4}$ inches in diameter ; sun-shade ; leather caps to cover eyepiece and objective, and shoulder strap. Power 20 times.....	\$ 8.00	\$0.20
3486	Telescope, same as No. 3485, but is 21 inches drawn out, 7 inches shut ; objective $1\frac{5}{8}$ inches in diameter. Power 25 times.....	11.00	.30
3487	Telescope, same as No. 3485, but is 24 inches drawn out, 9 inches shut ; objective $1\frac{3}{4}$ inches diameter. Power 30 times.....	15.00	.40
3488	Telescope, same as No. 3485, but has four draws, 36 inches drawn out, 10 inches shut ; objective 2 inches in diameter. Power 35 times.....	22.00	.60
3492	Rifle Spy-glass, $10\frac{3}{4}$ inches drawn out ; body covered with morocco ; objective $\frac{1}{2}$ inch in diameter. Power 10 times.....	2.50	.15
3494	Wooden Tripod Stand, with vertical and horizontal motion, upon which to place a telescope. A useful article, as a telescope of much power cannot be held in the hand with sufficient steadiness.....	5.00	
3496	Brass Clamp with Gimlet Screw, to fasten a telescope to a post or tree ; sizes to fit telescopes Nos. 3475 to 3488. Price according to size	\$1.50, 2.00, 2.50, 3.00, 4.00 and	5.00 .15

ASTRONOMICAL TELESCOPES

3502	Astronomical Telescope, polished brass body, 35 inches long, mounted on brass tripod stand, achromatic objective $2\frac{3}{4}$ inches in diameter, one terrestrial eyepiece, power 50 times, one celestial eyepiece, power 100 times, rack and pinion for focusing. In box with lock.....	75.00	
3506	Astronomical Telescope, polished brass body, 35 inches long, rack and pinion for focusing, achromatic objective $2\frac{1}{2}$ inches in diameter, terrestrial eyepiece, power 40 times, celestial eyepiece with darkener, power 80 times, wooden tripod with horizontal and vertical motion. In box with lock, for receiving the body and eyepieces.....	75.00	
3508	Astronomical Telescope. Same as No. 3506, but with body 40 inches long, achromatic objective 3 inches in diameter, terrestrial eyepiece, power 55 times, celestial eyepiece with darkener, power 110 times. In box with lock.....	100.00	

POCKET MAGNIFIERS

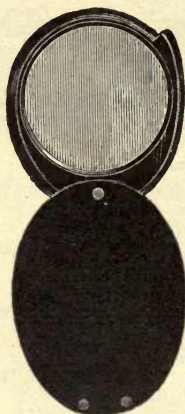

3520

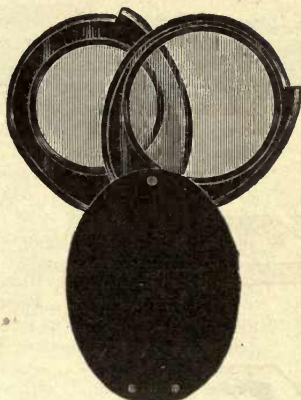

3526

RUBBER CASE, OVAL FORM, 1 DOUBLE-CONVEX LENS

No.		PRICE	POST.	No.		PRICE	POST.
3520	1-inch	\$0.40	\$0.02	3522	1½-inch	\$0.70	\$0.03
3521	1¼-inch60	.02	3523	2-inch	1.15	.12

RUBBER CASE, OVAL FORM, 2 DOUBLE-CONVEX LENSES

3526	7⁄8 and 1-inch..	.65	.03	3528	1¼ and 1½-inch,	1.10	.12
------	------------------	-----	-----	------	-----------------	------	-----

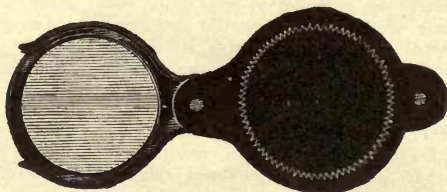

3530

RUBBER CASE, BELLOWS FORM, 1 DOUBLE-CONVEX LENS

3530	¾-inch40	.02	3532	1-inch60	.02
------	------------------	-----	-----	------	------------------	-----	-----

RUBBER CASE, BELLOWS FORM, 2 DOUBLE-CONVEX LENSES

3534	5⁄8 and ¾-inch .	.60	.02	3536	7⁄8 and 1-inch..	1.00	.12
------	------------------	-----	-----	------	------------------	------	-----

RUBBER CASE, BELLOWS FORM, 3 DOUBLE-CONVEX LENSES

No.	PRICE	POST.	No.	PRICE	POST.
3538	$\frac{1}{2}$, $\frac{5}{8}$, and $\frac{3}{4}$ -in.	\$0.80	3539	$\frac{3}{4}$, $\frac{7}{8}$, and 1-in.	\$1.30
3542	White Celluloid Case, oval form, one 1-inch double-convex lens.80	.02
3543	White Celluloid Case, oval form, one $1\frac{1}{4}$ -inch double-convex lens.			1.00	.03
3550	German Silver Case, oval form, one 1-inch double-convex lens.75	.04
3555	Microscope, brass mounted, on three legs, adjustable. .			.75	.05

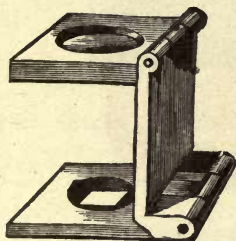

3560



3566

3560	Linen Prover, for counting threads in linen fabrics, brass mounted, $\frac{1}{4}$ -inch square open space.50	.02
3561	Linen Prover, for counting threads in linen fabrics, brass mounted, $\frac{1}{10}$ -inch round open space.50	.02
3562	Linen Prover, for counting threads in linen fabrics, brass mounted, $\frac{1}{10}$ -inch round and $\frac{1}{4}$ -inch square open spaces.60	.02
3565	Linen Prover, for counting threads in linen fabrics, brass mounted, 1-inch square open space.	2.00	.13
3566	Coddington Lens, brass mounted, small.	1.00	.12
3567	Coddington Lens, brass mounted, medium.	1.35	.14
3568	Coddington Lens, brass mounted, large.	1.75	.15
3569	Aplanatic Magnifier, high power, and flat field.	1.00	.12

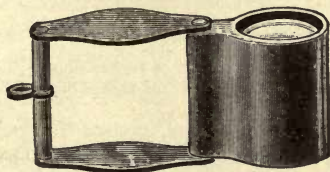

3570



No.		PRICE	Post.
3570	Coddington Lens, nickeled frame and cover, $\frac{1}{2}$ -inch diameter.....	\$1.50	\$0.12
3571	Coddington Lens, nickeled frame and cover, $\frac{3}{4}$ -inch diameter.....	1.75	.12
3572	Coddington Lens, nickeled frame and cover, 1-inch diameter.....	2.00	.12
3575	Aplanatic Triplet, nickeled frame and cover, superior quality, giving perfect definition, $\frac{1}{2}$ -inch focus, power 20 times.....	5.00	.12
3577	Aplanatic Triplet, nickeled frame and cover, superior quality, giving perfect definition, 1-inch focus, power 10 times.....	5.00	.12

Lenses Nos. 3566 to 3577 have extra power and definition for examining minerals, ore, rock, flowers, etc.

READING-GLASSES

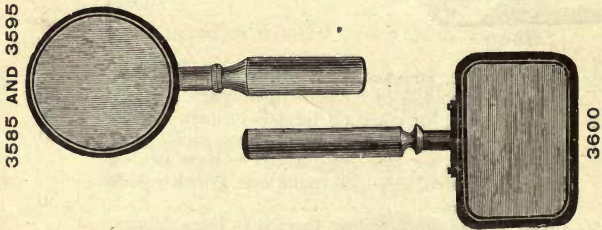

READING-GLASS, METAL FRAME, DOUBLE-CONVEX LENS

No.	PRICE	Post.	No.	PRICE	Post.
3585	2 inches diam.. \$0.80	\$0.05	3589	4 inches diam.. \$2.50	\$0.18
3586	2 $\frac{1}{2}$ inches diam. 1.00	.13	3591	5 inches diam.. 4.00	.35
3587	3 inches diam.. 1.50	.15	3593	6 inches diam.. 6.00	.40

READING-GLASS, METAL FRAME, TWO PLANO-CONVEX LENSES

3595	2 inches diam.. 1.25	.15	3597	3 inches diam.. 2.25	.20
3596	2 $\frac{1}{2}$ inches diam. 1.50	.18	3598	3 $\frac{1}{2}$ inches diam. 3.25	.25

READING-GLASS, OBLONG METAL FRAME, DOUBLE-CONVEX LENS

3600	2 $\frac{3}{4}$ x 1 $\frac{1}{2}$ inches.. 1.50	.13	3602	3 $\frac{1}{4}$ x 1 $\frac{1}{2}$ inches.. 2.00	.18
3601	3 x 1 $\frac{1}{2}$ inches.. 1.75	.15	3603	3 $\frac{1}{2}$ x 1 $\frac{3}{4}$ inches.. 2.50	.20

POCKET SPIRIT-LEVELS. French Make

PLAIN VIALS, MOUNTED IN BRASS

No.		PRICE	Post.	No.		PRICE	Post.
3650	3 inches.....	\$0.50	\$0.06	3652	9 inches.....	\$1.50	\$0.23
3651	6 inches.....	1.00	.18	3653	12 inches.....	2.00	.28

POCKET SPIRIT-LEVELS

A superior article. Our own make, with ground and graduated vial, mounted in brass and adjustable, and in wood case.



3660

3660	6 inches.....	\$3.50	\$0.18	3664	10 inches.....	\$4.50	\$0.25
------	---------------	--------	--------	------	----------------	--------	--------

LEVEL-VIALS, UNMOUNTED

OUR OWN MAKE, AND EVERY ONE TESTED



3675

3675 Ground and Graduated Level-Vials, unmounted: *

1½ inches.....	\$0.45	2 inches.....	\$0.50	2½ inches ...	\$0.60
3 inches.....	.75	3½ inches.....	.90	4 inches	1.05
4½ inches.....	1.00	5 inches.....	1.45	5½ inches	1.65
6 inches.....	1.80	6½ inches.....	2.00	7 inches	2.25

3690 Ground Level-Vials, not graduated, unmounted: *

1 to 1½ inches.	.35	2 inches.....	.40	2½ inches50
3 inches.....	.60	3½ inches.....	.75	4 inches90
4½ inches.....	1.20	5 inches.....	1.25	5½ inches	1.40
6 inches.....	1.50	6½ inches.....	1.65	7 inches	1.85

3710 Plain Level-Vials, not graduated, unmounted: *

1 to 1½ inches.	.10	2 inches.....	.12	2½ inches13
3 inches.....	.15	3½ inches.....	.18	4 inches20
4½ inches.....	.25	5 inches.....	.35	5½ inches40
6 inches.....	.50	6½ inches.....	.60	7 inches75

If sent by mail, the postage on unmounted level-vials, 1½ to 7 inches, will be 3 cents to 18 cents, according to size.

* When ordering, mention the extreme length and diameter required.

CARPENTERS' AND MASONS' SPIRIT-LEVELS

No.		PRICE
3726	Cherry Body, 26 inches long, with level and plumb vials. . .	\$0.75
3727	Cherry Body, 28 inches long, with level and plumb vials. . .	.85
3730	Cherry Body, 26 inches long, brass ends, both vials adjustable	1.25
3731	Cherry Body, 28 inches long, brass ends, both vials adjustable	1.35
3734	"Handy" Plumb and Level, cherry body, 26 inches long, brass ends, adjustable vials.	1.50
3738	Mahogany Body, 28 inches long, brass ends, adjustable vials .	1.75
3740	Iron Frame, 22 inches long, adjustable vials. Superior. . .	3.50

OILSTONES

	PRICE	POST.
3765	Arkansas Oilstones, fine quality for drawing-pens. .	\$0.25 \$0.03
3766	Arkansas Oilstones, fine quality, 3½ x 1 inch, in mahogany block with cover.75 .10
3768	Arkansas Oilstones, fine quality, 5 x 2 inches, in mahogany block with cover.	2.00 .25
3773	Washita Oilstones, common, 3½ x 1 inch, in cherry block with cover.45 .10
3775	Washita Oilstones, common, 5 x 2 inches, in cherry block with cover.75 .20

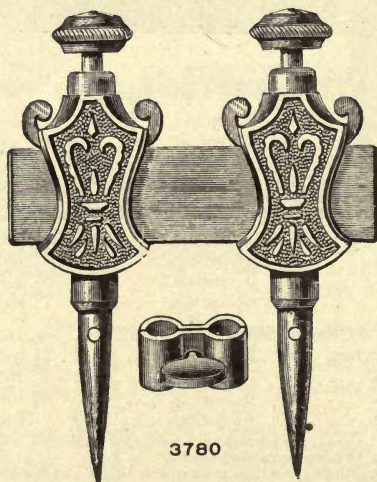

3780

IMPROVED TRAMMEL POINTS

See page 437.

No.		PRICE	POST.
3780	Trammel Points, small, No. 1, see page 436.....	\$1.00	\$0.15
3781	Trammel Points, medium, No. 2.....	1.25	.20
3782	Trammel Points, large, No. 3.....	1.65	.25
3800	Machinists' Tools, Lathe and Drill-Chucks and Drills, Steel Squares and Gauges, Brass Tubing and Wire, Sheet Brass and German Silver, Stubs' Steel Wire, etc., etc., at manufacturers' prices.		

STEEL MAGNETS

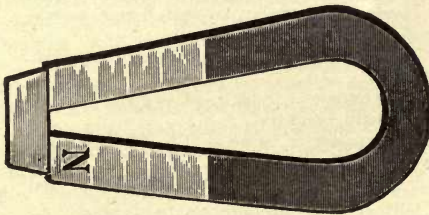

3850

No.		PRICE	POST.	No.		PRICE	POST.
3850	2 inches	\$0.12	\$0.03	3856	5 inches	\$0.50	\$0.10
3852	3 inches20	.04	3858	6 inches75	.13
3854	4 inches35	.06	3860	7 inches	1.10	.20

BRASS BLOW-PIPES

PLAIN

WITH BULB

3865	8 inches ...	\$0.15	\$0.05	3875	8 inches ...	\$0.30	\$0.05
3867	10 inches20	.06	3877	10 inches35	.06
3869	12 inches25	.07	3879	12 inches40	.07

THERMOMETERS IN JAPANED CASES

OPEN AIR SCALE

COMMON

FINE QUALITY

3890	6 inches ...	\$0.40	\$0.06	3900	7 inches ...	\$0.60	\$0.08
3892	8 inches50	.10	3901	8 inches75	.12
3894	10 inches60	.12	3903	10 inches ...	1.00	.15
3896	12 inches70	.18	3905	12 inches ...	1.25	.25
3910	8 inches, fine quality, with boiling scale90	.12				
3912	10 inches, fine quality, with boiling scale	1.25	.25				

THERMOMETERS WITH FANCY WOOD BACKS

OPEN AIR SCALE

OAK BACK				MAHOGANY BACK			
No.		PRICE	Post.	No.		PRICE	Post.
3920	8 inches...	\$1.00	\$0.18	3930	8 inches...	\$1.25	\$0.18
3922	10 inches...	1.35	.20	3932	10 inches...	1.50	.20
3924	12 inches...	2.00	.25				
3935	Pocket Thermometer, folding wood case, 5-inch....	1.00	.12				
3936	Pocket Thermometer, mahogany case, 6-inch, revers- ible scale, fine quality.....	1.85	.15				
3938	Pocket Thermometer, in metal tube, nickel-plated, 5-inch.....	.85	.12				
3940	Window Thermometer, 8-inch, plate-glass, 30° be- low zero, with brackets.....	1.25	.25				
3941	Window Thermometer, same as No. 3940, but 50° below zero.....	1.50	.25				
3943	Brewers' Copper Case Thermometer, 12-inch and deep cup.....	2.50	.30				
3945	Dairy Thermometer, all glass, floating, 8-inch.....	.35	.07				
3950	Chemical Thermometer, all glass, 60° to 300°, 14-inch.....	3.75	.25				
3952	Chemical Thermometer, all glass, 60° to 400°, 14-inch.....	4.00	.25				
3954	Chemical Thermometer, all glass, 60° to 500°, 14-inch.....	4.25	.25				

SELF-REGISTERING THERMOMETERS

3960	Maximum Thermometer, 10-inch, wood back.....	\$2.75	\$0.20
3962	Maximum Thermometer, U. S. Weather Bureau pattern, 12-inch, aluminum back.....	5.00	.20
3965	Minimum Thermometer, 10-inch, wood back.....	2.25	.20
3967	Minimum Thermometer, U. S. Weather Bureau pattern, 12-inch, aluminum back.....	4.25	.20
3970	U. S. Weather Bureau set of Maximum and Mini- mum Thermometers, 12-inch, aluminum back, and mounted together on one wood back.....	9.50	.50
3975	Mason's Hygrometer, consisting of dry and wet bulb thermometers mounted on one wood back.....	2.50	.30

All these Thermometers have the Fahrenheit scale.

RAIN GAUGES

No.		PRICE
3980	Smithsonian Rain Gauge, of capacity for 1-inch rainfall. This gauge is made of brass and is the most simple in its construction of any now in use. It has a measuring-stick which reads to 10ths and 100ths of inches; also a wooden cylinder to insert in the ground for the protection and ready adjustment of the instrument	\$5.00
3981	U. S. Weather Bureau Standard Rain and Snow Gauge of galvanized iron, 8-inch diameter, 25½ inches high, with measuring-stick. The receiver has a capacity for 2 inches of rainfall, and in connection with the overflow the possible capacity is 20 inches of rainfall. The Gauge is so adjusted that the reading is magnified 10 times and 1 inch of rainfall actually measures 10 inches on the stick. .	6.00
3982	Howard's Rain Gauge, consisting of a vertical glass bottle, through the neck of which the terminal tube of a galvanized iron funnel, 5 inches in diameter, is inserted. A glass graduate, measuring to 100ths of an inch, is furnished with the instrument.	4.00

MINERS' WATER GAUGE

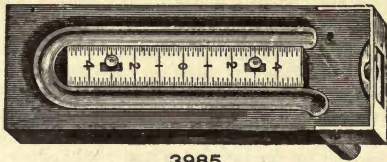

3985

No. 3985 Miners' Water Gauge, for ascertaining the ventilating air-pressure spent on airways in mines.

PRICE POST.
\$3.75 \$0.25

MINERS' LAMPS



3987

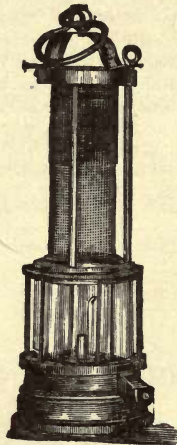

3988

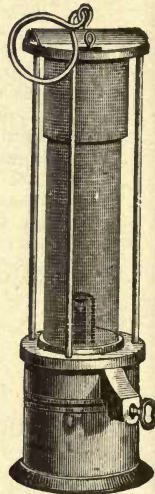

3989

3987 Miners' Lamp (copper), size No. 2.
3988 Miners' Safety Lamp (Newcastle Davy Lamp)
3989 Miners' Safety Lamp (English Clanny Lamp, bonneted)

\$0.30 \$0.10
2.50
3.00

HYDROMETERS

WITH BAUME'S SCALE

3990 Hydrometers, for testing Acid, Alkalies, Ammonia, Bark, Beer, Ether Milk, Molasses, Oils, Salt Water, Spirits, Syrup, Urine, Vinegar. Each . . .
3995 Twaddell's Hydrometers, Nos. 1 to 6, with scales respectively 0 to 24, 24 to 48, 48 to 72, 72 to 100, 100 to 134, 134 to 180, each graduation representing five degrees of specific gravity. Each . . .

\$0.75 \$0.10
.75 .10

SCIENTIFIC BOOKS

FOR SALE BY

W. & L. E. GURLEY

TROY, N. Y., U. S. A.

Architecture, Carpentry and Building, Astronomy, Bridges, Roofs and Tunnels, Chemistry and Physics, Construction, Strength of Materials, Drawing, Electricity and Telegraphy, Geology, Mining and Metallurgy, Hydraulic and Sanitary Engineering, Machinery and Mechanics, Pocket Table-Books, Surveying and Engineering Instruments, Etc.

Parties ordering should either send drafts on New York, or postal orders on Troy, N. Y.; or if money is enclosed in letters, such letters should be registered at the post-office where mailed.

We prepay postage on nearly all American and English books when the price is sent to us in advance.

Books can be registered at an extra cost of eight cents for each package of not over four pounds.

Orders for over \$10 will be sent by express C. O. D. if desired; but for smaller sums, parties will please remit the necessary amount with their order.

Write all letters legibly, give your Post-office, County and State, and be sure to sign your letter before mailing.

We are not responsible for loss of goods sent by mail.

Should any other works on kindred topics be desired, we will furnish them at publishers' prices.

ARCHITECTURE, CARPENTRY, AND BUILDING

	PRICE
BALDWIN, W. J. Steam-Heating for Private Houses and Large Buildings. 12mo. 404 pages. 131 illustrations.....	\$2.50
BERG, W. G. Buildings and Structures of American Railroads. 4to. 534 pages. 700 illustrations.....	5.00
BUEL, A. W., and HILL, C. S. Reinforced Concrete in Building Construction. 8vo. 443 pages. 311 illustrations.....	5.00
BULLOCK, J. Rudiments of Architecture and Building. 8vo. 468 pages. 250 illustrations.....	2.50
CARPENTER, R. C. The Heating and Ventilating of Buildings. 8vo. 578 pages. 277 illustrations.....	4.00
FREITAG, J. K. Architectural Engineering, and High Building Construction. 8vo. 421 pages. 196 illustrations.....	3.50
GRAVES, H. S. Forest Mensuration. 8vo. 472 pages. Illustrated.....	4.00
GREEN, S. B. Principles of American Forestry. 12mo. 347 pages. Illustrated.....	1.50
HURST, J. T. Hand-Book for Architectural Surveyors.....	2.00
KEMP, EDWARD. Landscape Gardening. 403 pages. 204 illustrations. 12mo.....	2.50
KIDDER, F. E. Building Construction and Superintendence. Part I. Masons' Work. 8vo. 421 pages. 260 illustrations.	4.00
KIDDER, F. E. Building Construction and Superintendence. Part II. Carpenters' Work. 8vo. 544 pages. 524 illustrations.....	4.00
REID, H. A. Concrete and Reinforced Concrete Construction. 8vo. 800 pages. 700 illustrations.....	5.00
TAYLOR, F. W., and THOMPSON, S. E. Treatise on Concrete, plain and reinforced. 8vo. 585 pages. Illustrated...	5.00

ASTRONOMY

BOWDITCH, N. American Practical Navigator. An Epitome of Navigation and Nautical Astronomy. 8vo.....	\$2.75
CHAUVENET, WM. Spherical and Practical Astronomy; and the Theory and Use of Fixed Astronomical Instruments. 2 vols., royal 8vo.....	7.00
COMSTOCK, G. C. Field Astronomy for Engineers. 8vo.....	2.50
NAUTICAL Almanac. Published by authority of the Secretary of the Navy, Washington. Each year.....	.75
NAUTICAL Almanac and Ephemeris. Large 8vo. Each year.	1.50
NEWCOMB, S. Popular Astronomy, with 112 engravings and 5 maps of the stars. 8vo.....	1.75
PROCTOR, R. A. Half-Hours with the Telescope. 12mo. Illustrated.....	1.25
PROCTOR, R. A. Half-Hours with the Stars. A plain and easy guide to the knowledge of the constellations, with explanation of each map. True for every year. Demy 4to.....	2.00

BRIDGES, ROOFS, ETC.

	PRICE
BENDER, C. B. Principles of Economy in the Design of Metallic Bridges, including Cantilever Bridges. 195 pages. 12 plates..	\$2.50
BOLLER, A. P. Practical Treatise on the Construction of Iron Highway Bridges. Illustrated. 8vo.....	2.00
BURR, WM. H. Stresses in Bridges and Roof Trusses, Arched Ribs and Suspension Bridges. 501 pages. Illustrations and 13 plates. 8vo.....	3.50
FOSTER, W. C. Wooden Trestle Bridges. The present practice on American railroads. 4to. 255 pages. 164 illustrations. 47 plates.....	5.00
GREENE, C. E. Roof Trusses. Diagrams for Steady Load, Snow and Wind. 8vo.....	1.25
GREENE, C. E. Bridge Trusses. Single, Continuous, and Draw-spans; Single and Multiple Systems; Straight and Inclined Chords. 8vo. Illustrated. 10 plates.....	2.50
GREENE, C. E. Arches in Wood, Iron, and Stone, for Roofs, Bridges, and Wall openings; Arched Ribs and Braced Arches, Stresses from Wind and change of Temperature. 8vo. 190 pages. 60 illustrations. 8 plates.....	2.50
HAUPT, H. Military Bridges; Trestle and Truss Bridges. 8vo.	6.50
HOWE, M. A. Treatise on Arches. 8vo. 367 pages. 74 illustrations.....	4.00
MERRIMAN, M. Text Book on Roofs and Bridges. Part 1. Stresses in Simple Trusses. 8vo. 316 pages. 211 illustrations.....	2.50
MERRIMAN, M. Text Book on Roofs and Bridges. Part 2. Graphic Statics. 8vo. 234 pages. 138 illustrations.....	2.50
MERRIMAN, M. Text Book on Roofs and Bridges. Part 3. Bridge Design. 8vo. 374 pages. 149 illustrations and 18 plates.....	2.50
MERRIMAN, M. Text Book on Roofs and Bridges. Part 4. Higher Structures. 8vo. 374 pages. 181 illustrations.....	2.50
PRELINI, CHARLES. Tunneling; A Practical Treatise on Earth, Rock and Submarine Tunneling. 8vo. 311 pages. 150 illustrations.....	3.00
SHREVE, S. H. Strength of Bridges and Roofs. With practical applications and examples. 89 cuts. 8vo.....	3.50
WHIPPLE, S. Bridge Building. Practical Treatise on Iron and Wooden Bridges. 8vo. 352 pages. Illustrated.....	3.00
WRIGHT, C. H. Designing of Draw-Spans. 8vo. 317 pages. Illustrations and plates.....	3.50

CHEMISTRY, PHYSICS, ETC.

	PRICE
ADRIANCE, J. S. Laboratory Calculations and Specific-Gravity Tables. 12mo. 150 pages.....	\$ 1.25
ATTFIELD, J. Chemistry, General, Medical, and Pharmaceutical. 12mo.....	2.75
CHURCH, A. H. The Laboratory Guide; Practical Chemistry for Colleges and Schools, and Agricultural Students. 12mo...	2.50
CLASSEN-BOLTWOOD. Quantitative Chemical Analysis by Electrolysis. 8vo. 315 pages. Illustrated.....	3.00
EISSLER, M. Modern High Explosives. 8vo. 395 pages. Illustrated.....	4.00
FLETCHER, E. L. Practical Instruction in Quantitative Assaying with the Blowpipe. 12mo.....	1.50
FRESENIUS-WELLS. Qualitative Chemical Analysis. Revised edition. 8vo. 748 pages.....	5.00
GANOT-ATKINSON. Elementary Treatise on Physics, experimental and applied. 8vo. 1057 illustrations.....	5.00
PLATTNER, T. H. Blowpipe Analysis. Illustrated. 560 pages. 8vo.....	5.00
PRESCOTT, A. B. First Book in Quantitative Chemistry. 12mo..	1.50
WILSON, E. B. Cyanide Processes. 12mo. 206 pages.....	1.50

CONSTRUCTIONS, STRENGTH OF MATERIALS, ETC.

ANDREWS, H. B. Hand-book for Street Railway Engineers. 16mo. 202 pages. Illustrated.....	\$ 1.25
BAKER, I. O. Treatise on Masonry Construction. With 160 engravings, 87 tables. 8vo. 600 pages.....	5.00
BAKER, I. O. Treatise on Roads and Pavements. 8vo. 655 pages. 171 illustrations, 68 tables.....	5.00
BURK, WM. H. Elasticity and Resistance of the Materials of Engineering. 1100 pages. 8vo. Illustrated.....	7.50
BYRNE, A. T. Highway Construction. The Location, Construction and Maintenance of Roads, Streets and Pavements. 1040 pages. 306 illustrations. 90 tables. 8vo.....	5.00
BYRNE, A. T. Inspection of Materials and Workmanship employed in construction. 540 pages.....	3.00
CAMP, W. M. Notes on Track. Construction and Maintenance. 8vo. 1214 pages. Nearly 600 illustrations.....	3.75
DUBOIS, PROF. A. J. Strains in Framed Structures. With numerous practical Applications to Cranes, Bridge, Roof and Suspension Trusses, Braced Arches, Pivot and Draw-Spans, Continuous Girders, etc. Fully illustrated. 4to. 618 pages..	10.00
GILLETTE, H. P. Earthwork and its Cost. 12mo. 256 pages. Illustrated.....	2.00
GILLETTE, H. P. Hand-book of Cost Data. 12mo. 640 pages. Illustrated.....	4.00

	PRICE
GILLETTE, H. P. Rock Excavation. Methods and Cost. 12mo. 402 pages. Illustrated.....	\$3.00
GILLMORE, GEN. Q. A. Treatise on Limes, Hydraulic Cements, and Mortars. Papers on Practical Engineering, U. S. Engineer Department. 8vo. 334 pages.....	4.00
HATFIELD, R. G. Theory of Transverse Strains in the Construction of Buildings, Iron Girders, Roofed Trusses, etc. 8vo..	5.00
HOWE, M. A. Retaining-walls for Earth. 12mo.....	1.25
JUDSON, W. P. City Roads and Pavements. 8vo. 196 pages. Illustrated.....	2.00
MOLITOR, F. M., and BEARD, E. J. Manual for Resident Engineers. 16mo. 118 pages.....	1.00
PAINE, G. H. Roadmaster's Assistant. A Manual of Maintenance of Way. 16mo.....	1.50
PATTON, W. M. Practical Treatise on Foundations. 8vo. 549 pages. 135 illustrations.....	5.00
JERVIS, J. B. Railway Construction and Management. 12mo..	2.00
JOHNSON, J. B. The Designing of Modern Framed Structures. 4to. 527 pages. 450 illustrations. 40 plates.....	10.00
SHIELDS, J. E. Notes on Engineering Construction, and description of the materials employed in Tunneling, Bridging, Canal, and Road Building, etc. Illustrated. 12mo.....	1.50
SPALDING, F. P. Text-Book on Roads and Pavements. 12mo..	2.00
TRATMAN, E. E. R. Railway Track and Track-work. 472 pages. 226 illustrations. 8vo.....	3.50
WEBB, WALTER L. Railroad Construction; Theory and Practice. 16mo. 727 pages. 216 illustrations. 10 plates.....	5.00
WEBB, WALTER L. Economics of Railroad Construction. 12mo. 347 pages. 34 illustrations.....	2.50
WOOD, DE VOLSON. Resistance of Materials, and an appendix on the Preservation of Timber. 8vo. 314 pages. Illustrated..	2.00

DRAWING

ANDRE, G. G. Draughtsman's Hand-Book of Plan and Map Drawing. With instructions for Engineering, Architectural, and Mechanical Drawing. Illustrated. 33 plates. 8vo....	\$3.75
ANTHONY, G. C. Mechanical Drawing. 98 pages. 32 plates..	1.75
ANTHONY, G. C. Machine Drawing. 56 pages. 18 plates..	1.75
BROWN, G. E. Ferric and Heliographic Processes. Illustrated..	1.00
CHURCH, A. E. Elements of Descriptive Geometry; Spherical Projections, Shades and Shadows, Perspective and Isometric Projections. 8vo., and Atlas of Plates, 4to.....	3.50
COOLIDGE-FREEMAN. Elements of General Drafting for Mechanical Engineers. 8vo., oblong. 55 pages. 21 plates..	2.50

	PRICE
CROMWELL, J. H. System of Easy Lettering.....	\$0.50
EDMINSTER, C. F. Architectural Drawing. 12mo., oblong. 231 pages. 105 plates.....	2.00
ESSER. Draughtsman's Alphabets. Oblong.....	1.50
JACOBY, H. S. Text-Book on Plain Lettering. 8vo., oblong. 82 pages. 48 plates.....	3.00
MAHAN, D. H. Industrial Drawing; Comprising the Description and Uses of Drawing Instruments, the Construction of Plane Figures, the Projections and Sections of Geometrical Solids, Architectural Elements, Mechanism and Topographical Drawing. Revised by Prof. D. F. Thompson. 1 vol. 209 pages, and Atlas of Plates. 8vo. New edition.....	3.50
MAXTON, J. Manual of Engineering Drawing. 12mo.....	1.40
MINIFIE, WM. Mechanical Drawing, including an Introduction to Isometrical Drawing, and an Essay on Linear Perspective and Shadows. 200 illustrations. 8vo.....	4.00
MINIFIE, WM. Geometrical Drawing—an abridgment of "Mechanical Drawing." 12mo.....	2.00
REED, H. A. Topographical Drawing and Sketching, and Pho- tography applied to Surveying. 226 pages. Illustrated and with 25 plates. 4to.....	5.00
REINHARDT, C. W. Lettering for Draughtsmen, Engineers and Students. 8vo. Oblong.....	1.00
REINHARDT, C. W. Technic of Mechanical Drawing. 8vo. oblong. 36 pages. 62 illustrations. 10 plates.....	1.00
ROSE, JOSHUA. Mechanical Drawing Self-taught, Elementary Instruction in Practical Drawing. 330 illustrations. 8vo....	4.00
SMITH, R. S. Manual of Topographical Drawing. Revised and enlarged by Chas. McMillan, C. E. Illustrated. 8mo...	2.50
STANLEY, W. F. Mathematical Drawing-Instruments; with hints upon Drawing and Coloring. 12mo.....	2.00
TUTHILL, W. B. Practical Lessons in Architectural Drawing. 8vo., and with 33 plates.....	2.50
WARREN, S. E. Drafting-Instruments and Operations. 12mo...	1.25
WARREN, S. E. Elements of Machine Construction and Draw- ing. 2 vols. 8vo. Text and plates.....	7.50
WARREN, S. E. Free-hand Drawing. 12mo.....	1.00
WARREN, S. E. General Problems of Shades and Shadows. 8vo..	3.00
WARREN, S. E. Manual of Projection Drawing. 12mo.....	1.50
WARREN, S. E. Manual of Linear Perspective. 12mo.....	1.00
WARREN, S. E. New Descriptive Geometry. 8vo.....	3.50
WARREN, S. E. Plane Problems in Elementary Geometry. 12mo.	1.25
WILSON, V. T. Free-hand Lettering. 8vo. 105 pages. Illus- trated	1.00

ELECTRICITY, TELEGRAPHY, ETC.

	PRICE
ATKINSON, P. Electric Lighting; including Electric Generation, Measurement, Storage, and Distribution. 264 pages. 104 illustrations. 12mo.....	\$1.50
BELL, LOUIS. Electrical Power Transmission. A Practical Treatise. 8vo. 721 pages. 341 illustrations.....	4.00
CROCKER, F. B. Electric Lighting; a Practical Treatise for Electricians and Students. 2 vols. 8vo. Illustrated.....	6.00
CROCKER, F. B., AND WHEELER, S. S. Management of Dynamos and Motors. 12mo. 210 pages. 100 illustrations..	1.00
DAWSON, PHILIP. Engineering and Electric Traction Pocket-Book. 16mo. 1,411 pages. 1,300 illustrations. 947 tables..	5.00
FISKE, LIEUT. B. A. Electricity in Theory and Practice; elements of electrical engineering. 270 pages. 176 illustrations. 8vo.	2.50
FOSTER, H. A. Electrical Engineer's Pocket-Book. 16mo. 1,000 pages. Fully illustrated.....	5.00
HOMANS, J. E. A B C of the Telephone. A Practical Treatise. 8vo. 352 pages. 269 illustrations	1.00
HERRICK, A. B. Practical Electric Railway Hand-Book. 300 pages. Illustrated	3.00
LOCKWOOD, T. D. Electricity, Magnetism, and Electric Telegraphy. General information for Electrical Students, Operators, and Inspectors. 8vo. 378 pages. 152 illustrations.....	2.50
POPE, F. L. Modern Practice of Electric Telegraph. 8vo. Illustrated.....	1.50
SLOANE, T. O'C. Standard Electrical Dictionary. 624 pages. 350 illustrations. 12mo.....	3.00
SLOANE, T. O'C. Arithmetic of Electricity. 12mo.....	1.00
SLOANE, T. O'C. Electricity Simplified. Illustrated. 12mo..	1.00
SPRAGUE, J. T. Electricity; its Theory, Sources, and Applications. New edition, with numerous illustrations. 647 pages..	6.00
URQUHART, J. W. Dynamo Construction. A practical Hand-book. 352 pages. 113 illustrations. 12mo.....	3.00

GEOLOGY, MINING, AND METALLURGY

BAUERMAN, H. Metallurgy of Iron. Outlines of the History of Iron Manufacture, Analysis of Iron Ores, etc. 12mo.....	\$2.00
BOWIE, A. J., JR. Practical Treatise on Hydraulic Mining, with Description of the Use and Construction of Ditches, Flumes, Wrought-iron Pipes, and Dams; Flow of Water on Heavy Grades, and its Applicability, under High Pressure, to Mining. 313 pages. 72 illustrations. 52 tables. 8vo.....	5.00

	PRICE
COAL and Metal Miners' Pocket-Book. 12mo. 637 pages. 300 illustrations.....	\$3.00
DANA, E. S. 'Minerals and How to Study Them. 12mo. 380 pages. 319 illustrations.....	1.50
DANA, E. S. Text-Book of Mineralogy. 8vo. 593 pages. 1,008 illustrations	4.00
DANA, J. D. Manual of Geology, treating especially of American Geological History. 8vo.....	6.00
DANA, J. D. Manual of Mineralogy and Petrography. 12mo. 517 pages. Illustrated.....	2.00
DANA, J. D. Text-Book of Geology. 12mo.....	2.50
FURMAN, H. VAN F. Manual of Practical Assaying. 8vo. 467 pages.....	3.00
IHLSENG, M. C. Manual of Mining, Mining Engineering, Practical Mining. 723 pages. 337 illustrations. 8vo.....	5.00
OSBORN, H. S. Prospector's Field-Book and Guide. New Edition. 12mo. 296 pages. Illustrated.....	1.50
VAN WAGENEN, T. F. Manual of Hydraulic Mining, for the Use of the Practical Miner. 18mo.....	1.00
WILSON, E. B. Practical Mine Ventilation. 16mo. Illustrated..	1.25

HYDRAULIC AND SANITARY ENGINEERING

ADAMS, J. W. Sewers and Drains for Populous Districts. Rules and Formulas for the Dimensions and Construction of Works of Sanitary Engineers. 8vo. 228 pages. Illustrated.....	\$2.50
BILLINGS, W. R. Details of Water-Works Construction. 8vo. Illustrated	2.00
BOX, THOMAS. Practical Hydraulics; Rules and Tables for the Use of Engineers, etc. 12mo. 100 pages. 49 illustrations..	2.00
ELLIOTT, C. G. Engineering for Land Drainage. 12mo. 240 pages. Illustrated	1.50
FANNING, J. T. A Practical Treatise on Water-Supply Engineering; relating to the Hydrology, Hydrodynamics, and Practical Construction of Water-works in North America. 8vo. 650 pages. 200 illustrations. 121 tables.....	5.00
FOLWELL, A. P. Water-Supply Engineering. 8vo. 570 pages, 95 illustrations, and 19 plates.....	4.00
FOLWELL, A. P. Sewerage; Designing, Construction, and Maintenance of Sewerage Systems. 8vo. 455 pages. Illustrated..	3.00
FRENCH'S Principles, Process and Effects of Draining Lands. Over 100 illustrations. 12mo.....	1.50

	PRICE
FRIZELL, J. P. Water-Power; Development and Application of the Energy of Flowing Water. 8vo. 646 pages. 251 illustrations.....	\$5.00
GOODRICH, W. F. Economic Disposal of Towns' Refuse. 8vo. 340 pages. Illustrated.....	3.50
HAZEN, ALLEN. Filtration of Public Water-Supply. 8vo. 333 pages. Illustrated.....	3.00
HILL, J. W. Purification of Public Water-Supplies. 8vo. 304 pages. Illustrated.....	3.00
HOYT, J. C., and Grover, N. C. Methods of Measuring and Computing River Discharge. 8vo. Illustrated.....	2.00
MEAD, ELWOOD. Irrigation Institutions. 12mo. 403 pages..	1.25
MERRIMAN, M. Treatise on Hydraulics, Hydrostatics, Hydraulic Motors, etc. Numerous tables and diagrams. 427 pages. 212 illustrations. 25 tables. 8vo.....	5.00
NEWELL, F. H. Irrigation in the United States. The Methods, Advantages, and Irrigation Law. 8vo. 417 pages. 156 illustrations.....	2.00
OGDEN, H. N. Sewer Design. 12mo. 234 pages. Illustrated..	2.00
RAFTER, G. W., and BAKER, M. N. Sewage Disposal in the United States. 600 pages. Illustrated and plates. 8vo....	6.00
STALEY-PIERSON. The Separate System of Sewerage. Theory and Construction. Illustrated. 8vo. 280 pages. 21 tables..	3.00
STEWART, H. Irrigation for the Farm, Garden, and Orchard. Illustrated. 276 pages. 12mo.....	1.50
TURNEAURE-RUSSELL. Public Water-Supplies. Requirements and Construction. 8vo. 746 pages. 231 illustrations..	5.00
WARING, G. E. Draining for Profit and Health. How to Lay Out and Construct a System of Drains. Illustrated. 12mo..	1.50
WARING, G. E. Modern Methods of Sewage Disposal. 252 pages. Illustrated. 12mo.....	2.00
WARING, G. E. Sanitary Drainage of Houses and Towns. 12mo.....	2.00
WARING, G. E. Sewerage and Land Drainage. 406 pages and 30 plates. 4to.....	6.00
WEGMANN, E., JR. The Design and Construction of Masonry Dams. 434 pages and 134 plates. 14 tables. 4to.....	6.00
WILLIAMS, G. S. and HAZEN, A. Hydraulic Tables. Showing loss of Head due to Friction of Water flowing in Pipes, Aqueducts, Sewers, etc., and Discharge over Weirs. 8vo. 78 pages.....	1.50
WILSON, H. M. Manual of Irrigation Engineering. Hydrography. Canals and Canal Work. Storage Reservoirs. 8vo. 614 pages. 148 illustrations. 41 plates.....	4.00

MACHINERY AND MECHANICS

	PRICE
APPLETON'S Dictionary of Mechanics. 5,000 engravings. Large 8vo. 2 vols., sheep binding.....	\$15.00
BOURNE, JOHN. A Catechism of the Steam-Engine. 12mo...	2.00
BOURNE, JOHN. Hand-Book of the Steam-Engine. A key to the "Catechism of the Steam-Engine." Illustrated. 12mo..	1.75
BROWN & SHARPE Mfg. Co. Gear Wheels and Gearing. Practical Treatise, with Tables. Illustrated. 8vo.....	1.00
CLARK, D. K. A Manual of Rules, Tables, and Data for Mechanical Engineers, based on the most recent investigations. Illustrated with numerous Diagrams. Large 8vo. 1,012 pages..	5.00
COOPER, J. H. Use of Belting for Transmission of Power. 8vo. Illustrated.....	3.50
FITZGERALD, W. S. The Boston Machinist. Illustrated....	1.00
FORNEY, M. N. Catechism of the Locomotive. 709 pages. 500 illustrations. 8vo.....	3.50
GOODEVE, T. M. Text-Book on the Steam-Engine. 12mo. 143 illustrations.....	2.00
HEMENWAY, F. F. Indicator Practice and Steam-Engine Economy. 12mo. 184 pages. Illustrated.....	2.00
HUGHES, WM. C. American Miller and Millwright's Assistant. 12mo.....	1.50
PRAY, THOS., JR. Twenty Years with the Indicator. 286 pages. 175 illustrations. 8vo.....	2.50
ROPER, S. Hand-Book of Land and Marine Engines, including their Modeling, Construction, and Management. 12mo.....	3.50
ROPER, S. Hand-Book of the Locomotive; Construction and Management of Locomotive Engines and Boilers. 12mo....	2.50
SCHUMANN, F. A Manual of Heating and Ventilation. Embracing a Series of Tables and Formulæ for dimensions of heating, flow and return pipes for steam and hot-water boilers, flues, etc. 12mo. Illustrated.....	1.50
THURSTON, R. H. Manual of Steam Boilers; Design, Construction and Operation. 8vo. 883 pages. 244 illustrations..	5.00
THURSTON, R. H. Manual of the Steam-Engine. Part I. Structure and Theory. 8vo. 1,000 pages. Illustrated.....	6.00
THURSTON, R. H. Manual of the Steam-Engine. Part II. Design, Construction, and Operation. 8vo. Illustrated.....	6.00

POCKET-BOOKS, TABLES, ETC.

	PRICE
ALLEN, C. F. Field and Office Tables. 12mo. 293 pages...	\$2.00
ALLEN, C. F. Railroad Curves and Earthwork, with tables and diagrams. 12mo. 194 pages.....	2.00
BOILEAU, J. T. Tráverse Tables; showing difference of latitude and departure to every minute of the quadrant. 8vo....	5.00
BRUHNS, DR. Manual of Logarithms to seven places of Decimals. 8vo.....	2.50
BURT, W. A. Key to the Solar Compass, and Surveyors' Companion. All the rules necessary for use in the field; Linear Surveys and Public Land System of the United States, Notes on the Barometer, suggestions for an outfit for a survey of four months, etc. 202 pages.....	2.50
BUTTS, EDWARD. Civil Engineers' Field-Book; designed for the Locating Engineer. With numerous tables.....	2.50
CLEVENGER, S. V. A treatise on the method of Government Surveying. With complete Mathematical, Astronomical, and Practical Instructions, for the use of United States Surveyors..	2.50
COX, WM. The Stadia Computer.....	.75
CRANDALL, C. L. Railway and other Earthwork Tables. 8vo..	1.50
CROCKETT, C. W. Logarithmic and Trigonometric Tables....	1.25
CROCKETT, C. W. Methods for Earthwork Computations. 8vo. 114 pages. 90 figures.....	1.50
DAVIS, A. P. Elevation and Stadia Tables. 8vo.....	1.00
GODWIN, H. C. Railroad Engineers' Field-Book on Exploring, Location and Construction. 357 pages. Illustrated. 20 tables..	2.50
GURDEN, R. L. Traverse Tables; Computed to four places of decimals and for every minute of angle up to 100 of distance. Size, 9 x 14, half morocco	7.50
HAMILTON, W. G. Useful Information for Railway Men. 562 pp..	2.00
HASWELL, C. H. Engineers' and Mechanics' Pocket-Book. Tables, Rules, and Formulas Pertaining to Mechanics, Mathematics and Physics, etc. 988 pages. 12mo.....	4.00
HENCK, J. B. Engineers' Field-Book. Containing Formulæ for laying out Curves, determining Frog Angles, Leveling, calculating Earthworks. 273 pages. 17 tables.....	2.50
HODGMAN, F. Surveyors' Tables; being the 21 tables as printed in Hodgman's Manual of Surveying. 16mo. 106 pages....	1.00
HOWARD, C. R. Earthwork Mensuration on the Basis of the Prismoidal Formulæ. 8vo. Illustrated.....	1.50
HUDSON, J. R. Excavation and Embankment Tables. 8vo....	1.00
KENT, WM. Mechanical Engineers' Pocket-Book. 1,113 pages. Illustrated. 12mo.....	5.00
KIDDER, F. E. Architects' and Builders' Hand-book. 1,763 pages. 1,000 illustrations.....	5.00
MERRIMAN, M., and BROOKS, J. P. Hand-book for Surveyors. Land Surveying, Leveling, Triangulation, Topography, Tables.....	2.00

	PRICE
MOLESWORTH, G. L. Pocket-Book of Formulæ for Engineers. .	\$2.00
NAGLE, J. C. Field Manual for Railroad Engineers. 16mo. 418 pages. 99 illustrations. 35 tables.....	3.00
PHILBRICK, P. H. Field Manual for Engineers. 388 pages. 152 illustrations.....	3.00
SEARLES, WM. H. Field Engineering. Railway Surveying, Location, and Construction. 503 pages. 108 illustrations. 31 tables.....	3.00
SEARLES, WM. H. The Railroad Spiral. Theory of the Com- pound Transition Curve reduced to practical Formulæ and Rules for Application in Field Work. Illustrated.....	1.50
SHUNK, W. F. The Field Engineer. A handy book of practice in the Survey, Location, and Track-work of Railroads, con- taining a large collection of Rules and Tables applicable to both the Standard and Narrow Gauge. 339 pages. 17 tables..	2.50
SHUNK, W. F. Treatise on Railway Curves.....	2.00
STILES, A. Tables for Field Engineers. Designed for use in the field. Tables containing all the functions of a one degree curve, from which a corresponding one can be found for any required degree, also tables of natural sines and tangents. 8vo..	2.00
SUPLEE, H. H. Mechanical Engineers' Reference Book. 12mo. 834 pages. Illustrated.....	5.00
TRAUTWINE, J. C. Excavations and Embankments. 8vo.....	2.00
TRAUTWINE, J. C. Railroad Curves. 192 pages. 14 tables..	2.50
TRAUTWINE, J. C. Civil Engineers' Pocket-Book of Mensura- tion, Trigonometry, Surveying, Hydraulics, Hydrostatics, Strength of Materials, Masonry, Principles of Wooden and Iron Roof and Bridge Trusses, Stone Bridges and Culverts, Trestles, Pillars, Suspension Bridges, Dams, Railroads, Turn- outs, Turning Platforms, Water Stations, Cost of Earthwork, Foundations, Retaining Walls, etc. 1,079 pages. Illustrated..	5.00
VEGA, BARON VON. Logarithmic Tables, from 1 to 100,000 to seven figures. 8vo. 575 pages.....	2.50
WADDELL, J. A. L. De Pontibus. A Pocket-Book for Bridge Engineers, with tables and plates.....	2.00

SURVEYING AND ENGINEERING

BEAHAN, W. Field Practice of Railway Location. 8vo. 270 pages. Illustrated	\$3.00
BROUGH, B. H. Treatise on Mine Surveying. For Managers of Mines and Collieries. 8vo. 302 pages. Illustrated.....	2.50
BURR, W. H. Ancient and Modern Engineering, and the Isth- mian Canal. 8vo. 473 pages. Illustrated.....	3.75
CLARK, J. M. New System of laying out Railway Turnouts. 12mo.....	1.00

	PRICE
CLEEMAN, T. M. Railroad Engineers' Practice. Illustrated. 12mo.....	\$1.50
DAVIES, CHAS. Elements of Surveying and Leveling; Topography, Railway Curves, and Mining Surveying. 12mo.....	2.50
DORR, B. F. Surveyors' Guide and Pocket Table-Book. The Rules cover every case likely to occur in a surveyor's practice, and are based on United States laws, and have the approval of the Commissioner of the General Land Office.....	2.00
GILLESPIE'S SURVEYING. New edition in two parts. Part I. Land Surveying and Direct Leveling. 8vo. 551 pages. Illustrated.....	2.50
GILLESPIE'S SURVEYING. New edition. Part II. Higher Surveying. 467 pages. Illustrated.....	2.50
GILLESPIE, W. M. Principles and practice of Road-Making. 12mo.....	2.50
GILLMORE, GEN. Q. A. Construction of Roads, Streets and Pavements. 12mo. 258 pages. 70 illustrations.....	2.00
GOODHUE, W. F. Municipal Improvements. Methods, Utility and Cost of Public Improvements. 12mo. 207 pages. Illustrated.....	1.50
HAUPT, L. M. Engineering Specifications and Contracts. Text-book and Work of Reference. 8vo. Illustrated.....	3.00
HAUPT, L. M. The Topographer; his Instruments and Methods. Fully illustrated. 8vo.....	3.00
HODGMAN, F. Manual of Land Surveying. The Law is from the Statute Books of the United States and about 160 decisions from the highest courts in the land; the Practice is from the best authorities. 503 pages. 21 tables.....	2.50
JEFFERS, W. N. Treatise on Nautical Surveying. 8vo. Illustrated.....	5.00
JOHNSON, J. B. Engineering Contracts and Specifications. 452 pages. 8vo. Illustrated.....	3.00
JOHNSON, J. B. Theory and Practice of Land and Railroad Surveying, including Hydrography, Geodetic and Mining Surveying. 900 pages. Illustrated. 8vo.....	4.00
MAHAN, D. H. A Treatise on Civil Engineering. Revised by De Volson Wood. 8vo. 637 pages.....	5.00
MERRIMAN, M. Elements of Precise Surveying and Geodesy. 8vo. 261 pages. Illustrated.....	2.50
MCCULLOUGH, ERNEST. Engineering Work in Towns and Small Cities. 12mo. 483 pages.....	3.00
NUGENT, P. C. Plane Surveying, Text and Reference Book for Students and Engineers. 8vo. 577 pages. 320 illustrations..	3.50
PATTON, W. M. Treatise on Civil Engineering. 8vo. 1,654 pages. 468 illustrations. Half leather.....	7.50
PENCE, W. D., and KETCHUM, M. S. Surveying Manual of Field and Office Methods. 12mo. 250 pages. Illustrated..	2.00

	PRICE
PHELPS, LIEUT. H. Practical Marine Surveying. 8vo. 217 pages. Illustrated	\$2.50
PLANE-TABLE, and its use in Topographical Surveying. From the papers of U. S. Coast Survey. Illustrated. 8vo.....	2.00
RANKINE, W. J. M. Civil Engineering, comprising Engineering Surveys, Earthwork, Foundations, Masonry, Carpentry, Metal-Works, Loads, Railways, Canals, Rivers, Water-works, Harbors, etc., with tables and illustrations. 8vo. London.....	6.50
RAYMOND, W. G. Text-Book of Plane Surveying. 8vo. 485 pages. Illustrated.....	3.50
ROBINSON'S Surveying and Navigation. With use of instruments, essential Elements of Trigonometry, Mensuration, and the necessary Tables. Edited by Oren Root, A. M. 8vo....	2.25
ROOT, CAPT. E. A. Military Topography and Sketching. 8vo. 395 pages. 219 illustrations. New Edition, enlarged.....	2.75
SIMMS, F. W. Principles and Practice of Leveling. With Law's method of laying out Curves. 8vo. 215 pages.....	2.50
TRACY, J. C. Plane Surveying. A Text Book and Pocket Manual. 16mo. 792 pages. Illustrated.....	3.00
UNDERHILL, JAS. Mineral Land Surveying. For Deputy Mineral Surveyors and Students of Mining Engineering. 12mo. 218 pages. Illustrated	3.00
WELLINGTON, A. M. The Economic Theory of the Location of Railways. 980 pages. 313 engravings, 204 tables. 8vo..	5.00
WHINERY, S. Municipal Public Works. 8vo. 255 pages....	1.75
WILSON, H. M. Topographic Surveying, including Geographic, Exploratory and Military Mapping, Camping, Photography, etc. 8vo. 910 pages. 181 illustrations and 18 plates.....	3.50

TREATISE ON INSTRUMENTS, ETC.

	PRICE
BAKER, I. O. Engineers' Surveying Instruments. 400 pages. 86 illustrations. 12mo.....	\$3.00
COX, WM. Manual of the Polar Planimeter.....	.25
COX, WM. Slide-Rule Manual.....	.50
CROCKETT, C. W. Explanation of Mannheim Slide-Rule....	.75
GURLEY, W. & L. E. Manual of the Principal Instruments used in American Engineering and Surveying. Latest edition, revised. 470 pages. Fully illustrated.....	.50
HALSEY, F. A. Manual of the Slide-Rule.....	.50
HOARE, C. The Slide-Rule, and How to Use It. With a Slide- Rule in tuck of cover.....	1.00
MANUAL of the Duplex and Mannheim Slide-Rules.....	.75
STANLEY, W. F. Surveying and Leveling-Instruments. Fully described. 12mo. 552 pages. 345 illustrations.....	3.00
WHEATLEY, J. Y. Polar Planimeter. Its Use in Engineering Calculations. 8vo. 126 pages. Illustrated.....	3.00

MISCELLANEOUS

ALEXANDER, J. H. Weights and Measures. Ancient and Modern, reduced to Standard of the United States. 8vo.....	\$3.50
BENJAMIN, PARK. Engineers' and Mechanics' Recipes. 12mo. 300 pages.....	2.00
CHAUVENET, W. Plane and Spherical Trigonometry. 8vo...	1.60
CHAUVENET, W. Treatise on Elementary Geometry. 8vo...	1.75
CLARKE, D. K. Fuel; its Combustion and Economy. 12mo..	1.50
CROCKETT, C. W. Elements of Plane and Spherical Trigonom- etry, with Tables.....	1.50
DAVIES, C. Analytical Geometry and Elements of Calculus. 8vo. In one vol.....	2.25
DAVIES, C. Metric System.....	1.00
LIPPINCOTT'S Pronouncing Gazetteer of the World. 4to, sheep..	12.00
ROBINSON'S Geometry and Trigonometry. 8vo.....	2.25
WEBSTER'S Unabridged Dictionary. 4to, sheep.....	12.00

SCIENCE SERIES

18 MO. FANCY BOARDS, 50 CENTS EACH

No.

- 1 Chimneys for Furnaces, Fire Places, and Steam Boilers. By R. Armstrong, C. E.
- 4 Proportion of Pins Used in Bridges. By Chas. E. Bender, C. E.
- 5 Ventilation of Buildings. By W. F. Butler.
- 6 Designing and Construction of Reservoirs. By A. Jacob, A. B.
- 11 Theory of Arches. By Prof. W. Allan.
- 12 Theory of Voussoir Arches. By Prof. W. E. Cain.
- 13 Gases met with in Coal Mines. By J. J. Atkinson.
- 14 Friction of Air in Mines. By J. J. Atkinson.
- 15 Skew Arches. By Prof. E. W. Hyde.
- 17 Water and Water Supply. By Prof. W. H. Corfield.
- 18 Sewerage and Sewage Purification. By W. N. Baker, Ph. B.
- 19 Strength of Beams under Transverse Loads. By Prof. W. Allan.
- 20 Bridge and Tunnel Centers. By E. S. Gould, C. E.
- 22 High Masonry Dams. By John B. McMaster, C. E.
- 23 Fatigue of Metals under repeated Strains. From the German of Prof. Spangenburg, with a Preface by S. H. Shreve, A. M.
- 25 Theory and Calculation of Continuous Bridges. By M. Merriman, Ph. D.
- 26 Practical Treatise on Continuous Bridges. By Charles Bender, C. E.
- 31 Sanitary Condition of Dwelling Houses. By Geo. E. Waring, Jr.
- 32 Cable Making of Suspension Bridge. By Hildenbrand, C. E.
- 33 Mechanics of Ventilation. By Geo. W. Rafter, C. E.
- 34 Foundations. By Prof. Jules Gaudard, C. E.
- 35 Aneroid Barometer: Its Construction and Use. By Geo. W. Plympton.
- 38 Maximum Stresses in Frame Bridges. By Prof. W. E. Cain, A. M.
- 40 Transmission of Power by Compressed Air. By R. Zahner, M. E.
- 41 Strength of Materials. By Wm. Kent, C. E.
- 42 Voussoir Arches Applied to Stone Bridges, Tunnels, Culverts, Groined Arches, and Domes. By Prof. W. E. Cain, C. E.
- 44 Turbine Wheels. By Prof. W. P. Trowbridge.
- 48 Theory of Solid and Braced Arches. By W. E. Cain, C. E.
- 50 Dwelling Houses; their Sanitary Construction and Arrangements. By Prof. W. H. Corfield.
- 55 Sewer Gases; their Nature and Origin. By A. de Varona.
- 56 Actual Lateral Pressure of Earthwork. By Benj. Baker, C. E.
- 58 Ventilation of Coal Mines. By W. Fairley.

- No.
- 59 Railroad Economics. By S. W. Robinson, C. E.
- 60 Strength of Wrought Iron Bridge Members. By S. W. Robinson, C. E.
- 61 Potable Water: and Methods of Detecting Impurities. By Chas. W. Folkard.
- 63 House Drainage and Sanitary Plumbing. By W. P. Gerhard, C. E.
- 65 Pocket Logarithms to Four Places of Decimals.
- 67 Hydraulic Tables. By P. J. Flynn, C. E.
- 72 Topographical Surveying. By Geo. J. Specht, Prof. A. S. Hardy, John B. McMaster and H. F. Walling.
- 74 Testing Machines, their History, Construction and Use. By Arthur V. Abbott.
- 77 Stadia Surveying and Stadia Measurements. By A. Winslow.
- 80 Healthy Foundations for Houses. By Glenn Brown.
- 81 Water Meters: Comparative Tests of Accuracy, Delivery, etc. By Ross E. Browne.
- 82 Preservation of Timber by the Use of Antiseptics. By S. B. Boulton, C. E.
- 83 Mechanical Integrators. By Prof. Henry S. H. Shaw, C. E.
- 84 Flow of Water in Open Channels, Pipes, Conduits, Sewers, etc.; with Tables. By P. J. Flynn, C. E.
- 87 Treatise on the Theory of the Construction of Helicoidal Oblique Arches. By John L. Culley, C. E.
- 88 Beams and Girders. Formulas for their Resistance. By Prof. P. H. Philbrick.
- 91 Leveling; Barometric, Trigonometric, and Spirit. By Prof. I. O. Baker.
- 93 Notes Embodying Recent Practice in the Sanitary Drainage of Buildings. By Wm. Paul Gerhard, C. E.
- 94 Treatment of Sewage. By Dr. C. Meymott Tidy.
- 95 Plate Girder Construction. By Isami Hiroi, C. E.
- 100 How to Become an Engineer. By G. W. Plympton, C. E.
- 101 The Sextant and other Reflecting Mathematical Instruments. By F. R. Brainard, U. S. Navy.
- 104 Van Nostrand's Table Book for Civil and Mechanical Engineers. Compiled by Prof. Geo. W. Plympton.
- 107 Graphical Method for Swing-Bridges. By B. F. LaRue, C. E.
- 110 Transition Curves. By W. G. Fox.
- 114 Manual of the Slide-Rule. By F. A. Halsey.
- 115 Traverse Table, for distances between 1 and 100, and for every quarter degree up to 90 degrees.

Any of the Science Series not mentioned in the above list will be furnished promptly on application.

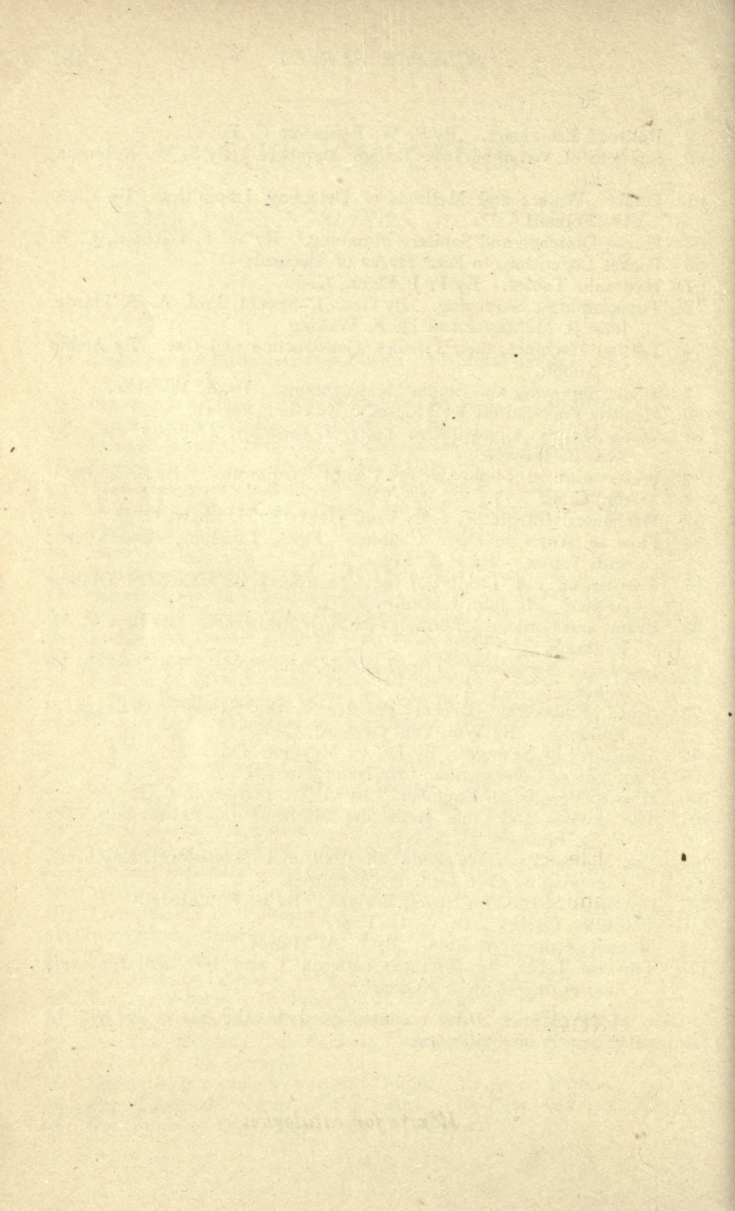

DEPARTMENT P

W. & L. E. GURLEY

TROY, N. Y., U. S. A.

MAKERS OF

Physical and Scientific Instruments

for Colleges, Schools, and Private Laboratories
also Special Apparatus according to specifications

Electrical Keys, Resistance Boxes, Optical
and Mechanical Laboratory Apparatus, Etc.

Standard Weights and Measures

Write for catalogues

THE RENSSELAER POLYTECHNIC INSTITUTE

TROY, N. Y.

A SCHOOL OF ENGINEERING AND SCIENCE

FOUNDED IN 1824

It is the aim of the Institute to maintain the most thorough course of engineering in this country. Its methods of instruction are the result of an experience unequaled by that of any similar school in the world. The Course of Study pursued, while not beyond the capacity of young men of average ability, is constantly adjusted to the progress of the engineering profession. Its purpose is to equip students to enter upon a general engineering practice and to specialize later as opportunities open before them. That the plan has been attended with unqualified success is shown by the Catalogue issued annually, containing the business address of every living graduate. Among them will be found men eminent in every branch of engineering. It is, moreover, the method of instruction pursued for other professions.

It should be stated, perhaps, that Civil Engineering is understood to include instruction in Road and Bridge Construction, Hydraulics, Steam and Electrical Engineering, Mining Engineering and Assaying.

The studies of the course are designed as a professional preparation, at once thorough and practical, for the following specialties of engineering practice :

The location, construction, and superintendence of public works, as steam and electric railways, canals, water works, etc.; the design, construction and management of mills, iron works, steel works, chemical works, and pneumatic works; the design and construction of roofs, arch bridges, girder bridges, and suspension bridges; the survey and superintendence of hydraulic motors, air engines, electric motors, and the various kinds of steam engines; the design, construction and use of machines in general, and the determination of their efficiency; the survey of rivers, lakes, and harbors, and the direction of their improvements; the determination of latitude, longitude, time, and the meridian in geographical explorations, or for other purposes, together with the projection of maps; the selection and test of materials used in construction; the construction of the various kinds of geometrical and topographical drawings.

A course of study is also pursued in the Institute embracing more advanced instruction in Natural History, Chemistry, and Geology, leading to the degree of Bachelor of Science. The first two years are identical with the course in Civil Engineering.

Special students in all courses, particularly in chemistry and electrical engineering, are also received.

There are two terms in the scholastic year and the tuition is \$100 per term. Other expenses are largely within the control of individual students. Every effort is made by the management to keep necessary expenses within the narrowest limits, consistent with the best opportunities to students, and they have been materially reduced within the last few years.

Any one desiring a thorough course of study in preparation for advanced professional work in any department of engineering is invited to apply for further information to the President of the Institute.

‘The greatest number of the renowned hydraulic and railroad engineers of America are graduates of this school.’—*From the report to his government of Professor A. Riedler of the Royal Polytechnicum, at Berlin. (Report U. S. Commissioner of Education, 1892-'93.)*

“This famous Institute is by no means local, as the freshman list this year contains the names of students from twenty-two States of the Union, as well as from Cuba and South America, and the graduates are leading men in engineering and in business all over the world.”—*The Railroad Gazette, February 22, 1901.*

ROADS,

RAILROADS,

BRIDGES,

ARCHES,

DAMS.

STEAM ENGINES,

ELECTRIC ENGINES,

DYNAMOS,

TURBINES.

FOUNDATIONS,

WATER WORKS,

TUNNELS,

SEWERS,

RIVERS,

CANALS.

CHEMICAL ANALYSIS,

MINERALOGY,

METALLURGY,

ASSAYING.

TABLE OF CONTENTS

	PAGE
Abney Level and Clinometer	244, 291
Acoustic Current Meter	231, 291
Adjustment of Architects' Level	179
Adjustment of Drainage Level	183
Adjustment of Engineers' and Surveyors' Transits	21-26
Adjustment of Engineers' Y Level	169-174
Adjustment of Line of Collimation	22, 138, 171
Adjustment of Objective Slide	25, 169
Adjustment of Solar Attachment	93-95
Adjustment of Solar Compasses	108, 144
Adjustment of Surveyors' Compasses	124
Adjustment of Telescopic Sight	137
Air Meters	424-426
Alidades for Plane-Tables	212-214, 216, 289
Alt-Azimuth	413
Alteneder Drawing-Instruments	318-322
Aluminum Instruments	160, 257, 279
Anemometers	424-426
Aneroid Barometers	420-423
Angle Mirrors	416
Architects' Levels	177-181, 280
Artificial Horizon	416
Astronomical Telescopes	431
Astronomical Terms	97-102
Attachments and Extras for Compasses	133, 137, 152, 276, 277
Attachments and Extras for Transits	54-77, 274, 275
Ball-Spindle	120, 131, 264, 276
Barometers, Aneroid	420-423
Batson Sketching-Case	217, 290
Battery for Current Meters	228, 290
Beaman Stadia Arc	62, 274
Binocular Hand Level	241, 242, 291
Blowpipes	437
Blue-print Paper, Print Frames and Bath Trays	383-385
Books, Blank, for Field Notes	392-394
Books, Scientific, for Architects, Draftsmen, Engineers and Surveyors	441-457
Boxes and Cases for Compasses, Levels and Transits	264, 265, 282
Boxes and Cases for Drawing-Instruments	310, 323
Boxwood Rules and Scales	352-359
Boyden Hook-Gauge	239, 290
Bristol Board	380

	PAGE
Bronze Finish.....	257
Brushes for Water-Colors.....	406, 407
Builders' Transit.....	50, 274
Celluloid or Amber Goods.....	347, 348, 363, 364, 366, 370, 372, 376
Center-Pin.....	128
Chains, American.....	245-247, 292
Chains, Metric and Vara.....	248, 293
Chain Tapes.....	249, 294
Clamp and Tangent.....	13, 59, 61, 137, 274, 277, 278
Clinometers.....	155, 243, 279, 412, 413, 419
Colors, Winsor & Newton's.....	401, 403-405
Compass Attachments for Levels.....	165, 183, 280
Compasses, Clinometer.....	155, 279
Compasses, Dial.....	158-160, 279
Compasses, Extras for.....	133, 137, 152, 276, 277
Compasses, Geologists'.....	153, 279
Compasses, Miners' Dip-Needle.....	156, 279
Compasses, Plain.....	130, 152, 276, 278
Compasses, Pocket.....	142-160, 277-279, 410-414
Compasses, Prismatic.....	413, 414
Compasses, Railroad.....	112, 145, 276-278
Compasses, Solar.....	106, 142, 275, 277
Compasses, Vernier.....	117, 149, 276, 278
Compound Tangent Ball-Spindle.....	131, 276
Crayon Pencils and Lumber Crayons.....	395, 396
Cross-Section Books and Paper.....	386, 389, 390, 394
Cross-Staff Heads.....	416
Cross-Wires.....	8, 24, 262, 263, 264, 265
Current Meter Reduction Tables.....	229, 232, 236
Current Meters.....	223-238, 290
Curves of Amber, Rubber and Wood.....	376, 377
Declination Arc.....	70, 94, 143
Declination of Magnetic Needle.....	121-123
Declination of the Sun.....	73, 83, 84, 98
Detachable Telescopes for Transits.....	66, 275
Diagonal Prism for Eyepiece of Telescopes.....	67, 275
Dial Compasses.....	158-160, 279
Dip-Needle Compasses.....	156, 279
Diurnal Variation.....	123
Drainage Levels.....	182, 280
Drawing-Boards and Tables.....	367, 368
Drawing-Instruments, Alteneder.....	318-322
Drawing-Instruments, Brass.....	338-342
Drawing-Instruments, German.....	324-342

	PAGE
Drawing-Instruments, Nickel-plated	310-342
Drawing-Instruments, Pivot-joint	315-323
Drawing-Instruments, Swiss	302-317, 343-345
Drawing-Paper	380-383, 387-390
Dust Guard for Objective Slide of Telescope	11, 162, 267, 275
Electric Current Meter	233-238, 290
Electricity	126
Electric Register	224, 228, 290
Ellipses	376
Empty Cases for Instruments	264, 265, 282, 310, 323
Engineers' Levels	162, 280
Engineers' Transits	6, 28-31, 270, 271
Erasing-Knives and Erasing-Rubber	397-399
Excavation and Embankment Tables	394, 451, 452
Explorers' Transit	32-34, 271
Extras for Compasses	133, 137, 152, 276, 277
Extras for Transits	54-77, 274, 275
Eyepiece for Transit and Level Telescope	5, 7, 264, 265
Eyepiece of Telescope, how composed	5-7
Field-Glasses and Telescopes for Tourists	427-430
Flagstaff or Ranging-Pole	203, 285, 286
Foreign Shipment	258, 259
Geologists' Compass	153, 279
Gradienter	64, 274
Graduations of Limb and Vertical Circle	14-18, 19, 262, 266, 275
Hand Levels	241-244, 291
Hook-Gauge, Boyden's	239, 240
Hour Circle and Hour Arc	70, 95, 144, 159, 279
Hydrometers	440
Hygrometer	438
Hyperbolas	376
India Ink	401, 402
Information to Purchasers	253
Ink for Drawing or Writing	383, 401, 402
Ink-Slabs and Color-Saucers	407, 408
Inverting Eyepiece	7
Ivory Rules and Scales	351-353, 359
Lacquering	257
Latitude Arc	70, 91, 92, 143, 275
Latitude Level	90, 275
Leather Cases and Pouches	190, 282

	PAGE
Leveling-Adopter	131, 152, 276, 278
Leveling-Instruments, Architects'	177-181, 280
Leveling-Instruments, Drainage	182-184, 280
Leveling-Instruments, Y Levels	162, 177, 280
Leveling-Rods	191-203, 283-286
Leveling Tripod Head	19, 132, 169, 267, 275, 276, 278
Level on Telescope	59, 137, 274, 277
Level-Vials and Spirit-Levels ...	13, 22, 117, 124, 128, 167, 172, 435, 436
Limbs of Transits	14-18, 266
Line of Collimation	22-24, 138, 171
Locke Level	243, 291
Magnetic Needle	12, 74, 110, 115, 121, 124, 127
Magnets	437
Magnifiers	61, 275, 432-434
Magnifying Power of Telescope	7, 8
Marking-Pins and Timber-Scribe	249, 293
Meters, Current	223-238, 290
Metric Aneroid Barometers	421
Metric Chains and Tapes	248, 251, 292, 298
Metric Leveling-Rods and Poles	201, 203, 284, 285, 286
Metric Paper for Draftsmen	388, 390
Metric Rules and Scales	357, 362
Miners' Dip-Needle Compasses	156, 279
Miners' Lamps and Water Gauge	440
Miscellaneous	265, 455
Monocular Hand Level	241, 242, 291
Mountain Transits	35, 271
Mucilage	400
Objective of Telescopes	5, 264, 265
Odometers	418
Offset Standard	134, 277
Oilstones	436
Opera and Field-Glasses	427, 428
Optical Axis	8, 134
Optical Principle of Telescope	5, 7
Outkeeper	119
Packing and Shipping	258, 260, 267
Pantographs	379
Paper Cutter	391
Paper, Drawing and Tracing	380-383, 386-390
Parabolas	376
Parallel Rulers	378, 379
Parchment Paper	382, 383

	PAGE
Parts of Instruments liable to injury, Prices of.....	264, 265
Passometers	417
Payment, Terms of	255, 263
Pedometers	417
Pencils.....	395
Pencil-Sharpener	397
Pens, Mapping and Writing	396
Plain Compasses	130, 152, 276, 278
Plane-Tables.....	205, 287-289
Planimeters.....	310, 311
Platinum Cross-Wires.....	8, 24, 262, 263, 264, 265
Plummet Lamp.....	68, 275
Plummets	265, 281
Pocket Compasses.....	142-160, 277-279, 410-414
Pocket Levels.....	435
Polar Axis.....	94
Price List.....	264-457
Prismatic Compasses.....	413, 414
Profile-Books and Paper.....	387, 388, 392
Protractors of Boxwood, Brass, Celluloid, German Silver, Horn, Ivory, Paper, Rubber and Wood.....	343-352
Protractors, Limb, long steel blade.....	345, 346
Quick-Leveling Attachment.....	275
Rack and Pinion.....	5, 166, 266, 275, 278
Railroad Compasses.....	112, 145-148, 276-278
Rain Gauge and Water Gauge.....	439
Ranging-Poles	203, 286
Reading-Glasses and Magnifiers.....	432-434
Reconnaissance Transit.....	48, 273
Reflecting Mirrors and Prisms.....	416
Reflectors for Cross-Wires and Limb of Transits.....	19, 67, 267, 275
Refraction.....	77, 102
Refractions, Table of.....	78-82
Rensselaer Polytechnic Institute.....	459
Repairs to Instruments.....	260-263
Rod Level.....	204, 286
Rods, Leveling.....	191-202, 283-286
Rubber Goods.....	363-365, 370, 372, 375-378, 397-399
Scales of Boxwood, Ivory, Paper and Metal.....	351-361
Section-Liners	373, 374
Selection of Instruments.....	253
Sextants.....	415
Shifting Center for Leveling-Head of Transits.....	20, 266

	PAGE
Short Focus.....	11, 162, 266
Sights on Standards and on Telescope of Transits.....	61, 275
Sizes of Compasses.....	113, 116, 120, 130, 149, 152
Sizes of Levels.....	177
Sizes of Transits.....	28, 32, 42, 45, 48, 53
Sketch Blocks, Paper.....	386
Sketching-Case, Batson.....	217, 290
Slide-Rules.....	358, 361
Slope-Levels.....	419
Sockets of Levels.....	164, 168
Sockets of Transits.....	18, 19, 28, 35, 41, 43, 45
Solar Attachment for Transits.....	30, 37, 46, 69-77, 275
Solar Compasses.....	106, 142, 275, 277
Solar Screen.....	89, 275
Solar Transits.....	30, 37, 46, 271-273
Special Notice.....	266
Spirit-Levels.....	13, 22, 118, 124, 128, 167, 264, 265, 435
Spring-Balance for Chains and Tapes.....	291
Stadia Arc.....	62, 274
Stadia Rods.....	199, 283
Stadia Wires.....	9-11, 262, 263, 267, 275
Staff Mountings.....	120, 264
Steel Rules.....	362
Steel Tapes.....	249-251, 294-299
Stencil Alphabets and Figures.....	408, 409
Straight-Edges of Amber, Rubber, Wood and Steel.....	362-364
Striding-Level.....	95, 275
Surveyors' Cross-Staff Head.....	416
Surveyors' Transits.....	39-47, 272, 273
Tables, Drawing.....	367, 368
Tables, Plane.....	205, 287-289
Tables, Reduction, for Current Meters.....	229, 232, 236
Tables, Traverse (books).....	451, 457
Tacks for Drawing-Boards.....	391
Tally Register.....	418
Tangent Scale on Sight Vanes.....	119
Tape Lines, Metallic.....	250, 295
Tape Lines, Steel.....	249-251, 294-299
Telescope, how composed.....	5-7, 162
Telescopes and Tourists' Glasses.....	427-431
Telescopes for Vertical Sighting.....	66, 275
Telescopic Sight Attachment.....	133-139, 277
Thermometers.....	437, 488
Timber-Scribe or Marking-Iron.....	293
Time-Recorder for Current Meters.....	227, 291
Tin Tubes for Drawing Paper.....	386

	PAGE
Tracing-Cloth and Paper.....	383
Trammel Points.....	436, 437
Transit-Instruments, General Description.....	5-26
Transits, Attachments for.....	54-77, 274, 275
Transits, Builders'.....	50, 274
Transits, Engineers'.....	6, 28, 270, 271
Transits, Explorers'.....	32, 271
Transits, Light Mountain and Mining.....	35, 271
Transits, Reconnoissance.....	48, 273
Transits, Solar.....	30, 37, 46, 271-273
Transits, Solar Attachment for.....	69-75, 275
Transits, Surveyors'.....	39-47, 272, 273
Transits, Vernier.....	52, 274
Transportation.....	259
Traverse Table Board and Tripod.....	215, 289
Traverse Tables (books).....	451, 457
Trial of Instruments.....	256
Triangles of Amber, German Silver, Rubber, Steel and Wood...	369-372
Tripods.....	20, 186-189, 207, 280, 281
T-Squares of Amber, Rubber, Steel and Wood.....	364-366
Vara Chains and Tape Lines.....	248, 251, 293, 298
Variation Arc of Transits.....	13, 267, 274
Variation of the Magnet Needle.....	115, 121-123
Vellum or Tracing-Cloth.....	383
Vernier Compasses.....	117-129, 149, 276, 278
Vernier Protractors.....	344-347
Verniers.....	18, 117, 121
Vernier Transit Compasses.....	52, 274
Vertical Arc and Vertical Circle.....	55-58, 137, 266, 274, 277
Warranty.....	255
Water-Colors.....	401, 403-405
Water-Glasses.....	407
Weights of Compasses.....	106, 113, 116, 121, 130, 144, 148, 150
Weights of Levels.....	177
Weights of Transits.....	28, 34, 38, 42, 45, 48, 51, 53
Ys of Leveling-Instruments.....	168, 173



UNIVERSITY OF CALIFORNIA LIBRARY

THIS BOOK IS DUE ON THE LAST DATE
STAMPED BELOW

OCT 8 1914

APR 25 1925

NOV 22 1926

FEB 1 1932
OCT 15 1927

OCT 31 1927

APR 19 1928

JAN 11 1929

24 Feb '58 JT

REC'D LD

FEB 10 1958

RECEIVED

JUL 9 '68-5 PM

LOAN DEPT.

YB 54658

Gurley

172837

TA581

G 8

1908

