

HISTORY INFORMATION FOR THE FOLLOWING MANUAL:

SERVICE MANUAL

BA-6 CHASSIS

<u>MODEL NAME</u>	<u>REMOTE COMMANDER</u>	<u>DESTINATION</u>	<u>CHASSIS NO.</u>
KV-20FS120	RM-Y194	US	SCC- S61K-A
KV-20FS120	RM-Y194	CND	SCC- S59H-A
KV-21FM120	RM-W151	LATIN NORTH	SCC- S60X-A
KV-21FS120	RM-Y194	LATIN NORTH	SCC- S60Y-A
KV-21FS120	RM-Y194	LATIN SOUTH	SCC- S73A-A
KV-21FA310	RM-Y180	LATIN NORTH	SCC- S60T-A
KV-21FA310	RM-Y180	LATIN SOUTH	SCC- S60U-A
KV-24FS120	RM-Y194	US	SCC- S61L-A
KV-24FS120	RM-Y194	CND	SCC- S59J-A
KV-25FS120	RM-Y194	LATIN NORTH	SCC- S73B-A
KV-25FS120	RM-Y194	LATIN SOUTH	SCC- S73C-A

ORIGINAL MANUAL ISSUE DATE: 3/2004

REVISION DATE

SUBJECT

3/2004

No revisions or updates are applicable at this time.

TRINITRON® COLOR TELEVISION
SONY®

9-965-959-01

SERVICE MANUAL

BA-6 CHASSIS

<u>MODEL NAME</u>	<u>REMOTE COMMANDER</u>	<u>DESTINATION</u>	<u>CHASSIS NO.</u>
KV-20FS120	RM-Y194	US	SCC- S61K-A
KV-20FS120	RM-Y194	CND	SCC- S59H-A
KV-21FM120	RM-W151	LATIN NORTH	SCC- S60X-A
KV-21FS120	RM-Y194	LATIN NORTH	SCC- S60Y-A
KV-21FS120	RM-Y194	LATIN SOUTH	SCC- S73A-A
KV-21FA310	RM-Y180	LATIN NORTH	SCC- S60T-A
KV-21FA310	RM-Y180	LATIN SOUTH	SCC- S60U-A
KV-24FS120	RM-Y194	US	SCC- S61L-A
KV-24FS120	RM-Y194	CND	SCC- S59J-A
KV-25FS120	RM-Y194	LATIN NORTH	SCC- S73B-A
KV-25FS120	RM-Y194	LATIN SOUTH	SCC- S73C-A



KV-24FS120



KV-21FA310

TRINITRON® COLOR TELEVISION
SONY®

TABLE OF CONTENTS

SECTION TITLE	PAGE
Specifications	4
Warnings and Cautions	6
Safety Check-Out	7
Self-Diagnostic Function.....	8
SECTION 1: DISASSEMBLY.....	10
1-1. Rear Cover Removal (All Except KV-21FA310).....	10
1-2. Rear Cover Removal (KV-21FA310 Only).....	10
1-3. Chassis Assembly Removal.....	11
1-4. Service Position	11
1-5. Picture Tube Removal.....	12
Anode Cap Removal Procedure.....	12
SECTION 2: SET-UP ADJUSTMENTS.....	13
2-1. Beam Landing	13
2-2. Convergence.....	14
2-3. Focus	15
2-4. Screen (G2).....	16
2-5. Method of Setting the Service Adjustment Mode	16
2-6. White Balance Adjustments	16
SECTION 3: SAFETY RELATED ADJUSTMENTS.....	17
3-1. <input checked="" type="checkbox"/> R565 Confirmation Method (HV Hold-Down Confirmation) and Readjustments	17
3-2. B+ Voltage Confirmation and Adjustment	17
SECTION 4: CIRCUIT ADJUSTMENTS.....	19
4-1. Setting the Service Adjustment Mode	19
4-2. Memory Write Confirmation Method	19
4-3. Remote Adjustment Buttons and Indicators	19
4-4. Service Data Lists	20
4-5. ID Map Table	34
4-6. A Board Adjustments.....	34
SECTION 5: DIAGRAMS.....	37
5-1. Circuit Boards Location	37
5-2. Printed Wiring Board and Schematic Diagram Information.....	37
5-3. Block Diagram and Schematics	38
A Board Schematic Diagram	39
HB Board Schematic Diagram (All Except KV-21FA310).....	41
HR Board Schematic Diagram (KV-21FA310 Only).....	44
CV Board Schematic Diagram	45
K Board Schematic Diagram (KV-21FA310 Only).....	49
5-4. Semiconductors	51
SECTION 6: EXPLODED VIEWS.....	52
6-1. Picture Tube (KV-20FS120/21FS120 Only)	52
6-2. Chassis (KV-20FS120/21FS120 Only).....	53
6-3. Picture Tube (KV-21FM120 Only)	54
6-4. Chassis (KV-21FM120 Only).....	55
6-5. Picture Tube (KV-21FA310 Only)	56
6-6. Chassis (KV-21FA310 Only)	57
6-7. Picture Tube (KV-24FS120/25FS120 Only)	58
6-8. Chassis (KV-24FS120/25FS120 Only).....	59
SECTION 7: ELECTRICAL PARTS LIST.....	60

SPECIFICATIONS

	KV-20FS120	KV-21FM120	KV-21FS120 (N)	KV-21FS120 (S)
Power Requirements	120V, 60Hz	120V, 60Hz	120V, 60Hz	220V, 50/60Hz
Number of Inputs/Outputs				
Video ¹⁾	2	2	2	2
S Video ²⁾	0	0	0	0
Y, P_B, P_R ³⁾	1	0	1	1
Audio ⁴⁾	4	2	4	4
Audio Out ⁵⁾	0	0	0	0
Speaker Output (W)	10W x 2	5W x 2	10W x 2	10W x 2
Headphones	1	1	1	1
Power Consumption (W)				
In Use (Max)	140W	125W	140W	135W
In Standby (Max) ⁶⁾	1W	1W	1W	1W
Dimensions (W x H x D)				
mm	631 x 468 x 490.5 mm	631 x 468 x 490.5 mm	631 x 468 x 490.5 mm	631 x 468 x 490.5 mm
in	24 ^{7/8} x 18 ^{3/8} x 19 ^{1/4} in	24 ^{7/8} x 18 ^{3/8} x 19 ^{1/4} in	24 ^{7/8} x 18 ^{3/8} x 19 ^{1/4} in	24 ^{7/8} x 18 ^{3/8} x 19 ^{1/4} in
Mass				
kg	25.2 kg	25.2 kg	25.2 kg	25.2 kg
lbs	55 lbs 9 oz	55 lbs 9 oz	55 lbs 9 oz	55 lbs 9 oz

	KV-21FA310 (N)	KV-21FA310 (S)	KV-24FS120 KV-25FS10 (N)	KV-25FS120 (S)
Power Requirements	120V, 60Hz	220V, 50/60Hz	120V, 60Hz	220V, 50/60Hz
Number of Inputs/Outputs				
Video ¹⁾	2	2	2	2
S Video ²⁾	1	1	1	1
Y, P_B, P_R ³⁾	1	1	1	1
Audio ⁴⁾	4	4	4	4
Audio Out ⁵⁾	1	1	1	1
Speaker Output (W)	5W x 3	5W x 3	10W x 2	10W x 2
Subwoofer	15W	15W	NA	NA
Headphones	1	1	1	1
Power Consumption (W)				
In Use (Max)	155W	150W	165W	160W
In Standby (Max) ⁶⁾	1W	1W	1W	1W
Dimensions (W x H x D)				
mm	609 x 540 x 503 mm	609 x 540 x 503 mm	718 x 526.5 x 480 mm	718 x 526.5 x 480 mm
in	24 x 21 ^{1/4} x 19 ^{3/4} in	24 x 21 ^{1/4} x 19 ^{3/4} in	28 ^{1/4} x 20 ^{3/4} x 18 ^{7/8} in	28 ^{1/4} x 20 ^{3/4} x 18 ^{7/8} in
Mass				
kg	28.6 kg	28.6 kg	32.8 kg	32.8 kg
lbs	63 lbs	63 lbs	72 lbs 5 oz	72 lbs 5 oz

- 1) 1 Vp-p 75 ohms unbalanced, sync negative
- 2) Y: 1 Vp-p 75 ohms unbalanced, sync negative
C: 0.286 Vp-p (Burst signal), 75 ohms
- 3) Y: 1.0 Vp-p, 75 ohms unbalanced, sync negative;
P_B: 0.7 Vp-p, 75 ohms
P_R: 0.7 Vp-p, 75 ohms
- 4) 500 mVrms (100% modulation), Impedance: 47 kilohms
- 5) More than 408 mVrms at the maximum volume setting (variable)
More than 408 mVrms (fix); Impedance (output): 2 kilohms
- 6) This specification is maximum wattage.

Television system

American TV standard, NTSC

Channel coverage

VHF: 2-13/ UHF: 14-69/ CATV: 1-125

Picture tube

FD Trinitron® tube

Visible screen size

20-inch picture measured diagonally
(KV-20FS120/21FM120/21FS120/21FA310 Only)

24-inch picture measured diagonally
(KV-24FS120/25FS120 Only)

Actual screen size

21-inch measured diagonally
(KV-20FS120/21FM120/21FS120/21FA310 Only)

25-inch measured diagonally
(KV-24FS120/25FS120 Only)

Antenna

75 ohm external terminal for VHF/UHF

Supplied Accessories

Remote Commander RM-Y194
(KV-20FS120/21FS120/24FS120/25FS120 Only)

Remote Commander RM-W151
(KV-21FM120 Only)

Remote Commander RM-Y180
(KV-21FA310 Only)

Two Size AA (R6) Batteries

Antenna, Telescopic
(KV-21FM120/21FS120/21FA310/25FS120 Only)

TruSurround™ by SRS (●)®

TruSurround is a trademark of SRS Labs, Inc. SRS and the SRS symbol are registered trademarks of SRS Labs, Inc. in the United States and in select foreign countries. SRS and TruSurround are incorporated under license from SRS Labs, Inc. and are protected under United States Patent Nos. 4,748,669 and 4,841,572 with numerous additional issued and pending foreign patents. Purchase of this product does not convey the right to sell recordings made with the TruSurround technology.

● SRS (SOUND RETRIEVAL SYSTEM)

The ● SRS (SOUND RETRIEVAL SYSTEM) is manufactured by Sony Corporation under license from SRS Labs, Inc. It is covered by U.S. Patent No. 4,748,669. Other U.S. and foreign patents pending.

The word 'SRS' and the SRS symbol ● are registered trademarks of SRS Labs, Inc. BBE and BBE symbol are trademarks of BBE Sound, Inc. and are licensed by BBE Sound, Inc. under U.S. Patent No. 4,638,258 and 4,482,866.

© 2004 Dolby Laboratories, Inc.
Dolby, Pro Logic, and the double-D symbol are registered trademarks of Dolby Laboratories.

Design and specifications are subject to change without notice.

WARNINGS AND CAUTIONS

CAUTION

Short circuit the anode of the picture tube and the anode cap to the metal chassis, CRT shield, or carbon painted on the CRT, after removing the anode.

WARNING!!

An isolation transformer should be used during any service to avoid possible shock hazard, because of live chassis. The chassis of this receiver is directly connected to the ac power line.

SAFETY-RELATED COMPONENT WARNING!!

Components identified by shading and  mark on the schematic diagrams, exploded views, and in the parts list are critical for safe operation. Replace these components with Sony parts whose part numbers appear as shown in this manual or in supplements published by Sony. Circuit adjustments that are critical for safe operation are identified in this manual. Follow these procedures whenever critical components are replaced or improper operation is suspected.

ATTENTION!!

Après avoir déconnecté le cap de l'anode, court-circuiter l'anode du tube cathodique et celui de l'anode du cap au châssis métallique de l'appareil, ou la couche de carbone peinte sur le tube cathodique ou au blindage du tube cathodique.

Afin d'éviter tout risque d'électrocution provenant d'un châssis sous tension, un transformateur d'isolement doit être utilisé lors de tout dépannage. Le châssis de ce récepteur est directement raccordé à l'alimentation du secteur.

ATTENTION AUX COMPOSANTS RELATIFS A LA SECURITE!!

Les composants identifiés par une trame et par une marque  sur les schémas de principe, les vues explosées et les listes de pièces sont d'une importance critique pour la sécurité du fonctionnement. Ne les remplacer que par des composants Sony dont le numéro de pièce est indiqué dans le présent manuel ou dans des suppléments publiés par Sony. Les réglages de circuit dont l'importance est critique pour la sécurité du fonctionnement sont identifiés dans le présent manuel. Suivre ces procédures lors de chaque remplacement de composants critiques, ou lorsqu'un mauvais fonctionnement suspecte.

SAFETY CHECK-OUT

After correcting the original service problem, perform the following safety checks before releasing the set to the customer:

1. Check the area of your repair for unsoldered or poorly soldered connections. Check the entire board surface for solder splashes and bridges.
2. Check the interboard wiring to ensure that no wires are "pinched" or touching high-wattage resistors.
3. Check that all control knobs, shields, covers, ground straps, and mounting hardware have been replaced. Be absolutely certain that you have replaced all the insulators.
4. Look for unauthorized replacement parts, particularly transistors, that were installed during a previous repair. Point them out to the customer and recommend their replacement.
5. Look for parts which, though functioning, show obvious signs of deterioration. Point them out to the customer and recommend their replacement.
6. Check the line cords for cracks and abrasion. Recommend the replacement of any such line cord to the customer.
7. Check the B+ and HV to see if they are specified values. Make sure your instruments are accurate; be suspicious of your HV meter if sets always have low HV.
8. Check the antenna terminals, metal trim, "metallized" knobs, screws, and all other exposed metal parts for AC leakage. Check leakage as described below.

Leakage Test

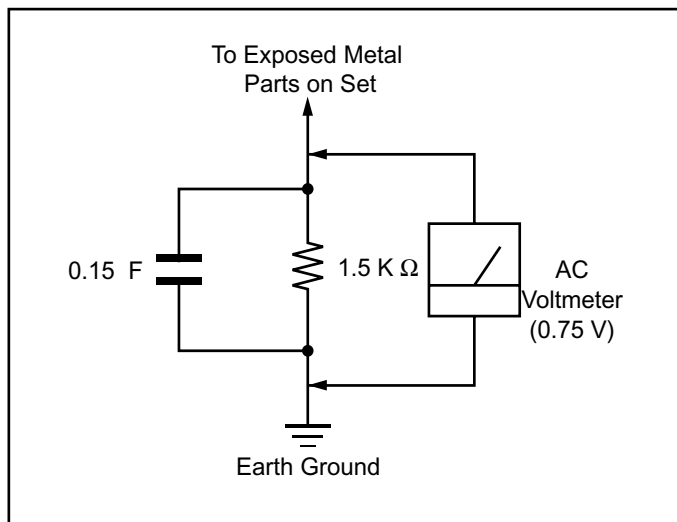

Figure A. Using an AC voltmeter to check AC leakage.

The AC leakage from any exposed metal part to earth ground and from all exposed metal parts to any exposed metal part having a return to chassis, must not exceed 0.5 mA (500 microamperes). Leakage current can be measured by any one of three methods.

1. A commercial leakage tester, such as the Simpson 229 or RCA WT-540A. Follow the manufacturers' instructions to use these instructions.
2. A battery-operated AC milliammeter. The Data Precision 245 digital multimeter is suitable for this job.
3. Measuring the voltage drop across a resistor by means of a VOM or battery-operated AC voltmeter. The "limit" indication is 0.75 V, so analog meters must have an accurate low voltage scale. The Simpson's 250 and Sanwa SH-63TRD are examples of passive VOMs that are suitable. Nearly all battery-operated digital multimeters that have a 2 VAC range are suitable (see Figure A).

How to Find a Good Earth Ground

A cold-water pipe is a guaranteed earth ground; the cover-plate retaining screw on most AC outlet boxes is also at earth ground. If the retaining screw is to be used as your earth ground, verify that it is at ground by measuring the resistance between it and a cold-water pipe with an ohmmeter. The reading should be zero ohms.

If a cold-water pipe is not accessible, connect a 60- to 100-watt trouble- light (not a neon lamp) between the hot side of the receptacle and the retaining screw. Try both slots, if necessary, to locate the hot side on the line; the lamp should light at normal brilliance if the screw is at ground potential (see Figure B).

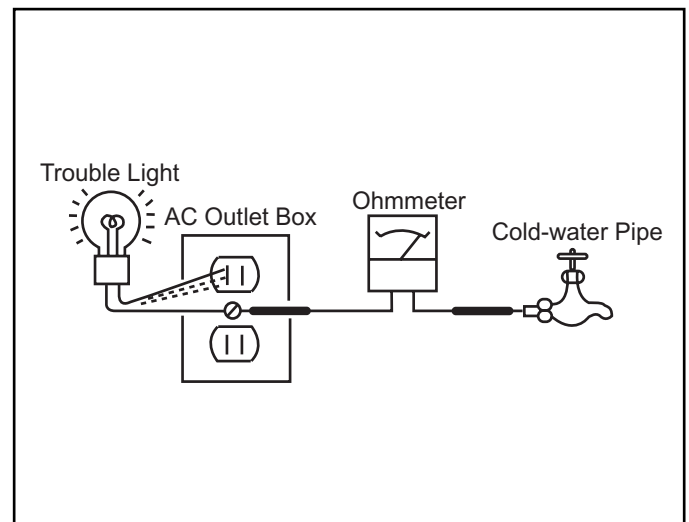

Figure B. Checking for earth ground.

SELF-DIAGNOSTIC FUNCTION



The units in this manual contain a self-diagnostic function. If an error occurs, the STANDBY/TIMER LED will automatically begin to flash. The number of times the LED flashes translates to a probable source of the problem. A definition of the STANDBY/TIMER LED flash indicators is listed in the instruction manual for the user's knowledge and reference. If an error symptom cannot be reproduced, the Remote Commander can be used to review the failure occurrence data stored in memory to reveal past problems and how often these problems occur.

Diagnostic Test Indicators

When an error occurs, the STANDBY/TIMER LED will flash a set number of times to indicate the possible cause of the problem. If there is more than one error, the LED will identify the first of the problem areas.

Results for all of the following diagnostic items are displayed on screen. No error has occurred if the screen displays a "0".

Diagnostic Item Description	No. of times STANDBY/ TIMER lamp flashes	Self-Diagnostic Display/ Diagnostic Result	Probable Cause Location	Detected Symptoms
Power does not turn on	Does not light	—————	<ul style="list-style-type: none"> Power cord is not plugged in. Fuse is burned out (F601). (A Board) 	<ul style="list-style-type: none"> Power does not come on. No power is supplied to the TV. AC Power supply is faulty.
+B overcurrent (OCP)*	2 times	2:0 or 2:1	<ul style="list-style-type: none"> H.OUT (Q506) is shorted. (A Board) (20"/21" models only) H.OUT (Q505) is shorted. (A Board) (24"/25" models only) •RGB Amp (IC1751) is shorted. (CV Board) 	<ul style="list-style-type: none"> Power does not come on. Load on power line is shorted.
I-Prot	4 times	4:0 or 4:1	<ul style="list-style-type: none"> +13V is not supplied. (A Board) IC545 is faulty. (A Board) 	<ul style="list-style-type: none"> Has entered standby state after horizontal raster. Vertical deflection pulse is stopped. Power line is shorted or power supply is stopped.
IK (AKB)	5 times	5:0 or 5:1	<ul style="list-style-type: none"> Video OUT (IC545) is faulty. (A Board) IC001 is faulty. (A Board) Screen (G2) is improperly adjusted.** 	<ul style="list-style-type: none"> No raster is generated. CRT Cathode current detection reference pulse output is small.

*If a +B overcurrent is detected, stoppage of the vertical deflection is detected simultaneously. The symptom that is diagnosed first by the microcontroller is displayed on the screen.

**Refer to Screen (G2) Adjustments in Section 2-4. of this manual.

Display of Standby/Timer LED Flash Count

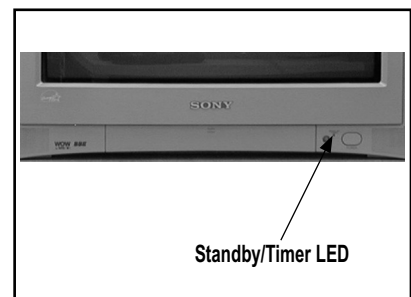
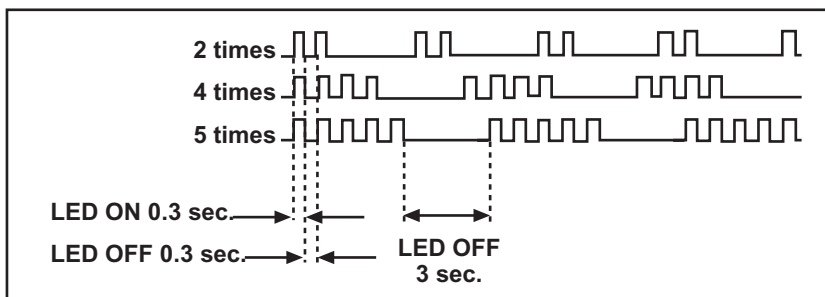

Diagnostic Item	Flash Count*
+B Overcurrent	2 times
I-Prot	4 times
IK (AKB)	5 times

*One flash count is not used for self-diagnostic.

Stopping the Standby/Timer LED Flash

Turn off the power switch on the TV main unit or unplug the power cord from the outlet to stop the STANDBY/TIMER LAMP from flashing.

Self-Diagnostic Screen Display

For errors with symptoms such as “power sometimes shuts off” or “screen sometimes goes out” that cannot be confirmed, it is possible to bring up past occurrences of failure on the screen for confirmation.

To Bring Up Screen Test

In standby mode, press buttons on the Remote Commander sequentially, in rapid succession, as shown below:

Display → Channel → Sound Volume → Power ON

↑ Note that this differs from entering the Service Mode (Sound Volume +).

Self-Diagnostic Screen Display

SELF DIAGNOSTIC		
2:	+B OCP	0
3:	+B OVP	N/A
4:	VSTOP	0
5:	AKB	1
101:	WDT	N/A

Numeral “0” means that no fault was detected.

Numeral “1” means a fault was detected one time only.

Handling of Self-Diagnostic Screen Display

Since the diagnostic results displayed on the screen are not automatically cleared, always check the self-diagnostic screen during repairs. When you have completed the repairs, clear the result display to “0”.

Unless the result display is cleared to “0”, the self-diagnostic function will not be able to detect subsequent faults after completion of the repairs.

Clearing the Result Display

To clear the result display to “0”, press buttons on the Remote Commander sequentially when the diagnostic screen is displayed, as shown below:

Channel → ENTER

Quitting the Self-Diagnostic Screen

To quit the entire self-diagnostic screen, turn off the power switch on the Remote Commander or the main unit.

Self-Diagnostic Circuit

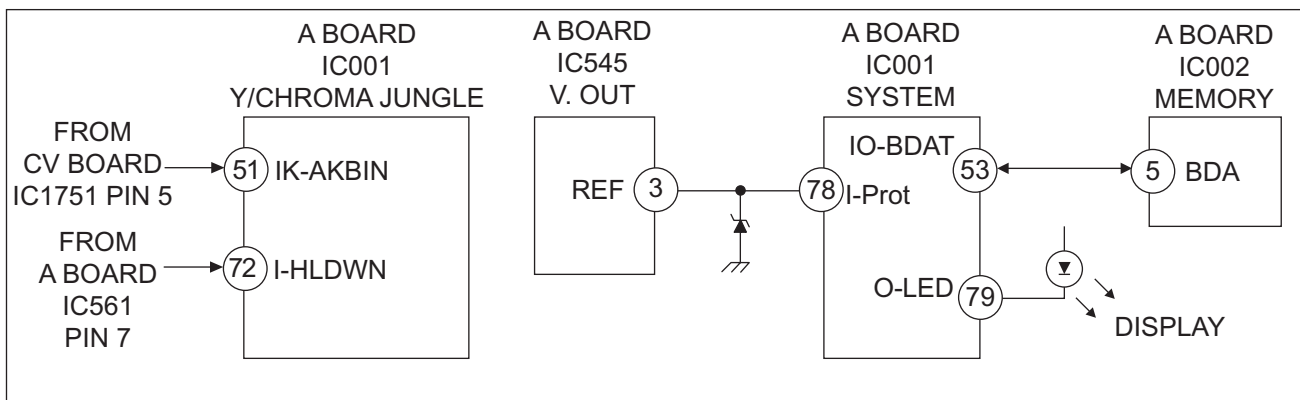

+B overcurrent (OCP)

Occurs when an overcurrent on the +B (135V) line is detected by pin 72 of IC001 (A Board). If the voltage of pin 72 of IC001 (A Board) is less than 1V when V.SYNC is more than seven verticals in a period, the unit will automatically turn off.

I-Prot

Occurs when an absence of the vertical deflection pulse is detected by pin 78 of IC001 (A Board). Power supply will shut down when waveform interval exceeds 2 seconds.

IK (AKB)

If the RGB levels* do not balance within 2 seconds after the power is turned on, this error will be detected by IC001 (A Board). TV will stay on, but there will be no picture.

*(Refers to the RGB levels of the AKB detection Ref pulse that detects 1K).

SECTION 1: DISASSEMBLY

1-1. REAR COVER REMOVAL (ALL EXCEPT KV-21FA310)

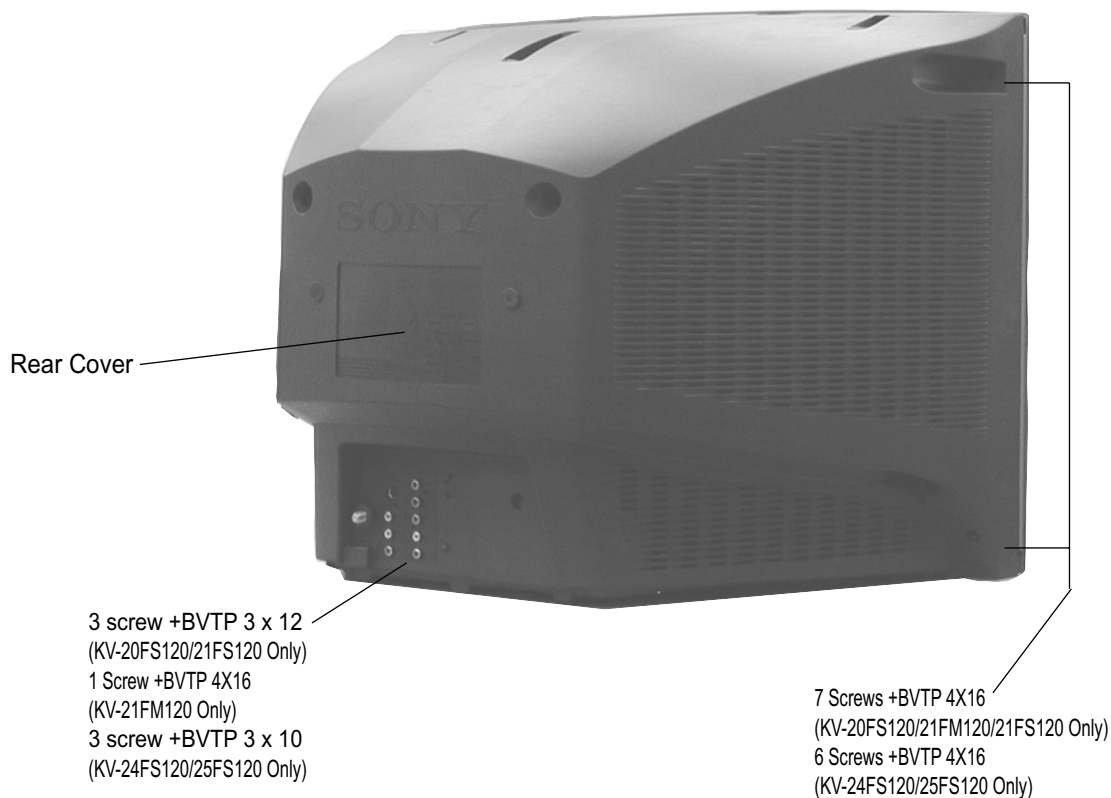

1-2. REAR COVER REMOVAL (KV-21FA310 ONLY)

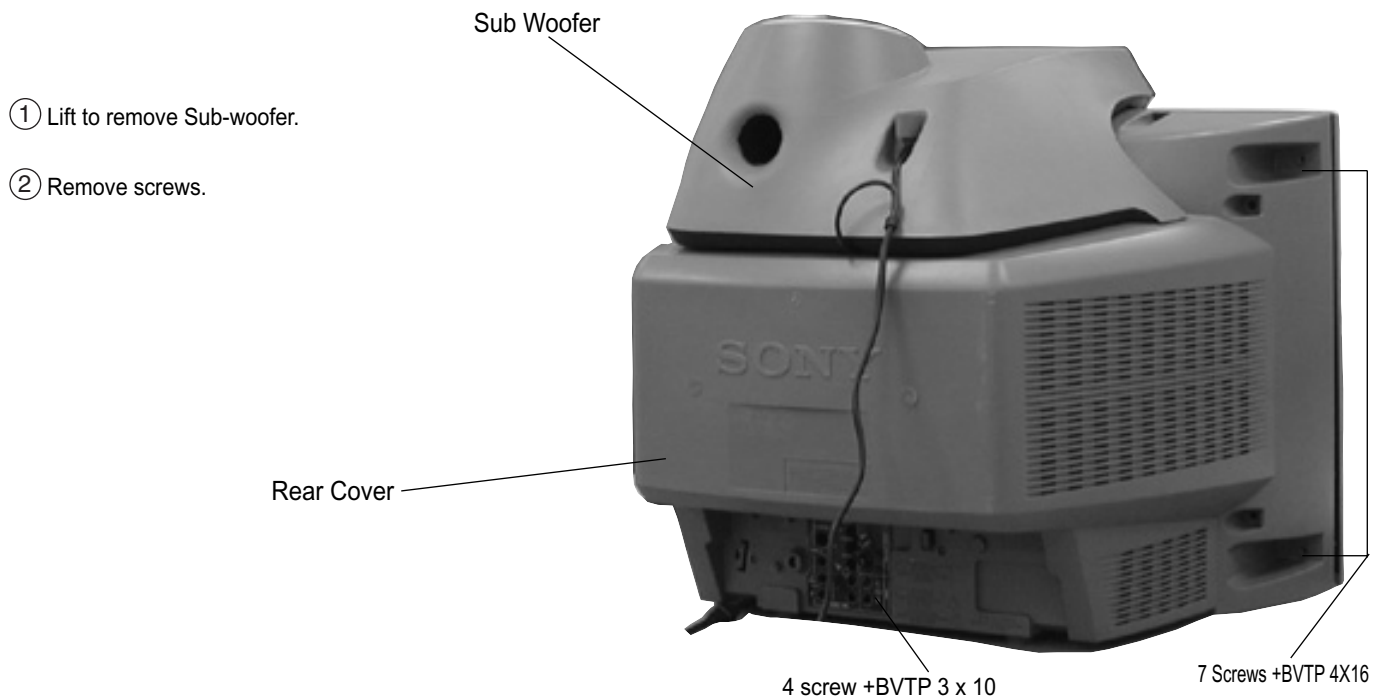

1-3. CHASSIS ASSEMBLY REMOVAL

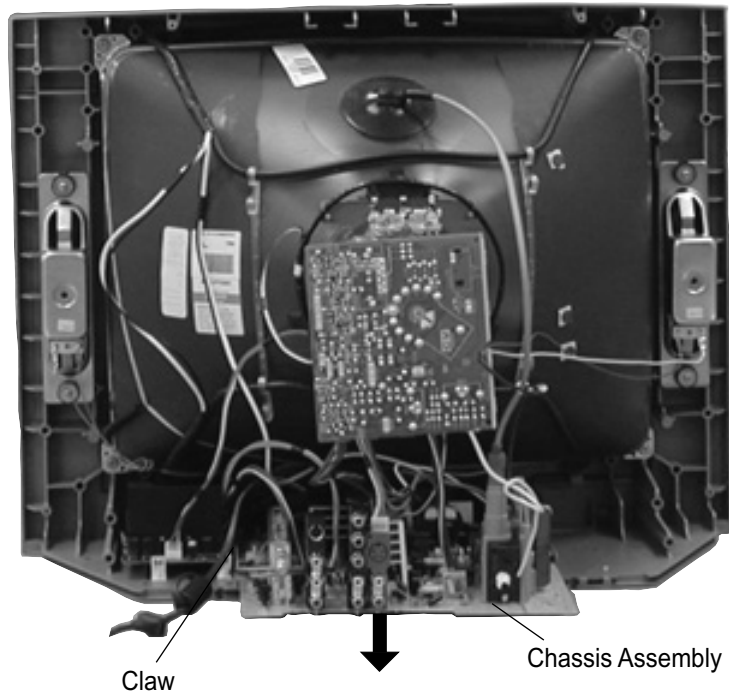

1-4. SERVICE POSITION

- ① Push down on clips to release K Board, then unplug the 2 pin woofer connector and move out of the way.
- ② Press on catch tab to release A Board.
- ③ Disconnect remaining cables to allow A Board to be removed.

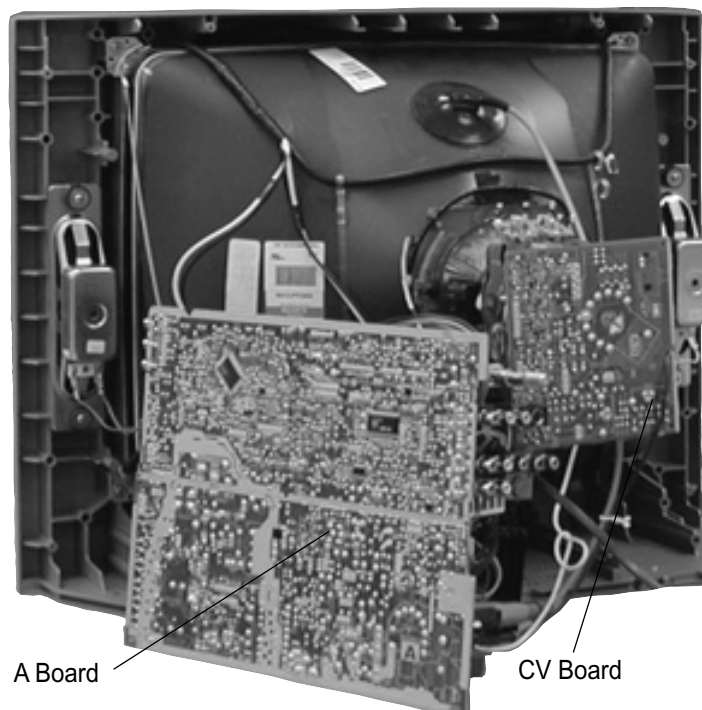

1-5. PICTURE TUBE REMOVAL

WARNING: BEFORE REMOVING THE ANODE CAP

High voltage remains in the CRT even after the power is disconnected. To avoid electric shock, discharge CRT before attempting to remove the anode cap. Short between anode and CRT coated earth ground strap.

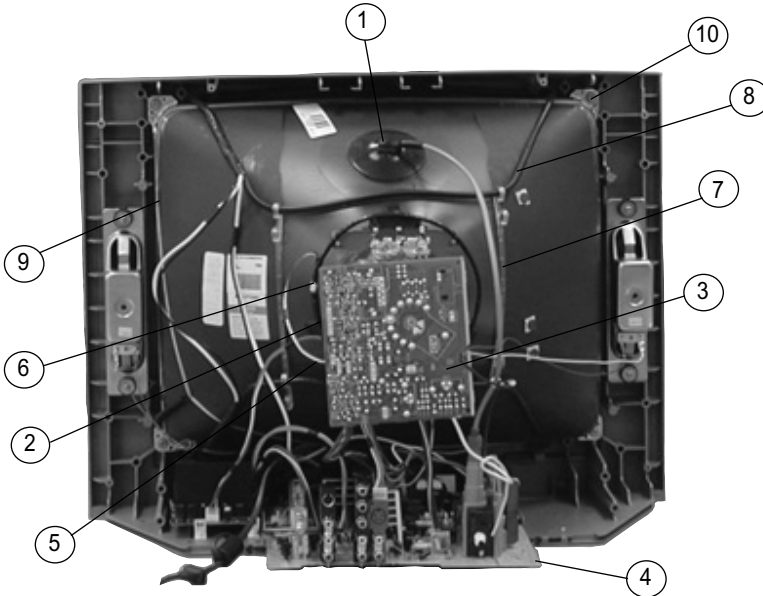
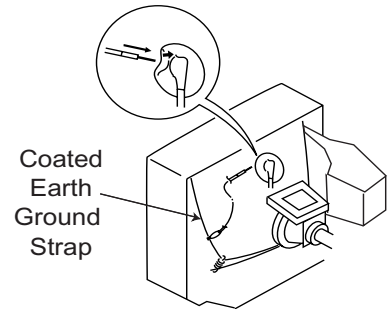

1. Discharge the anode of the CRT and remove the anode cap.
2. Unplug all interconnecting leads from the deflection yoke, neck assembly, degaussing coils and CRT grounding strap.
3. Remove the CV Board from the CRT.
4. Remove the chassis assembly.
5. Loosen the neck assembly fixing screw and remove.
6. Loosen the deflection yoke fixing screw and remove.
7. Place the set with the CRT face down on a cushion and remove the degaussing coil holders.
8. Remove the degaussing coils.
9. Remove the CRT grounding strap and spring tension devices.
10. Unscrew the four CRT fixing screws [located on each CRT corner] and remove the CRT [Take care not to handle the CRT by the neck].

ANODE CAP REMOVAL PROCEDURE

WARNING: High voltage remains in the CRT even after the power is disconnected. To avoid electric shock, discharge CRT **before** attempting to remove the anode cap. Short between anode and coated earth ground strap of CRT.

NOTE: After removing the anode cap, short circuit the anode of the picture tube and the anode cap to either the metal chassis, CRT shield, or carbon painted on the CRT.

REMOVAL PROCEDURES

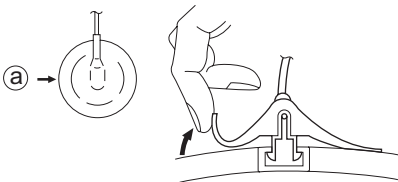

Turn up one side of the rubber cap in the direction indicated by arrow (a) .

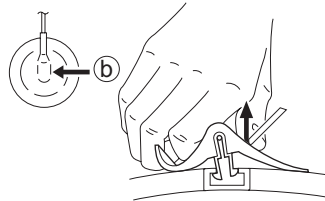

Use your thumb to pull the rubber cap firmly in the direction indicated by arrow (b) .

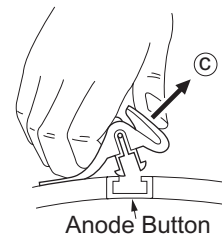

When one side of the rubber cap separates from the anode button, the anode cap can be removed by turning the rubber cap and pulling it in the direction of arrow (c) .

HOW TO HANDLE AN ANODE CAP

1. Do not use sharp objects which may cause damage to the surface of the anode cap.
2. To avoid damaging the anode cap, do not squeeze the rubber covering too hard. A material fitting called a shatter-hook terminal is built into the rubber.
3. Do not force turn the foot of the rubber cover. This may cause the shatter-hook terminal to protrude and damage the rubber.

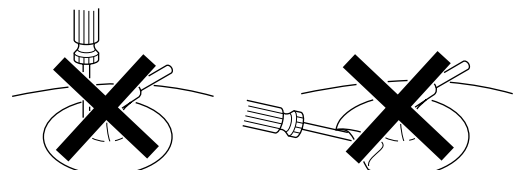

SECTION 2: SET-UP ADJUSTMENTS

The following adjustments should be made when a complete realignment is required or a new picture tube is installed.

These adjustments should be performed with rated power supply voltage unless otherwise noted.

Set the controls as follows unless otherwise noted:

VIDEO MODE: Pro

PICTURE CONTROL: Normal

BRIGHTNESS CONTROL: Normal

Perform the adjustments in order as follows:

1. Beam Landing
2. Convergence
3. Focus
4. Screen (G2)
5. White Balance

Note Test Equipment Required:

1. Color Bar Pattern Generator
2. Degausser
3. DC Power Supply
4. Digital Multimeter

2-1. BEAM LANDING

Before beginning adjustment procedure:

1. Degauss the entire screen.
2. Feed in the white pattern signal.

Adjustment Procedure

1. Input a raster signal with the pattern generator.
2. Loosen the deflection yoke mounting screw, and set the purity control to the center as shown below:

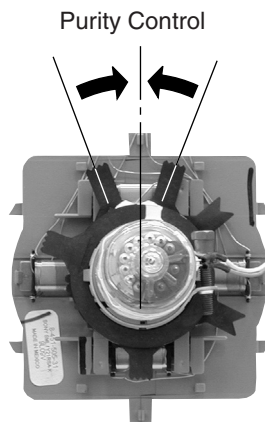

3. Turn the raster signal of the pattern generator to green.
4. Move the deflection yoke backward, and adjust with the purity control so that green is in the center and red and blue are even on both sides.

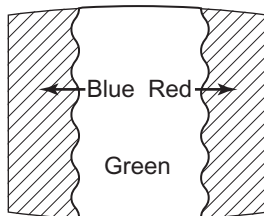

5. Move the deflection yoke forward, and adjust so that the entire screen becomes green.

6. Switch over the raster signal to red and blue and confirm the condition.
7. When the position of the deflection yoke is determined, tighten it with the deflection yoke mounting screw.
8. If landing at the corner is not right, adjust by using the disk magnets.

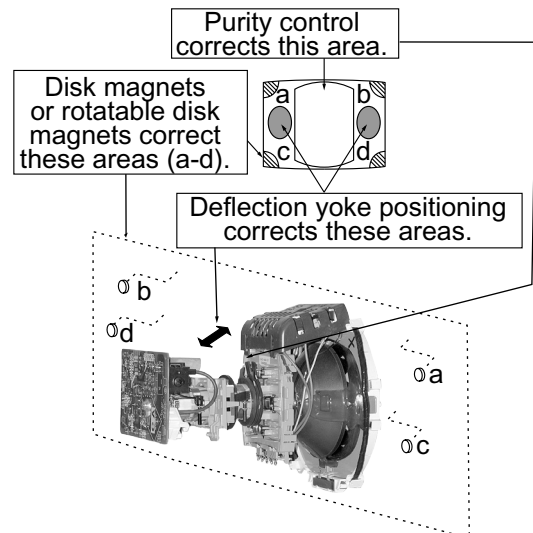
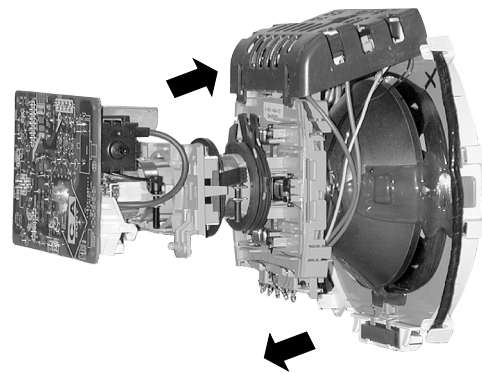

2-2. CONVERGENCE

Before starting convergence adjustments:

- 1 Perform FOCUS, VLIN and VSIZE adjustments.
2. Set BRIGHTNESS control to minimum.
3. Feed in dot pattern.

Vertical Static Convergence

1. Adjust V. STAT magnet to converge red, green and blue dots in the center of the screen (Vertical movement adjust S V.STAT RV1750 to converge).

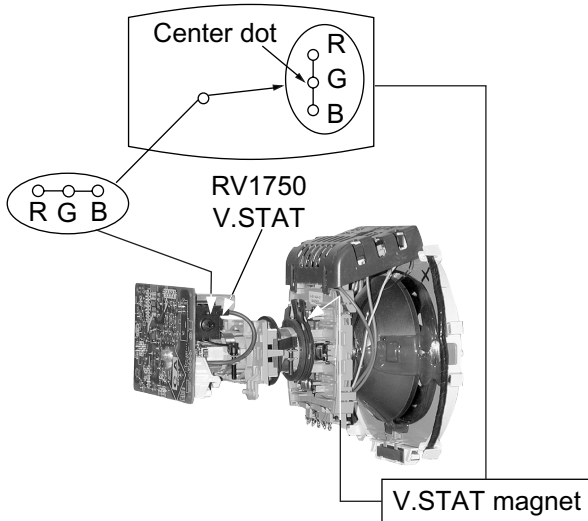

2. Tilt the V. STAT magnet and adjust static convergence to open or close the V. STAT magnet.

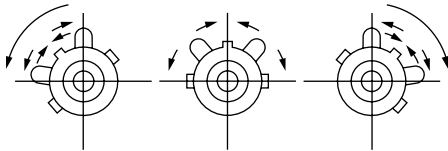

When the V. STAT magnet is moved in the direction of arrow a and b, red, green, and blue dots move as shown below:

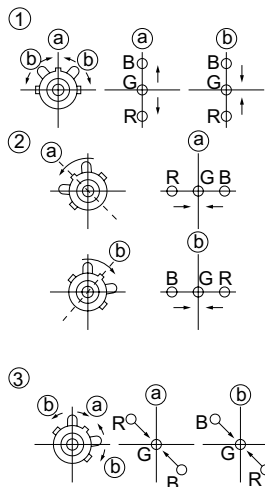

Horizontal Static Convergence

If the blue dot does not converge with the red and green dots, perform the following:

1. Move BMC magnet (a) to correct insufficient H.Static convergence.
2. Rotate BMC magnet (b) to correct insufficient V.Static convergence.
3. After adjusting the BMC magnet, repeat Beam Landing Adjustment.

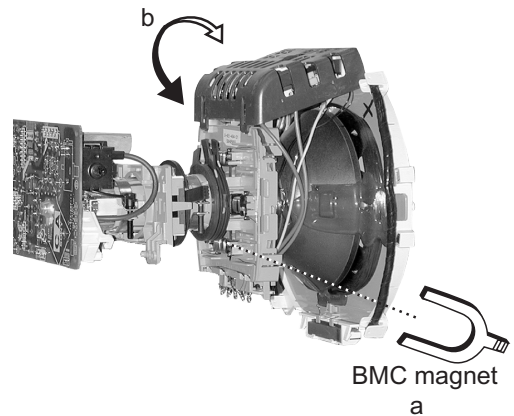
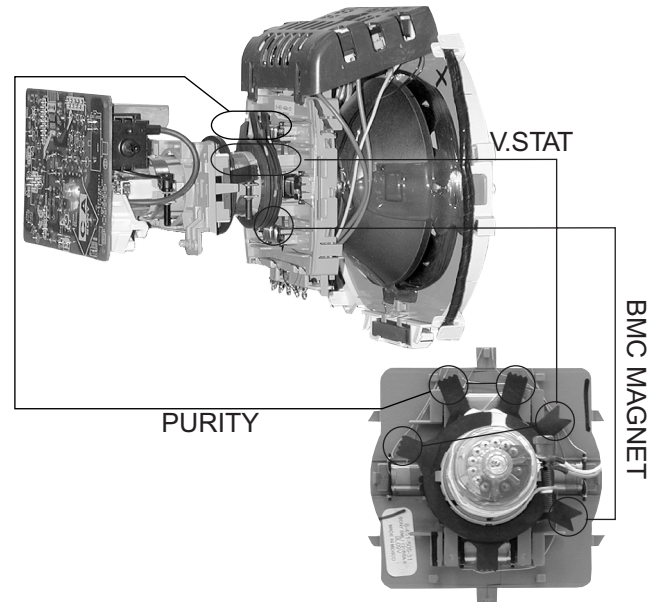

Dynamic Convergence Adjustment

Before performing this adjustment, perform Horizontal and Vertical Static Convergence Adjustment.

1. Slightly loosen deflection yoke screw.
2. Remove deflection yoke spacers.
3. Move the deflection yoke for best convergence as shown below:

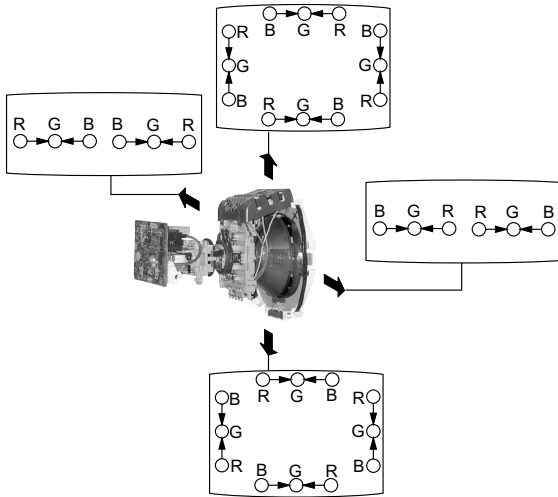

4. Tighten the deflection yoke screw.
5. Install the deflection yoke spacers.

TLH Plate Adjustment

1. Input crosshatch pattern.
2. Adjust PICTURE QUALITY to standard, PICTURE and BRIGHTNESS to 50%, and OTHER to standard.
3. Adjust the Horizontal Convergence of red and blue dots by tilting the TLH plate on the deflection yoke.

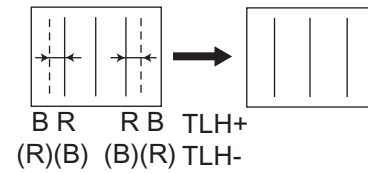
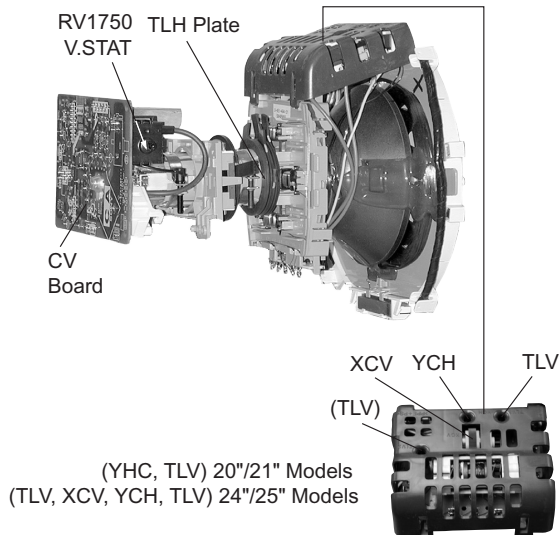

4. Adjust XCV core to balance X axis.
 5. Adjust YCH VR to balance Y axis.
 6. Adjust vertical red and blue convergence with V.TILT (TLV VR.)
- Note: Perform adjustment 3-6 while tracking items 1 and 2.

Screen-Corner Convergence

1. Affix a permalloy assembly corresponding to the misconverged areas:

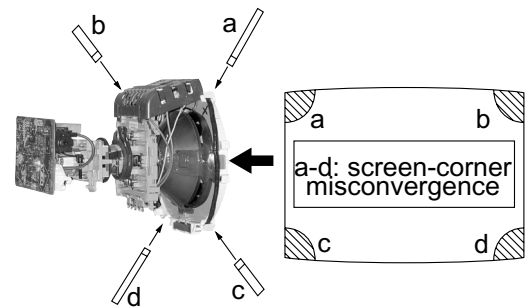

2-3. FOCUS

1. Adjust FOCUS control for best pictures.

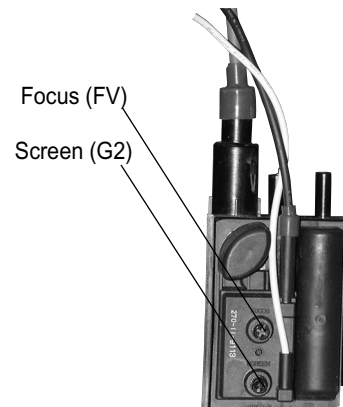

2-4. SCREEN (G2)

1. Input a dot pattern.
2. Set the PICTURE and BRIGHTNESS controls at minimum and COLOR control at normal.
3. Adjust SBRT, GCUT, BCUT in service mode with an oscilloscope as shown below so that voltages on the red, green, and blue cathodes are $160 \pm 2\text{VDC}$.

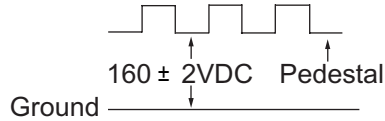

4. Observe the screen and adjust SCREEN (G2) VR in FBT to obtain the faintly visible background of dot signal.

2-5. METHOD OF SETTING THE SERVICE ADJUSTMENT MODE

Service Mode Procedure

1. Standby mode (power off).
2. Press **Display** → Channel **5** → Sound Volume **+** → Power on the Remote Commander (press each button within a second).

Service Adjustment Mode On

1. The CRT displays the time being adjusted.

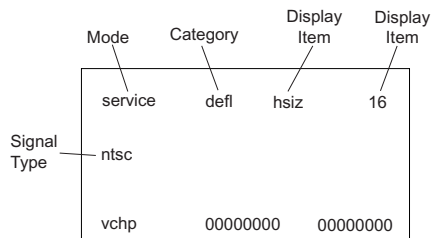

2. Press **1** or **4** on the Remote Commander to select the time.
3. Press **3** or **6** on the Remote Commander to change the data.
4. Press **MUTING** then **ENTER** to save into the memory.

Service Adjustment Mode Memory

Turn the set off then on to exit Service Adjustment Mode.

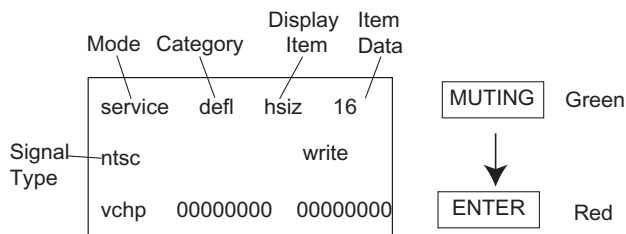



2-6. WHITE BALANCE ADJUSTMENTS

1. Input an entire white signal with burst.
2. Set to Service Adjustment Mode.
3. Set the PICTURE and BRIGHTNESS to minimum.
4. Adjust with SBRT if necessary.
5. Select GCUT and BCUT with **1** and **4**.
6. Adjust with **3** and **6** for the best white balance.
7. Set the PICTURE and BRIGHTNESS to maximum.
8. Select GDRV and BDRV with **1** and **4**.
9. Adjust with **3** and **6** for the best white balance.
10. Press **MUTING** then **ENTER** to save into the memory.

SECTION 3: SAFETY RELATED ADJUSTMENTS

3-1. R565 CONFIRMATION METHOD (HV HOLD-DOWN CONFIRMATION) AND READJUSTMENTS

The following adjustments should always be performed when replacing the following components which are marked with  on the schematic diagram:

Part Replaced ()	Adjustment ()
DY, T585, CRT, IC001, IC561, IC600, C506, C507, C508, T511, L510, C588, L588, C566, C561, C563, D567, D568, D566, PH602, R567, R568, R565, R566, R562, R563, R561, R528.....A Board	HV HOLD-DOWN RV565

Preparation Before Confirmation

- Using a Variac, apply AC input voltage: 120 ± 2 VAC.
- Turn the POWER switch ON.
- Input a white signal and set the PICTURE and BRIGHTNESS controls to maximum.
- Confirm that the voltage between C566 (+) or TP30 and ground is more than 97 VDC for 20"/21" models, or 105 VDC for 24"/25" models.

Hold-Down Operation Confirmation

- Connect the current meter between Pin 11 of the FBT (T585) and the PWB land where Pin 11 would normally attach (See Figure 1 on the next page).
- Input a dot signal and set PICTURE and BRIGHTNESS to minimum: IABL = $100 \pm 100\mu\text{A}$.
- Confirm the voltage of A Board TP-23 is 135.6 ± 1 VDC.
- Connect the digital voltmeter and the DC power supply via Diode 1SS119 to C566 (+) and ground (See Figure 1 on next page).
- Increase the DC power voltage gradually until the picture blanks out.
- Turn DC power source off immediately.
- Read the digital voltmeter indication (standard < 117.0 VDC) for 20"/21" models (standard < 138.0 VDC) for 24"/25" models.
- Input a white signal and set PICTURE and BRIGHTNESS to maximum: IABL = $1350 \pm 100\mu\text{A}$ for 20"/21" models or IABL = $1650 \pm 100\mu\text{A}$ for 24"/25" models
- Repeat steps 4 through 7.

Hold-Down Readjustment

If the setting indicated in Step 2 of Hold-Down Operation Confirmation cannot be met, readjustment should be performed by altering the resistance value of R565 component marked with .

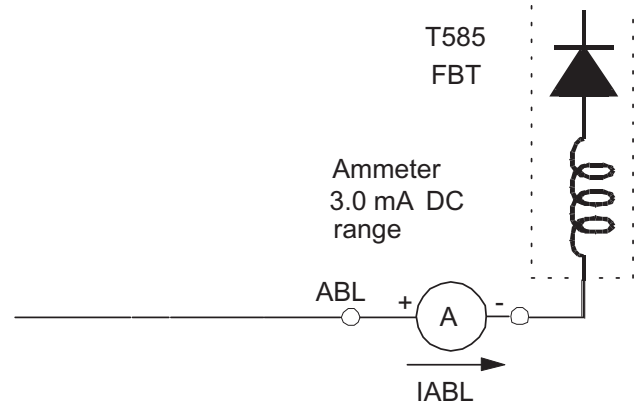

3-2. B+ VOLTAGE CONFIRMATION AND ADJUSTMENT

Note: The following adjustments should always be performed when replacing the following components, which are marked with  on the schematic diagram on the A Board:

A BOARD:  IC600, PH602

- Using a Variac, apply AC input voltage: $130 + 2.0 / - 0.0$ VAC.
- Input a DOT pattern at Q.C.
- Set the PICTURE and the BRIGHTNESS controls to minimum.
- Confirm the voltage of A Board between TP-23 & Ground is $=135.6 \pm 1$ VDC.
- If step 4 is not satisfied, replace the components listed above, then repeat steps 1 through 3.

FIGURE 1

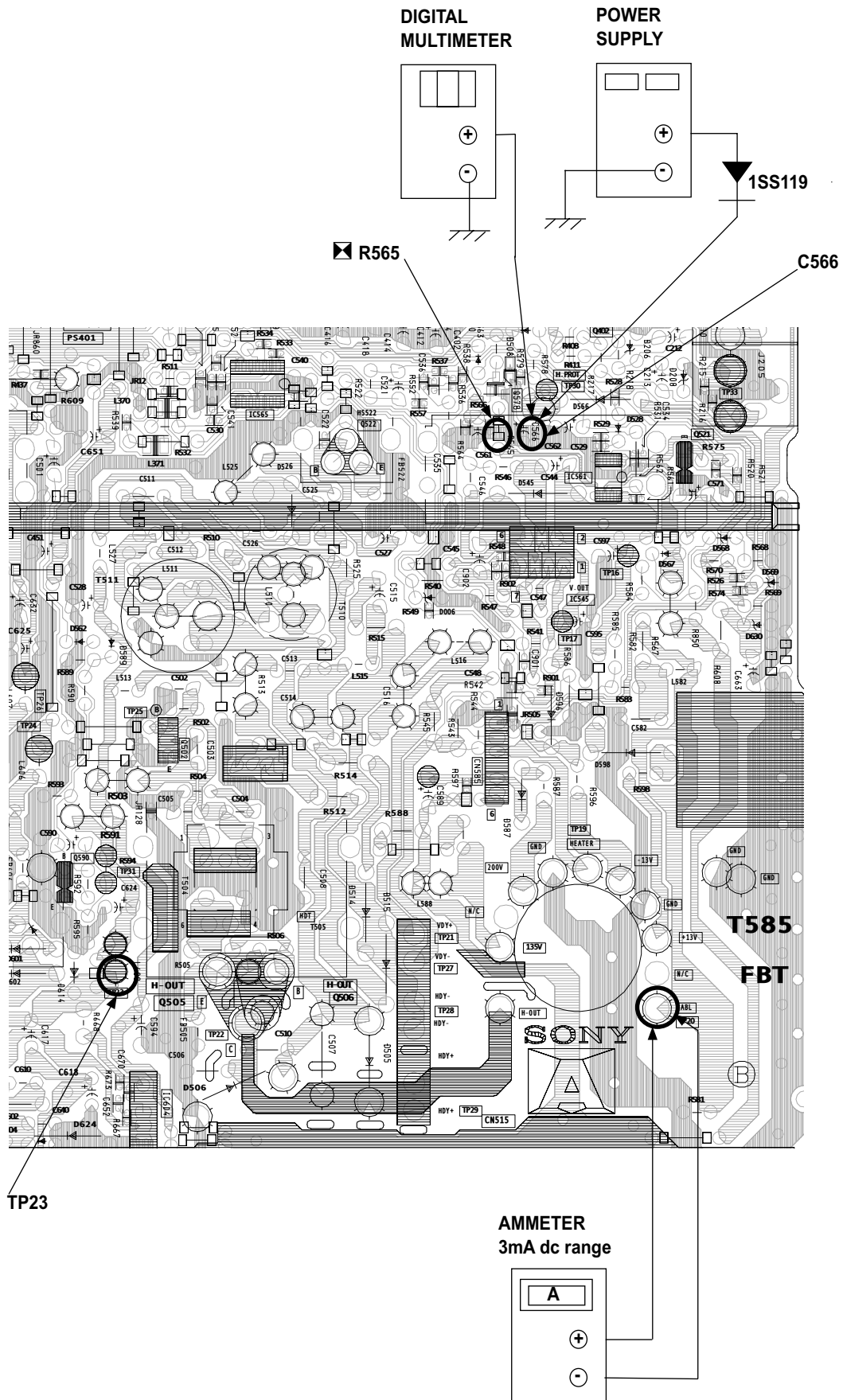

SECTION 4: CIRCUIT ADJUSTMENTS

Electrical Adjustments by Remote Commander

Use the Remote Commander (RM-Y194, RM-W151, RM-Y180) to perform the circuit adjustments in this section.

Test Equipment Required: 1. Pattern generator 2. Frequency counter 3. Digital multimeter 4. Audio oscillator

4-1. SETTING THE SERVICE ADJUSTMENT MODE

- Standby mode (Power off).
- Press the following buttons on the remote commander within a second of each other:

Display → **Channel 5** → **Sound Volume +** → **Power**

Service Adjustment Mode On

- The CRT displays the item being adjusted.

	Mode	Category	Display Item	Item Data
	service	defl	hsiz	16
Signal Type	ntsc			
	vchp	00000000	00000000	

- Press **1** or **4** on the Remote Commander to select the item.
- Press **3** or **6** on the Remote Commander to change the data.
- Press **MUTING** then **ENTER** to write into memory.

Service Adjustment Mode Memory

	Mode	Category	Display Item	Item Data
	service	defl	hsiz	16
Signal Type	ntsc		write	
	vchp	00000000	00000000	

- Press **8** then **ENTER** on the Remote Commander to initialize.

	Mode	Category	Display Item	Item Data
	service	defl	hsiz	16
Signal Type	ntsc		write	
	vchp	00000000	00000000	

Carry out Step 1 when adjusting IDs 0-6 and when replacing and adjusting IC002

- Press **MUTING** then **ENTER** to write into memory.
- Turn set off then on to exit Service Adjustment Mode.

4-2. MEMORY WRITE CONFIRMATION METHOD

- After adjustment, pull out the plug from the AC outlet, then replace the plug in the AC outlet again.
- Turn the power switch ON and set to Service Mode.
- Call the adjusted items again to confirm they were adjusted.

4-3. REMOTE ADJUSTMENT BUTTONS AND INDICATORS

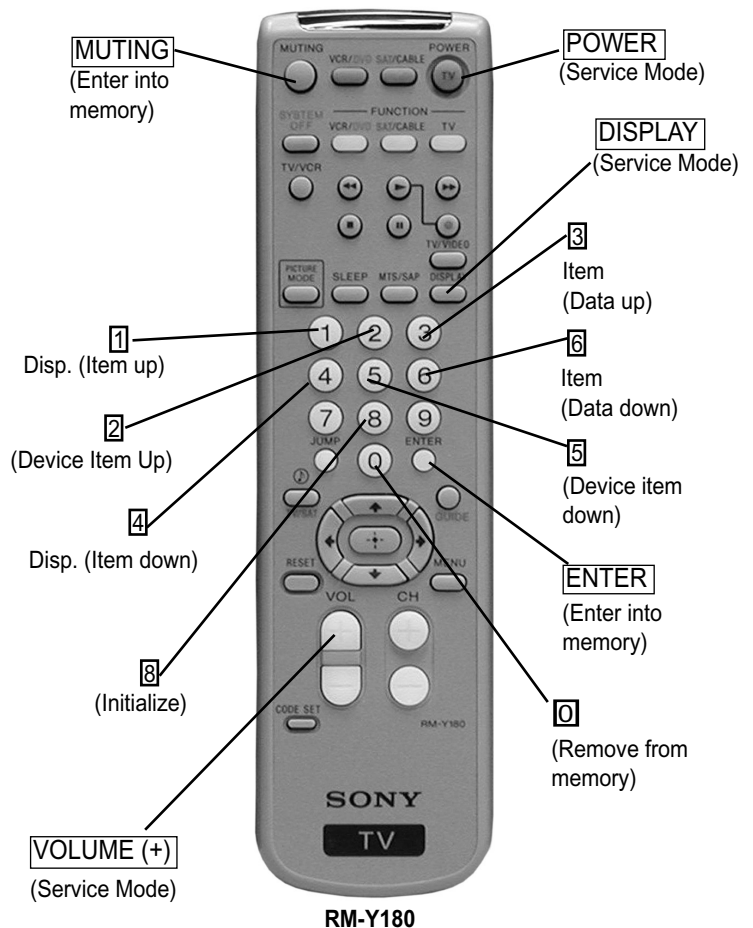

4-4. SERVICE DATA LISTS

Service Group	Fix/ Var	No.	Name	Description	NTSC Init Data
VERSION	Fix	0	VER	Microprocessor version information	=
DEF	VAR	1	HSIZ	H-SIZE (EW DC : YUV OFFSET)	29
	VAR	2	HPOS	H POSITION: YUV OFFSET	37
	VAR	3	VSIZ	V RAMP SIZE: YUV OFFSET	35
	VAR	4	VPOS	V POSITION (RAMP DC) NOT USEFUL: YUV OFFSET	33
	VAR	5	VLIN	V LINEARITY	31
	VAR	6	SCOR	S CORRECTION	26
	VAR	7	VBOW	BOW	37
	VAR	8	VANG	ANGLE	31
	VAR	9	TRAP	EW TRAPESIUM	25
	VAR	10	PAMP	PARABOLA (EW PIN)	9
	VAR	11	UPIN	UPPER CORNER (UPPER PIN)	32
	VAR	12	LPIN	LOWER CORNER (LOWER PIN)	32
	VAR	13	TROT	TROT	109
	VAR	14	HBLK	FBPBLK (H BLK MODE SELECT)	0
	VAR	15	RBLK	HBLK R POS (HBLK REAR TIMING: YUV OFFSET)	15
	VAR	16	LBLK	HBLK F POS (HBLK FRONT TIMING: YUV OFFSET)	48
	FIX	17	VBLK	VBLK POS (V BLK WIDTH)	0
	FIX	18	HMSK	Macro OFF (TOP VEND [WHEN MACROVISION] PREVENT OFF)	0
	FIX	19	HDW	IIC_HOUT_DUTY (H PULSE WIDTH [25u/19u]	1
	FIX	20	AFC	H AFC Gain (AFC GAIN)	0
	FIX	21	AFC1	H Charge pump (AFC1 TIME CONSTANT)	3
	FIX	22	AFCW	AFC1 PULLIN (AFC1 PULL IN WIDE)	0
	FIX	23	CDMD	V CD MODE (V DET WINDOW SW TIMING)	1
	FIX	24	HSS	SYNC SLICE LVL(H) (SYNC SLICE LEVEL [H sepa])	0
	FIX	25	VSS	SYNC SLICE LVL(L) (SYNC SLICE LEVEL [V sepa])	3
	FIX	26	SLDN	AUTO SLICE DOWN (AUTO SLICE LEVEL DOWN)	0
	FIX	27	SLUP	AUTO SLICE UP (AUTO SLICE LEVEL UP)	0
	FIX	28	JPSW	VJPSW (JUMP SW)	0
	FIX	29	HOSC	H VCO FOR OFFSET ADJUST OFFSET	5
	FIX	30	EHT	EHT	4
	FIX	31	EHTG	EHT GAIN (EHT MODE)	1

Service Group	Fix/ Var	No.	Name	Item name & (Description)	NTSC Init Data
16:9	VAR	1	VSIZ	V RAMP SIZE	55
	VAR	2	VPOS	V POSITION (RAMP DC)	37
	VAR	3	VLIN	V LINEARITY	30
	VAR	4	SCOR	S CORRECTION	20
	VAR	5	TRAP	EW TRAPESIUM	30
	VAR	6	PAMP	PARABOLA (EW PIN)	0
	VAR	7	UPIN	UPPER CORNER (UPPER PIN)	34
	VAR	8	LPIN	LOWER CORNER (LOWER PIN)	32
	VAR	9	ABLG	ABL GAIN	15
	VAR	10	SCON	SUB CONTRAST LEVEL	10
	VAR	11	VPW	JUMP PULSE WIDTH	1

Service Group	Fix/ Var	No.	Name	Item name & (Description)	NTSC Init Data	Video	YUV	16:09
VP1	VAR	1	RDRV	R DRIVE	45	45	45	N/A
	VAR	2	GDRV	G DRIVE: GDOF OFFSET (only Color Temp. "Warm")	28	28	30	N/A
	VAR	3	BDRV	B DRIVE: BDOF OFFSET (only Color Temp. "Warm")	33	33	29	N/A
	VAR	4	RCUT	HARDWARE AKB (R) CMP DATA	120	120	120	N/A
	VAR	5	GCUT	HARDWARE AKB (G) CMP DATA	98	98	72	N/A
	VAR	6	BCUT	HARDWARE AKB (B) CMP DATA	102	102	91	N/A
	VAR	7	SCON	SUB CONTRAST LEVEL	16	16	16	N/A
	VAR	8	SHUE	SUB TINT (HUE)	7	7	7	N/A
	VAR	9	SCOL	SUB COLOR LEVEL	17	17	27	N/A
	VAR	10	SBRT	SUB BRIGHTNESS	11	11	14	N/A
	FIX	11	RON	R OUTPUT ON (0:R OUTPUT OFF 1:R OUTPUT ON)	1			
	FIX	12	GON	G OUTPUT ON (0:R OUTPUT OFF 1:R OUTPUT ON)	1			
	FIX	13	BON	B OUTPUT ON (0:R OUTPUT OFF 1:R OUTPUT ON)	1			

Service Group	Fix/ Var	No.	Name	Item name & (Description)	NTSC Init Data	Video	YUV	16:09
VP1	FIX	14	BLLV	BLUE STRETCH (00:NO<->11:DEEP) only Color Temp "Cool"	1			
	FIX	15	MTRX	MATRIX RATIO SELECT	0			
	FIX	16	AXIS	R-Y PHASE SELECT	52			
	VAR	17	SSHO	SUB SHARPNESS GAIN (OVER) RF/VIDEO	10	26	25	N/A
	VAR	18	SSHP	SUB SHARPNESS GAIN (PRE) RF/VIDEO	15	31	30	N/A
	VAR	19	SHPF	SHARPNESS FOR (00:2 CLK <-> 11:5 CLK)	1	0	0	N/A
	FIX	20	SHCL	SHARPNESS CORING LEVEL	0			
	FIX	21	SHMX	SHARPNESS LIMITER LEVEL	15			
	FIX	22	ACLV	ACL GAIN	0			
	FIX	23	AKBD	AKB SELF DIAGNOSTIC COUNTER (@1 SEC)	2			
	FIX	24	AKBS	AKB SWITCH (0:AKB OFF 1:H/W AKB ON)	1			
	FIX	25	REFP	AKB REFPLS TIMING	0			
	FIX	26	YNRC	YNR LIMITER LEVEL	15			
	FIX	27	BKON	BLACK STRETCH ON	1			
	FIX	28	BKAT	BLACK STRETCH DETECTOR TIME CONSTANT1	15			
	FIX	29	BKRC	BLACK STRETCH DETECTOR TIME CONSTANT2	4			
	FIX	30	BKDP	BLACK STRETCH DEPTH	soft cont'l			
	FIX	31	BKSP	BLKSTPNT BLACK STRETCH POINT	2			

Service Group	Fix/ Var	No.	Name	Item name & (Description)	NTSC Init Data	Video	YUV	16:09
VP2	FIX	1	VMOF	VM GAIN(Off) (VM LEVEL AT "OFF" SETTING)	2			
	FIX	2	VMLO	VM GAIN(Low) (VM LEVEL AT "LOW" SETTING)	4			
	FIX	3	VMHI	VM GAIN(High) (VM LEVEL AT "HIGH"SETTING)	8			
	FIX	4	VMDL	VM DELAY (VM DELAY)	6			
	FIX	5	VMPL	VM POL (VM POLARITY)	0			
	FIX	6	VMWD	VM WIDTH (VM WIDTH)	0			
	FIX	7	VMCL	VM CORING LEVEL (VM CORING LEVEL)	0			
	FIX	8	VMMX	VM MAX (VM LIMITER LEVEL)	15			
	FIX	9	CKLV	KILLER LEVEL (VM COLOR KILLER VTH)	1	1	0	N/A
	FIX	10	CKON	FORCE KILLER (FORCE KILLER)	0			
	FIX	11	ALFA	ALFA (ADAPTIVE DET SENSITIVITY)	2			
	FIX	12	YCMD	MANEXP (YC SEPA FORCE SELECT [00:ADAPTIVE 01:H 10:V 11:HV])	0			
	FIX	13	VACL	V APERTURE CORING LV (V APERTURE CORING LEVEL)	0			
	FIX	14	VAGA	V APERTURE GAIN (V APERTURE GAIN LEVEL)	soft cont'l			
	FIX	15	VAMX	V APERTURE MAX GAIN (V APERTURE LIMITER LEVEL)	5			
	FIX	16	GAMM	GAMMA (GAMMA [00:NO <-> 11:DEEP])	soft cont'l			
	FIX	17	YDLY	Y DELAY (Y DELAY TIME)	1	1	3	N/A
	FIX	18	CDLY	C DELAY (C DELAY TIME)	0			
	FIX	19	YOFF	Y Mute (Y OUTPUT MUTE)	0			
	FIX	20	CBPF	SAW FILTER(7.2MHzBPF) (C BPF FOR HI)	0			
	FIX	21	BGPP	BGP POS (BGP [FOR C DECODER] TIMING)	9	9	28	N/A
	VAR	22	GDOF	G DRIVE OFFSET only Color Temp. "Warm"	9			
	VAR	23	BDOF	B DRIVE OFFSET only Color Temp. "Warm"	14			
	VAR	24	GCOF	G CUT CMP DATA OFFSET only Color Temp. "Warm"	11			
	VAR	25	BCOF	B CUT CMP DATA OFFSET only Color Temp. "Warm"	28			
	VAR	26	DCTV	DCTRAN VTH<6:0> (DCTTRANSFER VTH)	30			
	FIX	27	DCTG	DCTRAN GAIN<4:0> (DCTTRANSFER GAIN)	soft cont'l			

Service Group	Fix/ Var	No.	Name	Item name & (Description)	NTSC Init Data
NR	VAR	1	SCOL	SUB COLOR LEVEL	17
	VAR	2	SHCL	SHARPNESS CORING LEVEL	15
	VAR	3	SHMX	SHARPNESS LIMITER LEVEL	7
	FIX	4	YNRC	YNR LIMITER LEVEL	7
	FIX	5	VMHI	VM LEVEL AT " HIGH " SETTING	10
	FIX	6	VMCL	VM CORING LEVEL	0
	FIX	7	VMMX	VM LIMITER LEVEL	7
	FIX	8	VAMX	V APERTURE LIMITER LEVEL	0
	FIX	9	GAMM	GAMMA (00: NO < - > 11:DEEP)	0
	FIX	10	YNRS	YNR ON	1
	FIX	11	WSTH	WEAK SIGNAL VTH	7
	FIX	12	WSVA	WEAK SIGNAL VIDEO ATT	0
	FIX	13	WSCA	WEAK SIGNAL CHROMA ATT	5
	FIX	14	NRCH	THRNV1(NOISE DET TIME CONSTANT)	0
	FIX	15	NRCL	THRNV2 (NOISE DET TIME CONSTANT)	16
	FIX	16	NRVL	THRNV1 (NOISE DET VTH)	2
	FIX	17	NRVH	THRNV2 (NOISE DET VTH)	0
	FIX	18	IPNC	DETNZ STATUS COUNTER	2
	FIX	19	IPNV	DETECTION PERIOD	10

Service Group	Fix/ Var	No.	Name	Item name & (Description)	NTSC BA6 DATA (DEC)			
					PALLET = VIVID	PALLET = STD	PALLET = MOVIE	PALLET = PRO
PALLET	FIX	1	VPIC	PICTURE	63	50	37	31
	FIX	2	VBRI	BRIGHTNESS	27	30	31	31
	FIX	3	VCOL	COLOR	37	32	31	31
	FIX	4	VHUE	HUE	31	31	31	31
	FIX	5	VSHA	SHARPNESS	31	32	31	21
	FIX	6	VVM	VM	2	1	0	0
	FIX	7	VTRI	COLOR TEMP	0	1	2	1
	FIX	8	VAPA	APERTURE G	5	5	3	0
	FIX	9	VGMA	GAMMA	3	1	0	0
	FIX	10	VDCT	DCT LV	23	15	2	2
	FIX	11	VBKP	BLACK STRETCH DEPTH (VIDEO)	3	3	4	7
	FIX	12	TBKD	BLACK STRETCH DEPTH (TUNER)	3	3	4	7

Service Group	Fix/ Var	No.	Name	Item name & (Description)	NTSC Init Data
Y	FIX	1	YNRS	YNR SW (YNR ON)	0
	FIX	2	YTHR	Y THR 2D (Y SIGNAL THROUGH 2DYCS)	0
	FIX	3	Y2D	Y2D Fix (Y SIGNAL GENERATE from 2DYCS)	0
	FIX	4	2DFX	C BPF Fix (C SIGNAL GENERATE from H/V BPF only	1
	FIX	5	CLPS	CLAMP CONTROL SW (0: CLAMP OFF. 1: CLAMP AUTO. 2: CLAMP ON]	1
	FIX	6	VLPF	VIDEO LPF (Y_LPF [ANALOG] for adjust)	3
	FIX	7	CLPF	CHROMA LPF (C_LPF [ANALOG] for adjust)	3
	FIX	8	BPFB	YCS HBPF BACK (YCS HBPF SELECT [BACK])	1
	FIX	9	BPFF	YCS HBPF FRONT (YCS HBPF SELECT [FRONT])	1
	FIX	10	BKTS	BS T2 IFON (BLACK STRETCH RECOVER TIME OUT	0
	FIX	11	VMG ₂	VMGAIN ₂ (MODULATOR FEEDBACK GAIN CONTROL	2
	FIX	12	CLPT	CLAMP KEEP TIMER (CLAMP AUTO ON KEEP TIMER COUNT [@ 100 MS])	15

Service Group	Fix/ Var	No.	Name	Item name & (Description)	A8 Init Data	Video	YUV	16:09
C	FIX	1	A1FL	AMP OFF1 L (ANALOG ACC hysteresis)	90			
	FIX	2	A1ON	AMP ON (ANALOG ACC AMP ON LEVEL)	4			
	FIX	3	ACCS	ACC SW (ACC ON/OFF)	0	0	1	N/A
	FIX	4	AASL	AVE SEL (C DECODER TIME CONSTANT [32, 16, 8, 1H])	2			
	FIX	5	BASL	B2AVE SEL (ACC TIME CONSTANT)	0			
	FIX	6	XFFR	FREE RUN (VCXO FORCE FREERUN)	0	0	1	N/A
	FIX	7	A2ON	AMP2 ON Thresh (ABL VTH)	4			
	FIX	8	A3ON	AMP3 ON Thresh (ACL VTH)	4			
	FIX	9	A2FL	AMP2 OFF Thresh L (AMP2 OFF LEVEL LOWER)	64			
	FIX	10	A3FL	AMP3 OFF Thresh L (AMP3 OFF LEVEL LOWER)	64			
	FIX	11	AXTH	AXIS HYS (AXS HYS)	30			
	FIX	12	ACTH	ROM HYS (ROM HYS)	10			
	FIX	13	AVAV	AVE SEL AV (AVE SEL AV)	3			
	FIX	14	B2TH	B2COMP (B2COMP)	0			
	FIX	15	ACCP	ACC COMP (ACC COMP)	0			

Service Group	Fix/ Var	No.	Name	Item name & (Description)	NTSC Init Data	Video	YUV	16:09
RGB	FIX	1	AMUT	RGB POWER ON MUTE (RGB POWER ON MUTE)	0			
	FIX	2	PMUT	RGB Mute before OSD (RGB MUTE [EXCEPT OSD])	1			
	FIX	3	CORL	CUTOFF R L (R CUTOFF LOWER)	212			
	FIX	4	CORH	CUTOFF R H (R CUTOFF UPPER)	0			
	FIX	5	COGL	CUTOFF G L (G CUTOFF LOWER WHEN TEMP IS "COOL" AND "NEUTRAL"	197			
	FIX	6	COGH	CUTOFF G H (G CUTOFF LOWER WHEN TEMP IS "COOL" AND "NEUTRAL"	0			
	FIX	7	COBL	CUTOFF B L (B CUT OFF LOWER WHEN TEMP IS "COOL" AND "NEUTRAL"	176			
	FIX	8	COBH	CUTOFF B H (B CUT OFF LOWER WHEN TEMP IS "COOL" AND "NEUTRAL"	0			
	FIX	9	ABLS	ABL SEL (ABL SELECT)	0			
	FIX	10	ALSP	ACL SPEED (ACL SPEED)	0			
	FIX	11	ALRS	ACL SPE (ACL RECOVER SPEED)	2			
	FIX	12	ALAS	ACL ASPE (ACL ATTACK SPEED)	9			
	FIX	13	ABLG	ABL GAIN (ABL GAIN)	5			
	FIX	14	ALS2	ACLASPE2 (ACL ATTACK SPEED [2])	2			
	FIX	15	AKBM	AKB MODE (AKB MODE)	0			
	FIX	16	AKBP	AKB P[5:0] (AKB PULSE HEIGHT)	16			
	FIX	17	OSDL	OSD LIMIT (OSD LIMMIT SELECT)	0			
	FIX	18	UVIN	Y/U/V UVINV (U/V INVERT)	0			
	FIX	19	UVG	U/V GAIN (U/V OFFSET CANCELER ON)	0			
	FIX	20	UOFS	U IN OFFSET (U IN OFF SET)	7			
	FIX	21	VOFS	V IN OFFSET (V IN OFFSET)	15			
	FIX	22	AALG	ANA ACL GAIN (ANALOG ACL GAIN CONTROL)	0			
	FIX	23	AALS	ANA ACL ON (ANALOG ACL ON/OFF CONTROL)	1			
	FIX	24	UVDE	UV_DITHER_EN (UVIN DITHER ENABLE)	0	0	1	N/A
	FIX	25	UVDT	UV_DITHER_TEST (UVIN DITHER TEST)	0	0	6	N/A

Service Group	Fix/ Var	No.	Name	Item name & (Description)	NTSC Init Data	Video	YUV	16:09
DELD	FIX	1	HFFR	AFC FREE RUN (AFC1 FORCE FREE RUN)	0			
	FIX	2	HFUP	HFREE UP (H FREE RUN FREQUENCY UP [700 Hz])	0			
	FIX	3	JSWW	VJP WIDTH (JUMP PULSE WIDTH)	0			
	FIX	4	EWCL	V/EW DAC CLK CONTROL (EW/VRAMP DA CLOCK SELECT)	0	0	0	N/A
	FIX	5	XF0A	FREE RUN OFFSET (VCXO FREE RUN ADJUST)	0			
	FIX	6	BGST	BG START (BGP [FOR PLL] TIMING)	16	16	1	N/A
	FIX	7	XPHA	VCXO CTL (VXCO PHASE ADJUST)	10			
	FIX	8	HRMP	Ramp Slew Rate (AFC2 TIME CONSTANT)	3			
	FIX	9	RPLU	Ref Charge pump (REF PLL TIME CONSTANT)	3			
	FIX	10	RPLB	Ref VCO (REF PLL TIME CONSTANT)	1			
	FIX	11	XF0B	VCXO FREE RUN (VXCO Fo ADJUST)	0			
	FIX	12	RPLS	REF FB SW (REF VCO FB LOOP SELECT)	0			
	FIX	13	SSM	Sync Sepa Mask (SyncSepaMasking CONTROL)	0			
	FIX	14	VSAG	V-sag (V-SAG prevent ON)	0			
	FIX	15	AFC2	AFC2 Gain (AFC2 GAIN CONTROL)	3			
	FIX	16	VRFL	V RAMP FIL OFF (V RAMP FILTER SWITCHING OFF)	1			
	FIX	17	SSLP	LPY SYNC (LFP pre SYNC SEPA ON/OFF)	1			
	FIX	18	XPLU	B PLL Change pump (ACP TIME CONSTANT)	1			
	FIX	19	8FSC	8FSC SEL (8fsCLK Skew OFF)	1	1	0	N/A
	FIX	20	4FS2	4FSC SEL2 (4fsCLK Skew OFF)	1	1	0	N/A
	FIX	21	CDM2	V_CD_MODE2 (V_LOGIC SW)	1			
	FIX	22	BGPC	Add. FTN BGP C (BGP C)	0			
	FIX	23	MHDL	Add. FTN BGP SEL (BBP SEL)	1			
	FIX	24	BFRE	V FREE (FORCE V FREE RUN)	0			

Service Group	Fix/ Var	No.	Name	Item name & (Description)	NTSC Init Data	Video	YUV	16:09
DEFD	FIX	25	HRPP	AFC2 RAMP POS (FRAMP RRAMP H OUT CONTROL RANGE	8			
	FIX	26	DSCK	CLOCK SEL (DS DAC CLK SW 2)	1	1	1	0
	FIX	27	VBHK	VBK HALFKIL (V BLK HALF KILL)	0			
	FIX	28	VPW	V PLS WIDTH (V Pulse Wide)	1			
	FIX	29	DTH	D THRESHOLD LEVEL (DITHER THRESHOLD LEVEL CONTROL AT IIC AUTOD= ON	0			
	FIX	30	SLON	LPF SYNC ON (LPF SYNC ON)	1			
	FIX	31	VSSW	SYNC SLICE LVL(V)_W (SYNC SLICE LEVEL [V] Wide Window	0			
	FIX	32	AF2S	AFC2_SEL (ADC2 TIMING SW)	0			
	FIX	33	VSL2	V_SYNC_LPF_2 (DIGITAL V_SINC_LPF [Fall])	0			
	FIX	34	VSL1	V_SYNC_LPF_1 (DIGITAL V_SINC_LPF [Rise])	1			
	FIX	35	VYUV	YUV VSIZE OFFSET (YUV V-SIZE OFFSET)	8			
	FIX	36	VYVP	YUV VPOS OFFSET (YUV V-POSITION OFFSET)	8			
	FIX	37	VYHS	YUV HSIZE OFFSET (YUV H-SIZE OFFSET)	8			
	FIX	38	VYHP	YUV HPOS OFFSET (YUV H-POSITION OFFSET)	7			
	FIX	39	VSHE	V-SHRINK MODE (V-SHRINK MODE for AV)	0			
	FIX	40	VYRB	YUV RBLK (YUV RBLK OFFSET)	7			
	FIX	41	VYLB	YUV LBLK (YUV LBLK OFFSET)	7			

Service Group	Fix/ Var	No.	Name	Item name & (Description)	NTSC Init Data	Video	YUV	16:09
OTHER	FIX	1	PCLP	pedestal CLAMP ON/OFF (SYNC TIP/PEDESTAL CLAMP SELECT)	0			
	FIX	2	VRT	VRT Voltage (ADC REFERENCE [00:1.15Vpp 01:1.25 Vpp 10:1.35 Vpp 11:1.45 Vpp])	1			
	FIX	3	14HI	INV 14H CLK (4fsc [Skew] CLK POLARITY)	0	0	0	N/A
	FIX	4	14HD	14H CLK DLY (4fscCLK [Skew] CLK DELAY ADJUST)	0	0	0	N/A
	FIX	5	DSI	INV DS CLK (8fscCLK POLARITY)	0	0	0	N/A
	FIX	6	DSD	DS CLK DLY (8fscCLK DELAY ADJUST)	0	0	0	N/A
	FIX	7	ADCD	AD CLK DLY (ADC CLK DELAY ADJUSTO)	0	0	1	N/A
	FIX	8	4FSC	4FSC SW (AD/LOGIC CLK SWAP)	0			
	FIX	9	WSTH	WEAK_SIG_VTH (WEAK_SIGNAL VTH)	0			
	FIX	10	WSVA	WEAK_SIG VIDEO ATT (WEAK SIGNAL VIDEO ATT)	0	0	0	N/A
	FIX	11	WSCA	WEAK_SIG CHROMA ATT (WEAK SIGNAL CHROMA ATT)	0	0	0	N/A
	FIX	12	VREF	VREF_SEL (AD REFERENCE SELECT [VZ])	0			

Service Group	Fix/ Var	No.	Name	Item name & (Description)	NTSC Init Data
OSD	FIX	1	HT	HT (HALF TONE LEVEL)	0
	FIX	2	OSLR	OSD LVL R (R OSD LEVEL)	25
	FIX	3	OSLG	OSD LVL G (G OSD LEVEL)	25
	FIX	4	OSDC	OSD COMP (OSD COMP)	0
	FIX	5	OSLB	OSD LVL B (B OSD LEVEL)	25

Service Group	Fix/ Var	No.	Name	Item name & (Description)	NTSC Init Data
H/W AKB	FIX	1	HRIL	H/W AKB R INI DATA L (H/W AKB RED OUTPUT LOWER)	soft cont'l
	FIX	2	HRIH	H/W AKB R INI DATA H (H/W AKB RED OUTPUT UPPER)	soft cont'l
	FIX	3	HGIL	H/W AKB G INI DATA L (H/W AKB GREEN OUTPUT LOWER)	soft cont'l
	FIX	4	HGIH	H/W AKB G INI DATA H (H/W AKB GREEN OUTPUT UPPER)	soft cont'l
	FIX	5	HBIL	H/W AKB B INI DATA L (H/W AKB BLUE OUTPUT LOWER)	soft cont'l
	FIX	6	HBIH	H/W AKB B INI DATA H (H/W AKB BLUE OUTPUT UPPER)	soft cont'l
	FIX	7	HLM1	AKB_LIM1<7:0> (H/W AKB LIM1)	6
	FIX	8	HLM2	AKB_LIM2<7:0> (H/W AKB LIM2)	12
	FIX	9	HLM3	AKA_LIM3<7:0> (H/W AKB LIM3)	21
	FIX	10	HAD1	AKB_ADD1<7:0> (H/W AKB SPEED1)	2
	FIX	11	HAD2	AKB_ADD2<7:0> (H/W AKB SPEED2)	6
	FIX	12	HAKA	AKB_EN (H/W AKB MANUAL [MCU] / HARD	1
	FIX	13	HASP	AKB_SPEED (H/W AKB SPEED)	3
	FIX	14	HERL	AKB_SWERR<7:0> (H/W AKB ERROR DET THRESH)	40
	FIX	15	HLMC	AKB_ERRC<7:0> (H/W AKB ERROR DET TIME)	20
	FIX	16	HPWL	AKBSWPON<7:0> (H/W AKB POWER ON TRESH)	4
	FIX	17	HPWC	AKB_PWERRC (H/W AKB POWER ON TIME)	90
	FIX	18	HFMT	H/W AKB2 HOLD TIMER (H/W AKB2 HOLD TIMER (@ 100 MSEC) [0: No hold]	20
	FIX	19	SPMT	AKB POW ON MUTE EXIT (AKB POWER ON MUTE EXIT TIMMER)	120

Service Group	Fix/ Var	No.	Name	Item name & (Description)	NTSC 21FA310	20FS120	21FM120	24FS120
AUDIO PROCESSOR	VAR	1	SBAL	SBAL (SUB BALANCE)	4	4	4	4
	VAR	2	SBAS	SBAS (SUB BASS)	0	6	4	7
	VAR	3	STRE	STRE (SUB TREBLE)	0	7	7	7
	VAR	4	SRL	SRL (SURROUND LEVEL)	0	0	0	0
	VAR	5	BBOL	BBOL (SURROUND OFF-BBE LOW)	4	0	0	0
	VAR	6	BBOH	BBOH (SURROUND OFF-BBE HIGH)	7	0	0	0
	VAR	7	BBSL	BBSL (SIMULATE BBE LOW)	2	0	0	0
	VAR	8	BBSH	BBSH (SIMULATE BBE HIGH)	7	0	0	0
	VAR	9	BBGL	BBGL (WOW GAME BBE LOW)	4	0	0	0
	VAR	10	BBGH	BBGH (WOW GAME BBE HIGH)	9	0	0	0
	VAR	11	BBTL	BBTL (SRS BBE LOW)	0	0	0	0
	VAR	12	BBTH	BBTH (SRS BBE HIGH)	0	0	0	0
	VAR	13	BBDL	BBDL (Audio Processor Prologic BBE Low for DOLBY)	3	0	0	0
	VAR	14	BBDH	BBDH (Audio Processor Prologic BBE High for DOLBY)	5	0	0	0
	VAR	15	VFIX	VFIX (AUDIO OUTPUT FIX DATA)	0	0	0	0
	VAR	16	AGCL	AGCL (AGC LEVEL)	2	2	2	2
	VAR	17	VCOF	RF OFFSET DATA	9	9	9	9

Service Group	Fix/ Var	No.	Name	Item name & (Description)	NTSC 21FA310	20FS120	21FM120	24FS120
AP2	VAR	1	BBEL	SUB AUDIO PROCESSOR PROLOGIC BBE LOW	2	0	0	0
	VAR	2	BBEH	SUB AUDIO PROCESSOR PROLOGIC BBE HIGH	5	0	0	0
	VAR	3	BBOL	SURROUND OFF-BBE LOW	2	0	0	0
	VAR	4	BBSL	SIMULATE BBE LOW	2	0	0	0
	VAR	5	BBGL	WOW GAME BBE LOW	3	0	0	0
	VAR	6	AGCL	SUB AUDIO PROCESSOR AGC LEVEL	2	0	0	0
	VAR	7	DDOF	DOLBY OFFSET DATA	15	0	0	0

Service Group	Fix/ Var	No.	Name	Item name & (Description)	NTSC Init Data
MICROPROCESSOR	FIX	1	DISP	DISP (OSD HORIZONTAL OFFSET)	55
	FIX	2	CCHP	CCHP (FOR TILT DATA CALCULATION)	80
	FIX	3	HRLW	HRLW (LOW LIMIT OF H-PULSE COUNTING WINDOW [RF]	16
	FIX	4	HRHG	HRLG (HIGH LIMIT OF H-PULSE COUNTING WINDOW [RF]	64
	FIX	5	HSDT	HSDTCT (H-PULSE DETECTION [S-VIDEO]	8
	FIX	6	STPI	STPI (GRADUAL CONTRAST INCREASE STARTING LEVEL)	40
	FIX	7	RAPI	RAPI (GRADUAL CONTRAST INCREASE Vsync COUNTER)	10

Service Group	Fix/ Var	No.	Name	Item name & (Description)	NTSC Init Data
Feature	VAR		ID0	Language related	81
	VAR		ID1	Video related	23
	VAR		ID2	Audio related	113
	VAR		ID3	Miscellaneous	130
	VAR		ID4	Miscellaneous	32
	VAR		ID5	Miscellaneous	16
	VAR		ID6	Miscellaneous	48
	VAR		ID7	Miscellaneous	69

4-5. ID MAP TABLE

Model	Destination	ID-O	ID-1	ID-2	ID-3	ID-4	ID-5	ID-6	ID-7
KV-20FS120	US	89	7	9	34	0	16	0	5
KV-20FS120	CND	89	7	9	50	0	16	0	5
KV-21FM120	L NORTH	81	3	0	130	32	16	48	69
KV-21FS120	L NORTH	81	7	9	130	32	16	48	69
KV-21FS120	L SOUTH	81	7	9	130	32	16	48	69
KV-21FA310	L NORTH	81	23	113	130	32	16	48	69
KV-21FA310	L SOUTH	81	23	113	130	32	16	48	69
KV-24FS120	US	89	23	9	34	0	16	0	5
KV-24FS120	CND	89	23	9	50	0	16	0	5
KV-25FS120	L NORTH	81	23	9	130	32	16	48	69
KV-25FS120	L SOUTH	81	23	9	130	32	16	48	69

4-6. A BOARD ADJUSTMENTS

H. Frequency (Free Run) Check

1. Input a TV mode (RF) with no signal.
2. Connect a frequency counter to base of Q502 (TP-25 H. DRIVE) on the A Board.
3. Check H. Frequency for 15735 ± 200 Hz.

V. Frequency (Free Run) Check

1. Select video 1 with no signal input.
2. Set the conditions for a standard setting.
3. Connect the frequency counter to TP-27 (V OUT) or CN515 pin ⑥ (V DY+) and ground on the A Board.
4. Check that V. Frequency shows 60 ± 4 Hz.

Drive (SCON)

1. Input a color-bar signal and set the level to 75%.
2. Set in Pro mode + PICTURE MAX.
3. Activate the Service Adjustment Mode.

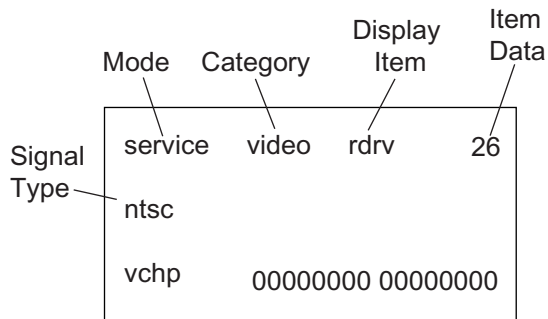

R ON: ON (1)
G ON: OFF (0)
B ON: OFF (0)

4. Connect an oscilloscope probe to CV Board, J1751Pin 12 (KR) (Red Out).

5. Select SCON with **[1]** and **[4]**.
6. Adjust the value of SCON with **[3]** and **[6]** for $86 \pm 3V_{pp}$ for 20/21 inch, and $96 \pm 3V_{pp}$ for 24/25 inch.

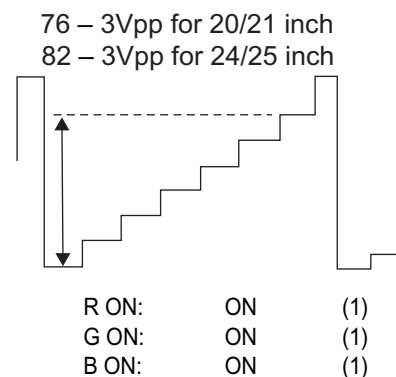

7. Press **[MUTING]** then **[ENTER]** to save into the memory.

Display Position Adjustment (DISP)

1. Input a color-bar signal.
2. Set to Service Adjustment Mode.
3. Select DISP with **[1]** and **[4]**.
4. Adjust values of DISP with **[3]** and **[6]** to adjust characters to the center.
5. Press **[MUTING]** then **[ENTER]** to save into the memory.
6. Check to see if the text is displayed on the screen.

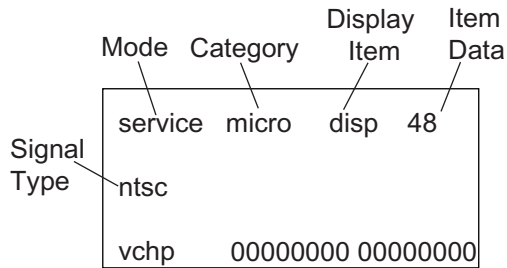

Sub Bright Adjustment (SBRT)

1. Input a monoscope signal.
2. Activate the Service Adjustment Mode.
3. Set the PICTURE and BRIGHTNESS to minimum.
4. Select the SBRT item with **[1]** and **[4]**.
5. Adjust the values of SBRT with **[3]** and **[6]** to obtain a faintly visible crosshatch.
6. Press **[MUTING]** then **[ENTER]** to save into the memory.

Sub Hue, Sub Color Adjustment (SHUE, SCOL)

1. Input color-bar signal at 75%.
2. Activate the Service Adjustment Mode.
3. Set (PIC) to Max and (COL) to 50%.
4. Connect an oscilloscope probe to CV Board, CN301Pin ④ Blue Out.
5. Select the SHUE and SCOL item with **[1]** and **[4]**.
6. While showing the SHUE item, adjust the waveform with **[3]** and **[6]** until the second and third bars show the same level ($V_2 = V_3 < 0.15V_{p-p}$). Set Sub Hue -2 Step.
7. While showing the SCOL item, adjust the waveform with **[3]** and **[6]** until the first and fourth bars show the same level ($V_1 = V_4 < 0.15V_{p-p}$). Set Sub Col +3 Step.

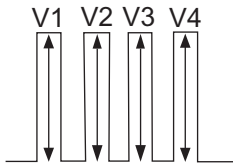

8. Press **[MUTING]** then **[ENTER]** to save into the memory.

V. Size Adjustment (VSIZ)

1. Input a crosshatch signal.
2. Activate the Service Adjustment Mode.
3. Select the VSIZ item with **[1]** and **[4]**.
4. Adjust value of VPOS with **[1]** and **[4]** for the best vertical center.
5. Press **[MUTING]** then **[ENTER]** to save into the memory.

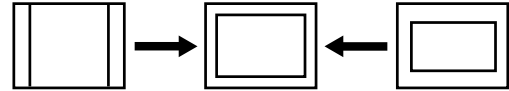

V. Center Adjustment (VPOS)

Perform this adjustment after performing H. Frequency (Free Run) Check.

1. Input a crosshatch signal.
2. Activate the Service Adjustment Mode.
3. Select the VPOS item with **[1]** and **[4]**.
4. Adjust value of VPOS with **[3]** and **[6]** for the best vertical center.
5. Press **[MUTING]** then **[ENTER]** to save into the memory.

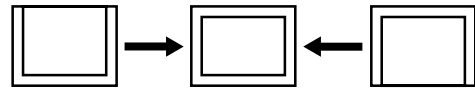

H. Center Adjustment (HPOS)

Perform this adjustment after performing H. Frequency (Free Run) Check.

1. Input a crosshatch signal.
2. Activate the Service Adjustment Mode.
3. Select the HPOS item with **[1]** and **[4]**.
4. Adjust the value of HPOS with **[3]** and **[6]** for the best horizontal center.
5. Press **[MUTING]** then **[ENTER]** to save into the memory.

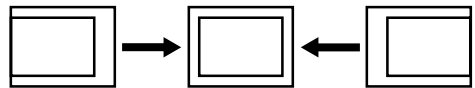

H. Size Adjustment (HSIZ)

1. Input a monoscope signal.
2. Activate the Service Adjustment Mode.
3. Select HSIZ with **1** and **4**.
4. Adjust with **3** and **6** for the best horizontal size.
5. Press **MUTING** then **ENTER** to save into the memory.



V. Linearity (VLIN), V. Correction (SCOR), PIN Amp (PAMP), and Horizontal Trapezoid (HTRP) Adjustments

1. Input a crosshatch signal.
2. Activate the Service Adjustment Mode.
3. Select VLIN, SCOR, PAMP, and HTRP with **1** and **4**.
4. Adjust with **3** and **6** for the best horizontal size.
5. Press **MUTING** then **ENTER** to save into the memory.

V LINEARITY (VLIN)

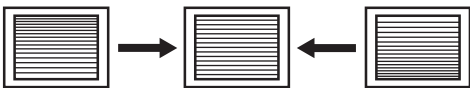

V CORRECTION (SCOR)

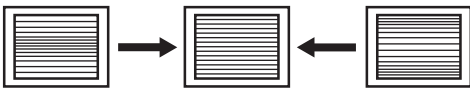

PIN AMP (PAMP)



HORIZONTAL TRAPEZOID (HTRP)

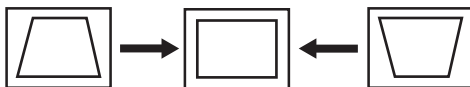

V. Angle (VANG), V. Bow (VBOW), Upper PIN (UPIN) and Low PIN (LPIN) Adjustments

1. Input a crosshatch signal.
2. Activate the Service Adjustment Mode.
3. Select VANG, VBOW, UPIN, and LPIN with **1** and **4**.
4. Adjust with **3** and **6** for the best picture.
5. Press **MUTING** then **ENTER** to save into the memory.

V ANGLE (VANG)

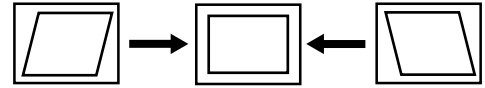

V BOW (VBOW)

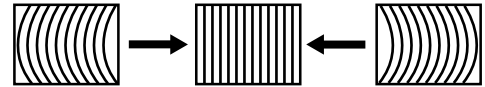

UPPER PIN (UPIN)

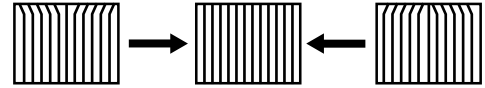

LOW PIN (LPIN)

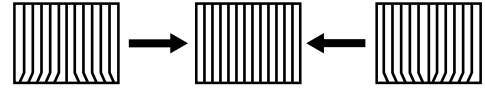

Service Adjustment Mode Memory

1. After completing all adjustments, press **0** then **ENTER**.

Read From Memory

Signal Type	Mode	Category	Display Item	Item Data	
	service	defl	vbow	7	Green 0
	vchp	00000000	00000000		Red ENTER

SECTION 5: DIAGRAMS

5-1. CIRCUIT BOARDS LOCATION

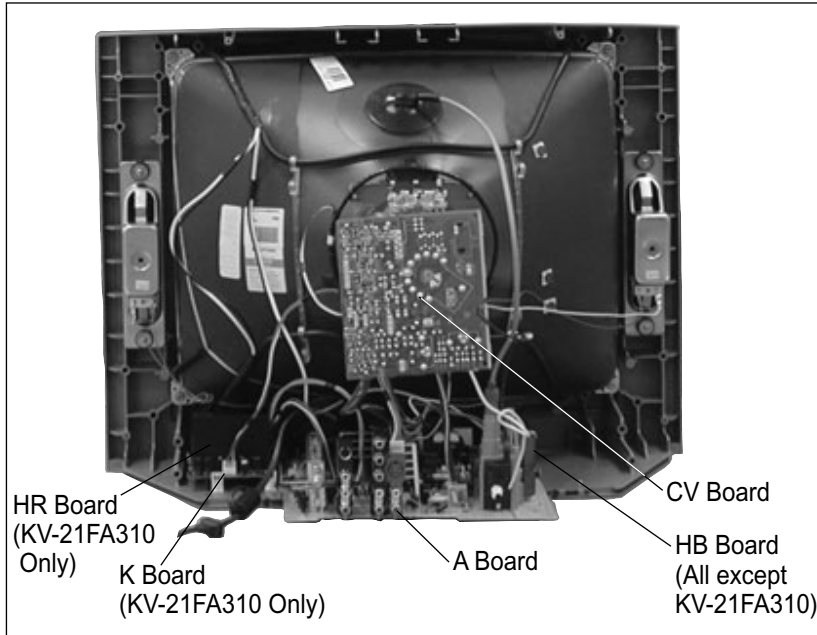

The components identified by shading and \triangle symbol are critical for safety. Replace only with part number specified.

The symbol \blacksquare indicates a fast operating fuse and is displayed on the component side of the board. Replace only with fuse of the same rating as marked.

Les composants identifiés par un trame et une marque \triangle sont critiques pour la sécurité. Ne les remplacer que par une pièce portant le numéro spécifié.

Le symbole \blacksquare indique une fusible à action rapide. Doit être remplacé par une fusible de même valeur, comme marqué.

The components identified by \blacksquare in this basic schematic diagram have been carefully factory-selected for each set in order to satisfy regulations regarding X-ray radiation. Should replacement be necessary, replace only with the value originally used.

5-2. PRINTED WIRING BOARD AND SCHEMATIC DIAGRAM INFORMATION

All capacitors are in μF unless otherwise noted. pF : μF 50WV or less are not indicated except for electrolytics and tantalums.

All electrolytics are in 50V unless otherwise specified.

All resistors are in ohms. k=1000, M=1000k

Indication of resistance, which does not have one for rating electrical power, is as follows: Pitch : 5mm Rating electrical power :

$\frac{1}{4}$ W in resistance, $\frac{1}{10}$ W and $\frac{1}{8}$ W in chip resistance.

$\text{---}\square\text{---}$: nonflammable resistor.

$\text{---}\square\text{---}$: fusible resistor.

\triangle : internal component.

\square : panel designation and adjustment for repair.

\perp : earth ground

$\text{---}\text{---}$: earth-chassis

All variable and adjustable resistors have characteristic curve B, unless otherwise noted.

Readings are taken with a color-bar signal input.

Readings are taken with a 10M digital multimeter.

Voltages are DC with respect to ground unless otherwise noted.

Voltage variations may be noted due to normal production tolerances.

All voltages are in V.

S : Measurement impossibility.

$\text{---}\square\text{---}$: B-line. (Actual measured value may be different).

$\text{---}\rightarrow\text{---}$: signal path. (RF)

Circled numbers are waveform references.

When replacing components identified by \blacksquare , make the necessary adjustments as indicated. If the results do not meet the specified value, change the component identified by \blacksquare and repeat the adjustment until the specified value is achieved.

(Refer to Section 3: Safety Related Adjustments on Page 17.)

When replacing the parts listed in the table below, it is important to perform the related adjustments.

Part Replaced (\blacksquare)	Adjustment (\blacksquare)
DY, T585, CRT, IC001, IC561, IC600, C506, C507, C508, T511, L510, C588, L588, C566, C561, C563, D567, D568, D566, PH602, R567, R568, R565, R566, R562, R563, R561, R528.....A Board	HV HOLD-DOWN RV565

REFERENCE INFORMATION

RESISTOR

: RN METAL FILM
: RC SOLID
: FPRD NONFLAMMABLE CARBON
: FUSE NONFLAMMABLE FUSIBLE
: RW NONFLAMMABLE WIREWOUND
: RS NONFLAMMABLE METAL OXIDE
: RB NONFLAMMABLE CEMENT
: \otimes ADJUSTMENT RESISTOR

CAPACITOR

: TA TANTALUM
: PS STYROL
: PP POLYPROPYLENE
: PT MYLAR
: MPS METALIZED POLYESTER
: MPP METALIZED POLYPROPYLENE
: ALB BIPOLAR
: ALT HIGH TEMPERATURE
: ALR HIGH RIPPLE

COIL

: LF-8L MICRO INDUCTOR

A BOARD SCHEMATIC DIAGRAM

KV2P5102P1W102P5102P1A102P5102P510

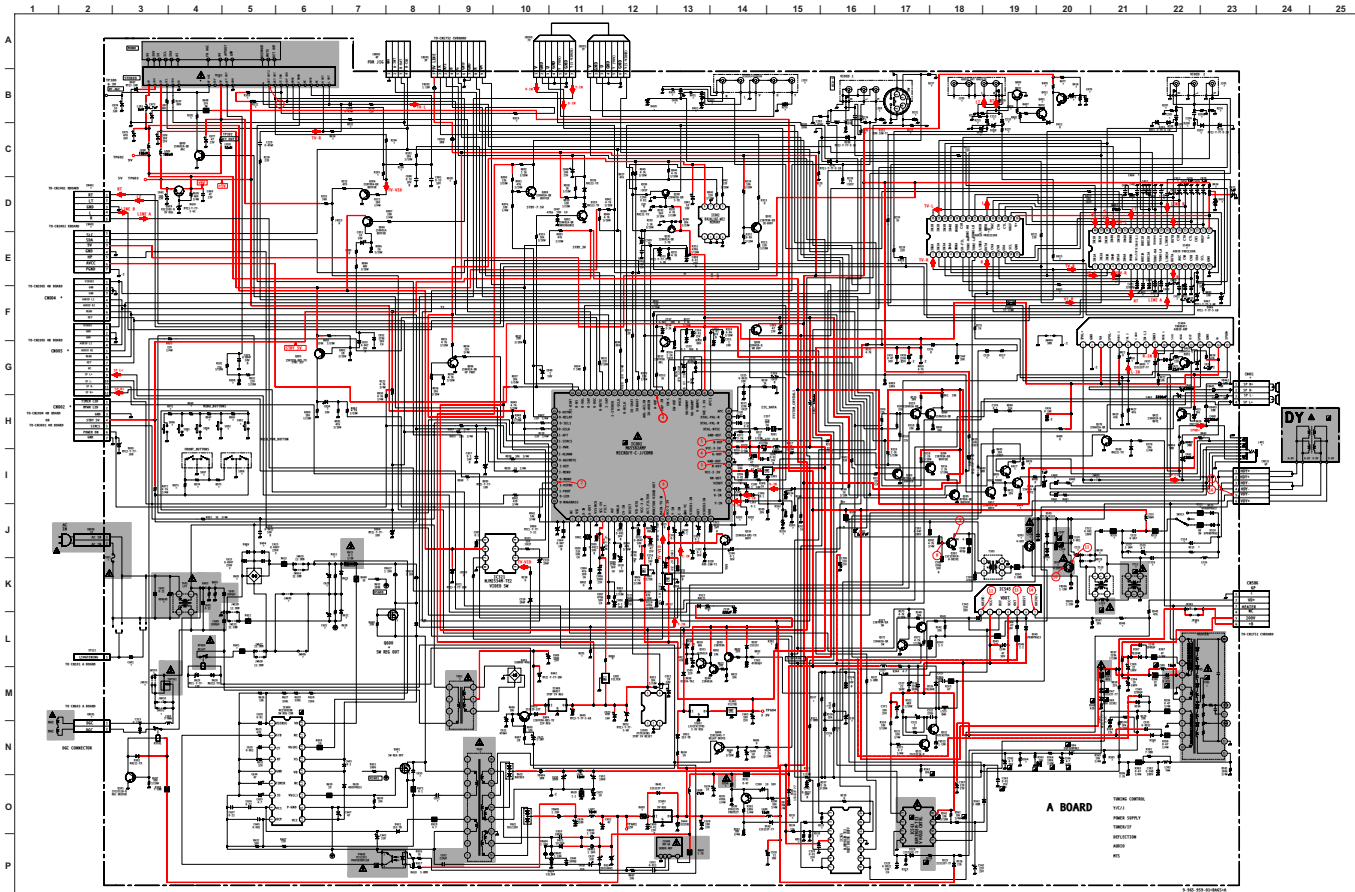

A BOARD WAVEFORMS

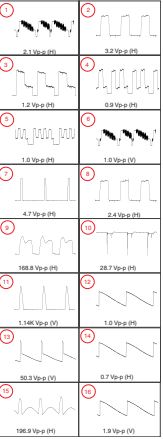

KV2P5102P1W102P5102P1A102P5102P510

A TUNING CONTROL, V.C. JANGLE, POWER SUPPLY, TUNING, DEFLECTION, AUDIO, MTR
COMPONENT SIDE

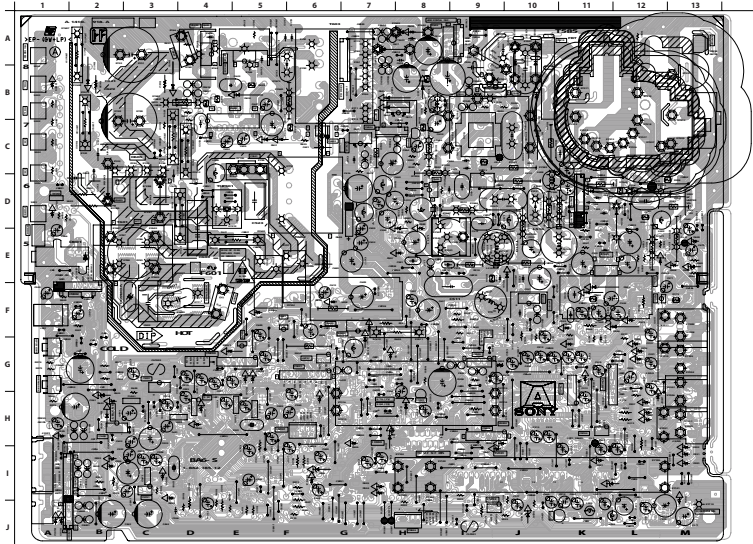

A BOARD LOCATOR LIST CONDUCTOR SIDE

DOGEE	DOGEE	DOGEE	IC	TRANSISTORS					
D002	B3	D317	B11	D563	D11	IC601	B4	D561	C7
D003	C1	D361	B1	D567	F12	IC605	B5	D427	D11
D004	C1	D361	C8	D567	F12	IC605	B5	D427	D11
D005	A3	D390	D8	D568	F13	IC621	B11	D493	A7
D006	B6	D401	C8	D569	F13	IC630	C10	D404	C8
D007	B11	D435	B7	D567	G11	IC401	C10	D411	C7
D008	C7	D413	A12	D569	F8	IC604	B9	D412	A12
D046	B9	D414	A13	D569	G12	IC645	F11	D420	B7
D047	B9	D430	B6	D569	G12	IC661	E12	D421	B6
D050	B2	D430	D13	D563	F7	IC605	F9	D552	C6
D051	D4	D431	D12	D564	G3	IC600	H6	D552	C8
D052	B5	D432	D9	D565	G3	IC603	I2	D553	F7
D050	C12	D509	G7	D565	G3	IC604	IS	D554	F8
D051	B13	D509	E6	D511	B8	IC606	B2	D555	B9
D052	A1	D555	I10	D512	I2	IC633	C3	D556	I10
D053	A1	D556	I9	D513	I4	TRANSISTORS	D519	C7	
D054	B12	D567	F8	D514	I8	D502	B3	D521	E12
D055	C12	D568	D11	D515	I7	D504	A12	D522	E19
D056	A11	D568	I10	D516	I6	D505	A12	D523	F7
D057	A11	D519	F7	D520	E6	D506	D1	D523	C7
D058	D12	D514	H6	D521	I7	D508	D1	D572	D7
D059	A1	D515	H10	D524	B8	D509	B11	D572	D6
D030	C1	D525	D11	D528	E5	D530	D6	D578	D11
D031	B13	D528	E12	D529	E5	IC601	C3	D580	H6
D032	B13	D528	E12	D531	H6	IC603	C6	D580	I4
D034	D6	D545	E11	D541	G7	IC604	D6	D571	I5
D035	C12	D558	D8	D542	C2	IC605	C3	D580	I8
D036	D5	D559	C7	D544	D7	IC606	B9	D580	D5
D037	C12	D562	F8	D545	C2	IC616	C3	D582	A13
				D550	B10	IC630	D7	D580	C7

KV-20F9102FPW-0202F9102FA1020F910202F910

A BOARD IC VOLTAGE LIST

IC601	31	2.0	6.0	1.4	IC621	20	3.9	17	4.5	IC645	IC660	IC668						
PIN	VOLT	32	GND	6.6	4.9	PIN	VOLT	20	3.9	18	3.9	PIN	VOLT	PIN	VOLT			
1	NC	33	2.8	6.6	4.9	1	4.5	20	0.6	10	3.9	1	0.7	1	2.5	11.0		
2	GND	34	2.1	6.6	0.0	2	4.5	21	4.5	20	4.5	2	1.3	2	0	9.5		
3	2.2	35	2.0	6.7	0.1	3	4.5	28	4.5	21	4.5	3	12.2	3	2.2	G	IC631	
4	2.2	36	GND	6.6	0.1	4	0.4	29	4.5	22	NC	4	13.1	4	2.5	IC633		
5	GND	37	1.8	6.6	2.4	5	4.3	30	4.5	23	4.5	5	0.2	5	GND	PIN	VOLT	
6	4.5	38	0.1	7.0	5.0	6	4.1	31	4.5	24	4.5	6	1.8	6	0.7	7	4.7	2.1
7	0.0	39	0.1	7.0	5.0	7	4.4	32	4.5	25	4.5	7	0.7	7	0.0	G	GND	
8	2.0	40	2.0	7.0	0.1	8	GND	33	4.5	26	NC	IC635	8	17.2	0	3.3		
9	0.3	41	1.6	7.0	0.0	9	IC669	36	NC	27	4.5	9	GND	9	GND			
10	2.1	42	3.3	7.0	5.0	10	PIN	VOLT	38	NC	28	4.5	1	0.1	10	10.4		
11	5.0	43	NC	7.0	5.0	11	4.5	38	NC	29	4.5	3	3.4	11	0.1			
12	GND	44	1.6	7.0	5.0	12	4.5	37	4.5	30	4.5	3	2.3	12	4.8			
13	3.3	45	1.6	7.0	0.1	13	4.5	36	4.5	IC664	4	GND	13	NC				
14	3.1	46	2.3	7.0	0.0	14	4.5	35	4.5	PIN	VOLT	5	10.2	14	10.1			
15	1.0	47	1.0	7.0	4.9	15	NC	40	4.5	1	8.3	8	10.2	15	103.5			
16	1.6	48	NC	6.0	4.9	16	NC	41	4.5	2	GND	7	0.1	16	107.6			
17	3.3	49	0.3	IC602	7	NC	IC601	3	19.8	8	13.0	17	NC					
18	0.5	50	1.7	PIN	VOLT	8	4.1	1	4.5	4	8.7	IC637	18	20.0				
19	1.1	51	2.0	GND	9	4.5	2	4.5	5	10.6	PIN	VOLT	IC663					
20	GND	52	1.5	2	GND	10	4.5	3	4.5	6	3.2	1	3.4	PIN	VOLT			
21	0.5	53	4.8	3	GND	11	4.5	4	4.5	7	0.0	2	3.4	3	13.2			
22	1.7	54	4.8	4	GND	12	4.5	5	NC	8	0.0	3	2.1	5	GND			
23	0.5	55	4.8	5	4.8	13	4.5	6	4.5	9	3.2	4	9.0	0	9.1			
24	0.5	56	4.8	6	4.8	14	4.5	7	4.5	10	0.1	5	1.0	IC664				
25	0.5	57	NC	7	GND	15	0.0	8	4.5	11	0.1	6	9.0	PIN	VOLT			
26	0.5	58	0.0	IC660	17	3.5	10	4.5	13	3.3	8	1.6	2	NC				
27	0.0	59	0.0	IC660	17	3.5	10	4.5	13	3.3	8	1.6	2	NC				
28	2.1	60	0.0	PIN	VOLT	18	4.8	11	3.5	14	8.3	9	1.6	3	1.5			
29	2.7	61	0.0	1	NC	19	4.8	12	3.5	15	GND	10	1.6	4	11.3			
30	3.3	62	0.0	2	GND	20	4.8	13	3.5	16	GND	11	1.6	5	GND			
				3	GND	21	9	14	4.8	17	0.3	12	1.6					
				4	5.0	22	4.5	15	GND	18	1.6							
				5	5.0	23	3.8	16	0.0	19	1.6							

A BOARD TRANSISTOR VOLTAGE LIST

Q002	B	C	E	Q061	B	C	E
Q002	0.0	2.0	GND	Q061	0.0	14.3	GND
Q004	3.8	0.0	2.1	Q062	0.0	14.3	GND
Q005	0.1	0.8	5.0	Q063	2.9	0.0	5.0
Q006	0.0	0.0	GND	Q064	0.0	0.0	GND
Q008	0.0	2.6	GND	Q065	0.0	131.8	0.0
Q009	0.0	4.2	GND	Q066	0.0	131.8	0.0
Q080	1.8	0.0	2.1	Q069	0.0	3.8	GND
Q081	3.8	2.1	3.6	Q071	0.0	3.8	GND
Q083	3.6	GND	2.8	Q072	0.1	2.1	0.0
Q084	3.6	GND	2.8	Q073	0.0	0.0	GND
Q085	3.6	GND	3.0	Q074	1.5	GND	1.5
Q086	0.5	GND	4.0	Q075	0.0	2.6	GND
Q088	0.0	3.3	5.0	Q076	2.6	0.0	2.6
Q089	0.8	1.5	1.9	Q078	0.0	0.5	GND
Q091	0.8	3.5	1.6	Q080	133.1	0.0	134.2
Q400	0.0	0.1	GND	Q084	30.6	11.6	30.2
Q401	0.0	0.1	GND	Q088	0.0	8.7	GND
Q402	0.0	0.7	0.0	Q089	0.8	0.0	5.0
Q404	0.0	0.0	GND	Q089	3.9	5.7	3.3
Q411	0.0	1.6	GND				
Q412	0.1	0.1	GND				

A TUNING CONTROL, V.C. JANGLE, POWER SUPPLY, TUNING, DEFLECTION, AUDIO, MTR
CONDUCTOR SIDE

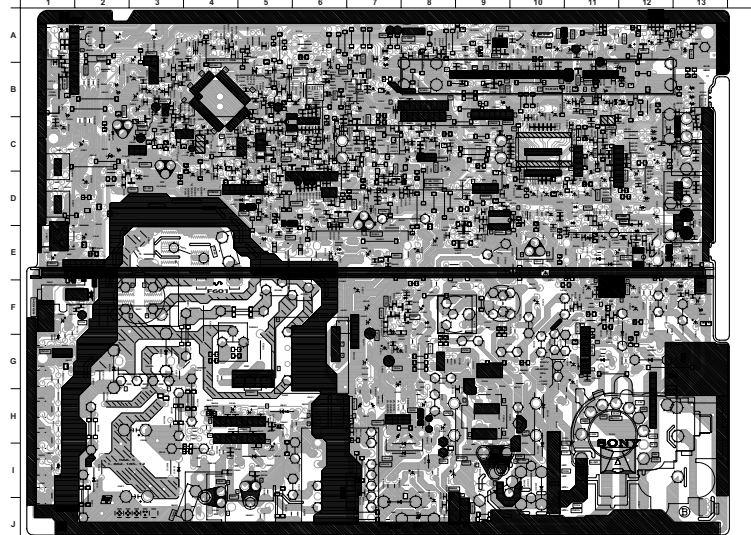

HB BOARD SCHEMATIC DIAGRAM (ALL EXCEPT KV-21FA310)

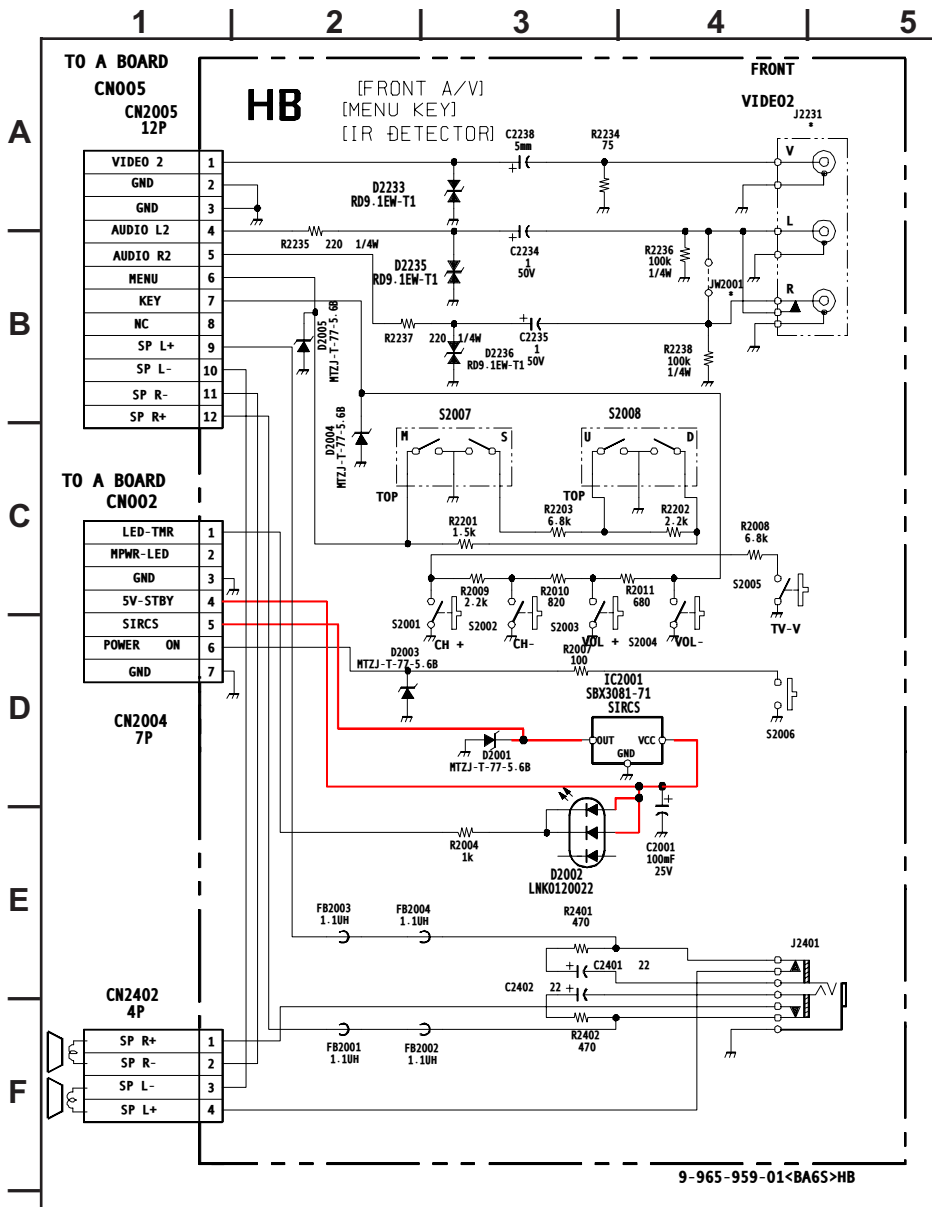



[FRONT AV, MENU KEY, IR DETECTOR]

COMPONENT SIDE (ALL EXCEPT KV-21FA310)

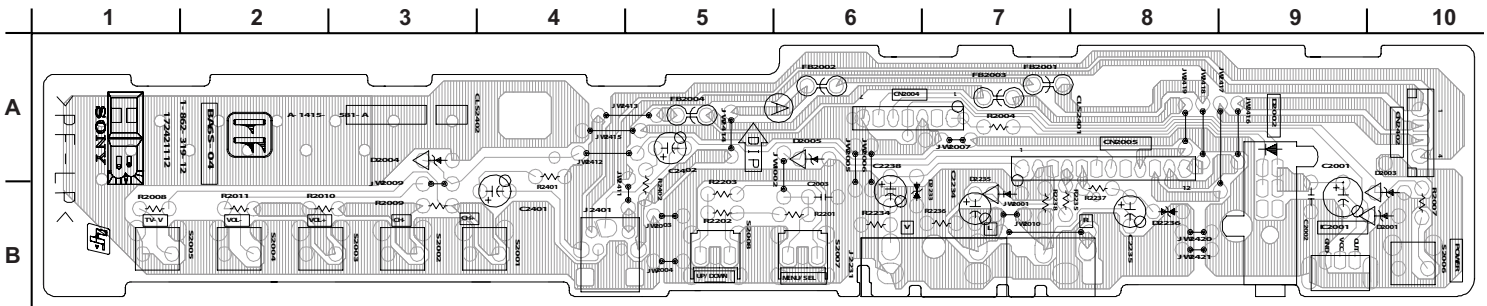

HR BOARD SCHEMATIC DIAGRAM (KV-21FA310 ONLY)

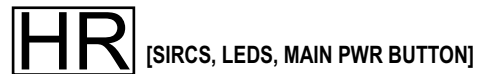
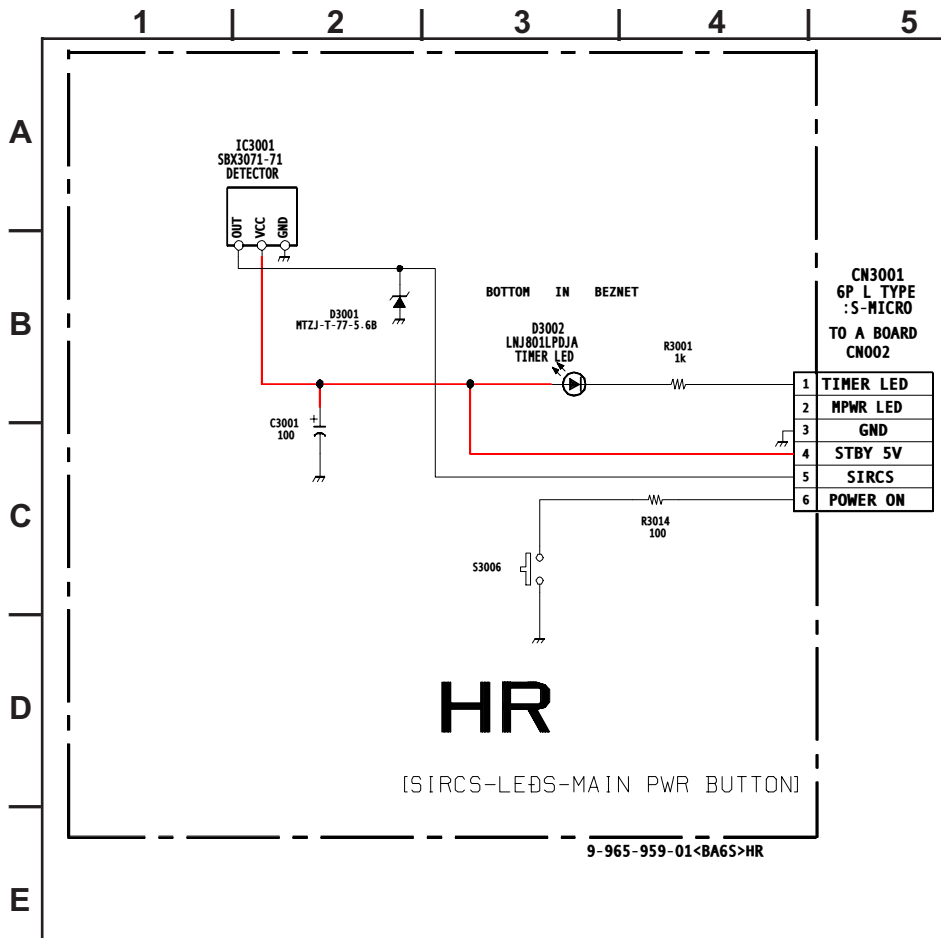

COMPONENT SIDE (KV-21FA310 ONLY)

CONDUCTOR SIDE (KV-21FA310 ONLY)

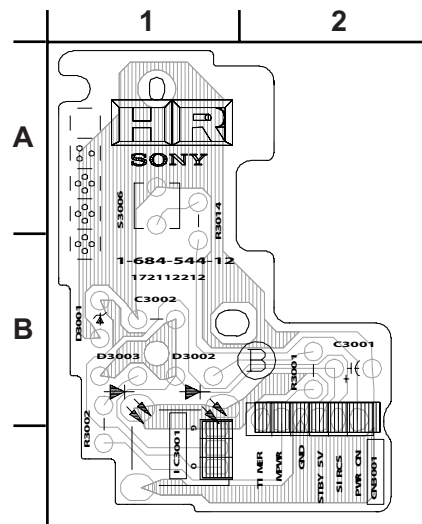
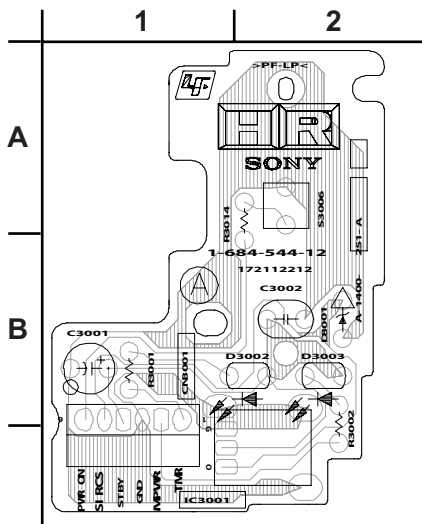

CV BOARD SCHEMATIC DIAGRAM

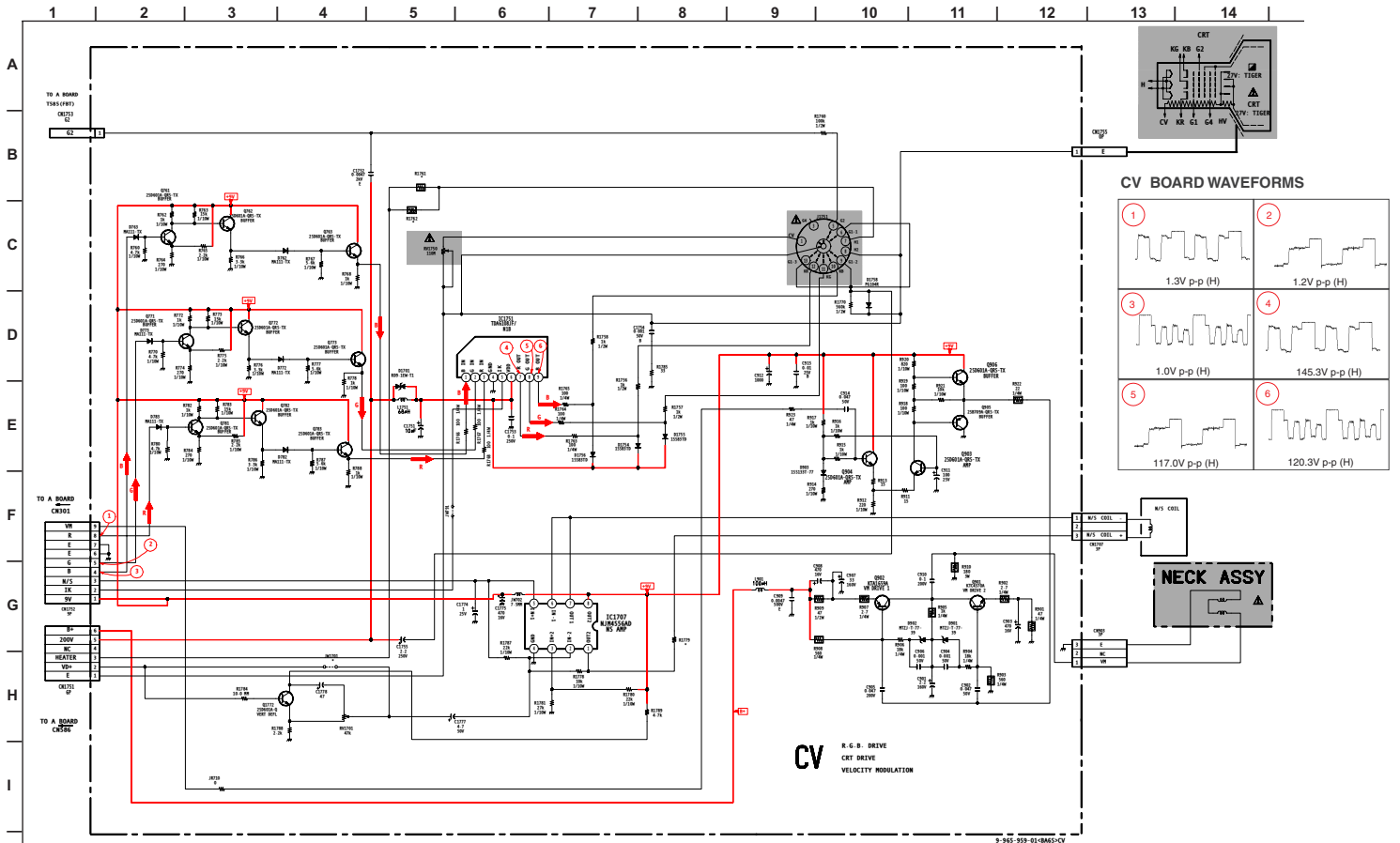

9-951-959-01-0M55-CV

CV BOARD IC VOLTAGE LIST

IC701		IC1751	
PIN	VOLT	PIN	VOLT
1	1.8	1	2.0
2	2.8	2	2.0
3	4.4	3	2.4
4	GND	4	GND
5	4.8	5	3.7
6	4.8	6	200.0
7	4.8	7	136.0
8	9.0	8	142.0
		9	140.0

All voltages are in V.

CV BOARD TRANSISTOR LIST

	B	C	E		B	C	E
Q761	2.2	3.8	2.9	Q783	2.1	9.0	2.7
Q762	3.1	9.0	3.8	Q901	0.9	67.0	0.4
Q763	2.0	9.0	2.6	Q902	134.0	67.0	134.0
Q771	2.2	3.8	2.9	Q903	1.8	5.4	2.4
Q772	3.2	9.0	3.8	Q904	1.8	9.0	2.4
Q773	2.0	9.0	2.6	Q905	5.7	GND	5.4
Q781	2.2	3.9	2.9	Q906	5.7	9.0	6.1
Q782	3.3	9.0	3.9	Q1772	0.0	0.0	0.0

All voltages are in V.



[RGB DRIVE, CRT DRIVE, VELOCITY MODULATION]

CONDUCTOR SIDE

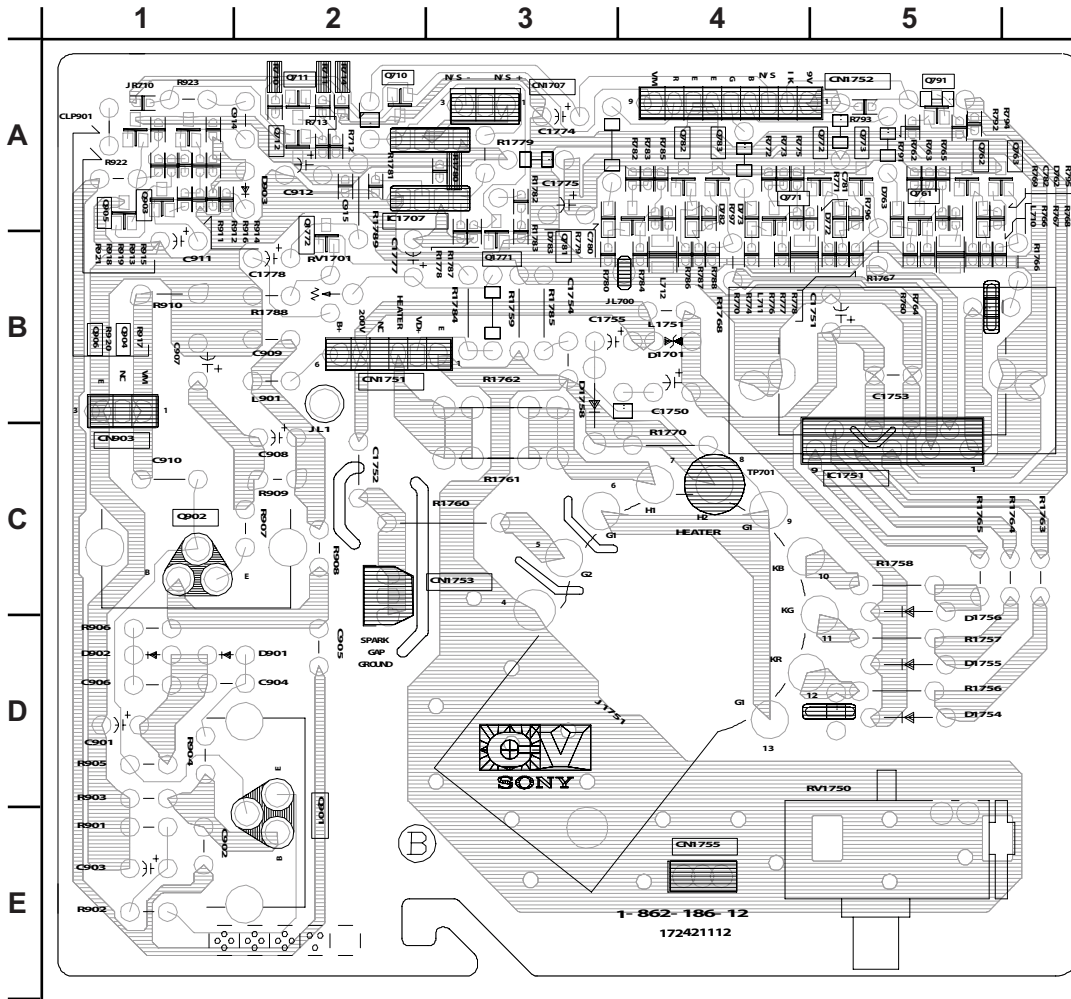

K BOARD SCHEMATIC DIAGRAM (KV-21FA310 ONLY)

KV-20FS120/21FM120/21FS120/21FA310/24FS120/25FS120

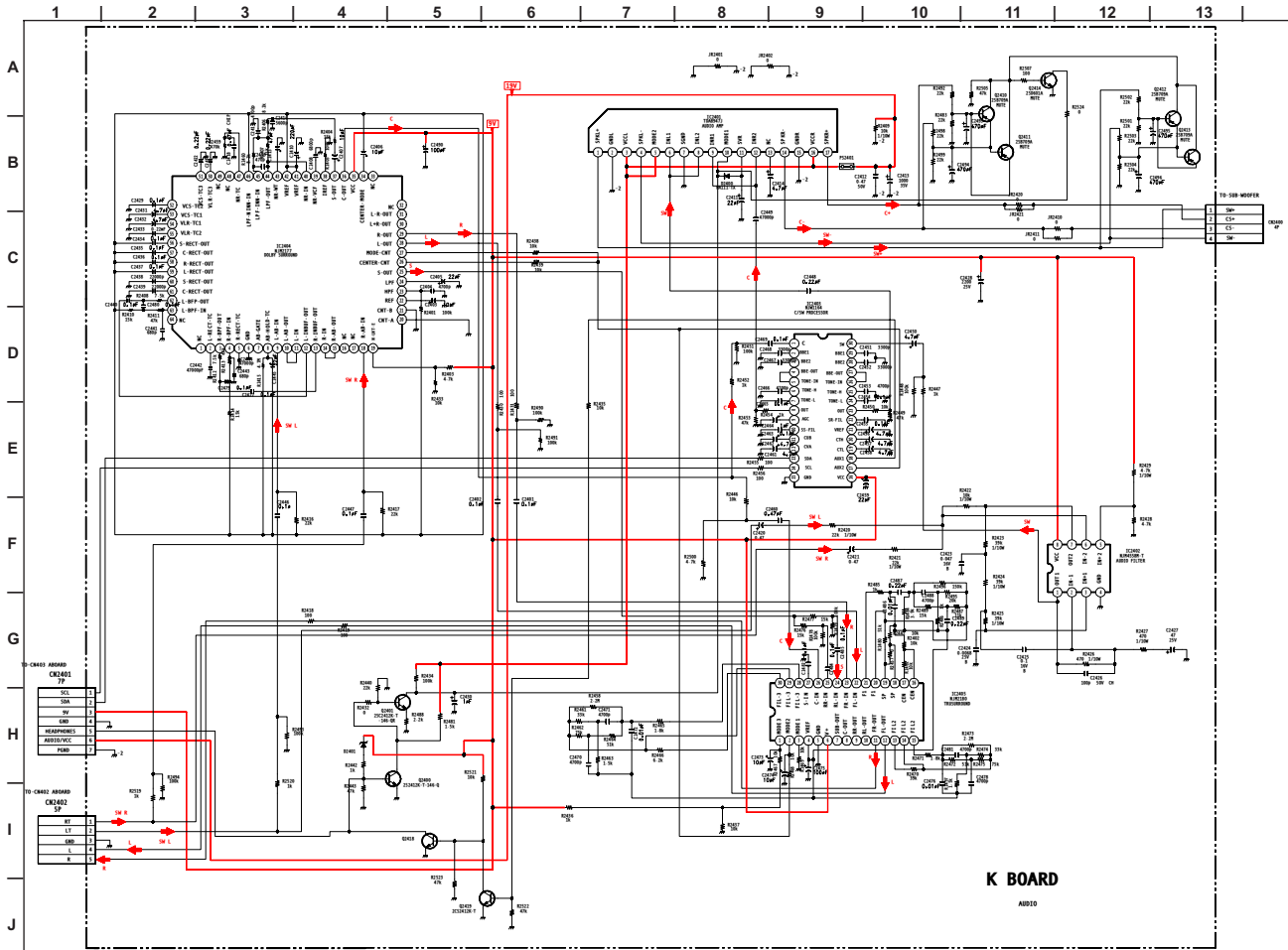

KV-20FS120/21FM120/21FS120/21FA310/24FS120/25FS120

9-965-959-01-08A55-K

K BOARD IC VOLTAGE LIST

IC2401		IC2403		28	4.5	25	4.0	54	4.0	17	4.5
PIN	VOLT	PIN	VOLT	29	4.5	26	4.0	55	4.0	18	4.5
1	8.3	1	4.5	30	4.5	27	4.37	56	4.0	19	4.5
2	GND	2	4.5	IC2404		28	4.0	57	4.0	20	4.5
3	19.6	3	4.5	PIN	VOLT	29	4.0	58	4.0	21	4.5
4	8.3	4	4.5	1	n/c	30	n/c	59	4.0	22	4.5
5	19.6	5	4.5	2	4.0	31	n/c	60	4.0	23	4.5
6	3.2	6	4.5	3	4.0	32	n/c	61	4.0	24	4.5
7	GND	7	4.5	4	4.0	33	n/c	62	4.0	25	4.5
8	0.0	8	4.5	5	4.0	34	4.0	63	4.0	26	4.5
9	3.2	9	1.0	6	GND	35	9.0	64	n/c	27	4.5
10	9.1	10	4.5	7	n/c	36	4.0	IC2405		28	4.5
11	9.7	11	3.4	8	3.8	37	4.0	PIN	VOLT	29	4.5
12	3.2	12	3.3	9	4.0	38	1.45	1	7.7	30	4.5
13	3.3	13	4.5	10	4.0	39	4.0	2	4.6	All voltages are in V.	
14	8.3	14	4.5	11	4.0	40	4.0	3	0.0		
15	GND	15	GND	12	4.0	41	4.0	4	4.5		
16	19.6	16	9.0	13	4.0	42	4.0	5	0.0		
17	8.3	17	4.9	14	4.0	43	4.0	6	9.0		
IC2402		18	0.0	15	4.0	44	4.0	7	n/c		
PIN	VOLT	19	3.88	16	n/c	45	4.0	8	n/c		
1	4.5	20	3.88	17	n/c	46	4.0	9	n/c		
2	4.5	21	4.5	18	4.0	47	0.0	10	n/c		
3	4.5	22	4.5	19	5.8	48	n/c	11	4.5		
4	GND	23	4.5	20	GND	49	n/c	12	4.5		
5	4.5	24	4.5	21	GND	50	4.0	13	4.5		
6	4.5	25	4.5	22	4.0	51	3.0	14	4.5		
7	4.5	26	4.5	23	2.65	52	3.0	15	4.5		
8	9.0	27	4.5	24	4.0	53	3.0	16	4.5		

K BOARD TRANSISTOR LIST

	B	C	E
Q2400	0.7	0.0	GND
Q2401	0.0	17.9	0.0
Q2410	4.8	0.0	4.8
Q2411	4.8	0.0	4.8
Q2412	4.8	0.0	4.9
Q2413	4.8	0.0	4.9
Q2414	0.0	0.2	GND
Q2418	0.0	0.7	GND
Q2419	0.0	0.0	GND

All voltages are in V.



COMPONENT SIDE (KV-21FA310 ONLY)

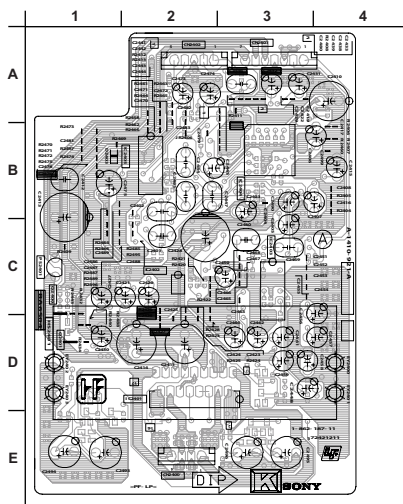

CONDUCTOR SIDE (KV-21FA310 ONLY)

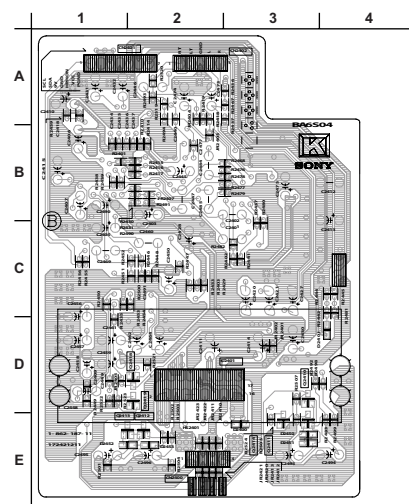

5-4. SEMICONDUCTORS

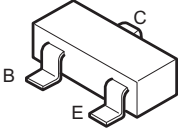
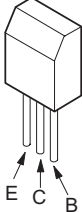
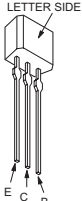
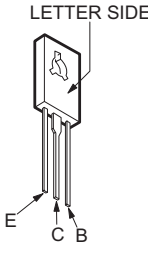
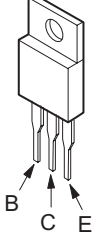
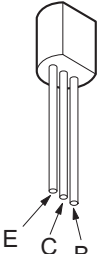
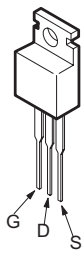
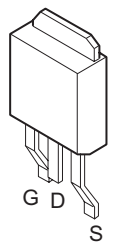
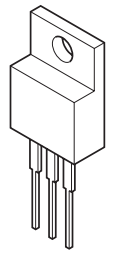
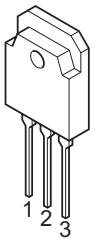
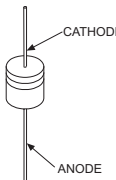
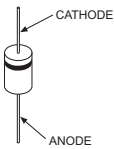
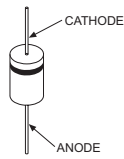
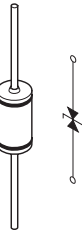
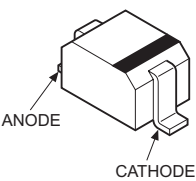
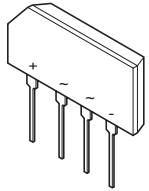
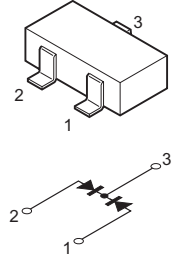
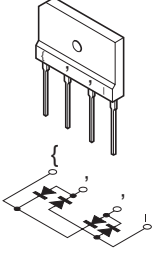
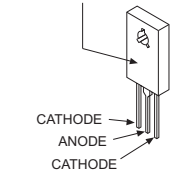
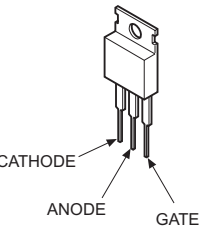
<p>2SB709A-QRS-TX 2SD601A-QRS-TX</p> 	<p>2SB734-T-34 2SC3209LK-TP</p> 	<p>2SA1309A-QRSTA 2SC3311A-QRSTA 2SD2144S-TP-UVV</p> 	<p>2SC3840K</p> 	<p>2SA1837</p> 
<p>2SA10910-TPE2</p> 	<p>IRF614</p> 	<p>2SK2663</p> 	<p>2SC4793</p> 	<p>2SD2578-YB</p> 
<p>ERA38-06TP1 ERA82-004TP5 1SS133T-77 D1NS0R-TA MTZJ-T-77-12C MTZJ-T-77-15B MTZJ-T-77-33B MTZJ-T-77-39</p> 	<p>RU-1P ERC06-15S EGP20DPKG23 MTZJ-T-77-5.1C MTZJ-T-77-5.6C MTZJ-T-77-7.5A MTZJ-T-77-10B MTZJ-T-77-30D RGP10-GPKG3 RGP02-17PKG23 RGP15GPKG23</p> 	<p>ERB44-06TP1 1SS83TD GP08DPKG23 RGP10GPKG23 RU4AM-T3</p> 	<p>RD9.1EW-T1</p> 	<p>MA111-TX UDZ-TE-17.5.1B UDZ-TE-17.91B</p> 
<p>D2SB60A-F04</p> 	<p>DAP202K-T-146</p> 	<p>D4SB60L-F</p> 		
<p>D5LC20U</p> <p>MARKING SIDE VIEW</p> 	<p>TF541M</p> 			

SECTION 6: EXPLODED VIEWS

Components not identified by a part number or description are not stocked because they are seldom required for routine service.

The component parts of an assembly are indicated by the reference numbers in the far right column of the parts list and within the dotted lines of the diagram.

* Items marked with an asterisk are not stocked since they are seldom required for routine service. Expect some delay when ordering these components.

NOTE: The components identified by shading and \triangle mark are critical for safety. Replace only with part number specified.

NOTE: Les composants identifiés par un trame et une marque \triangle sont critiques pour la sécurité. Ne les remplacer que par une pièce portant le numéro spécifié.

6-1. PICTURE TUBE (KV-20FS120/21FS120 ONLY)

- 4-384-096-01 SCREW (4X16), TAPPING, +P
- ▲ 4-365-808-01 SCREW (5), TAPPING

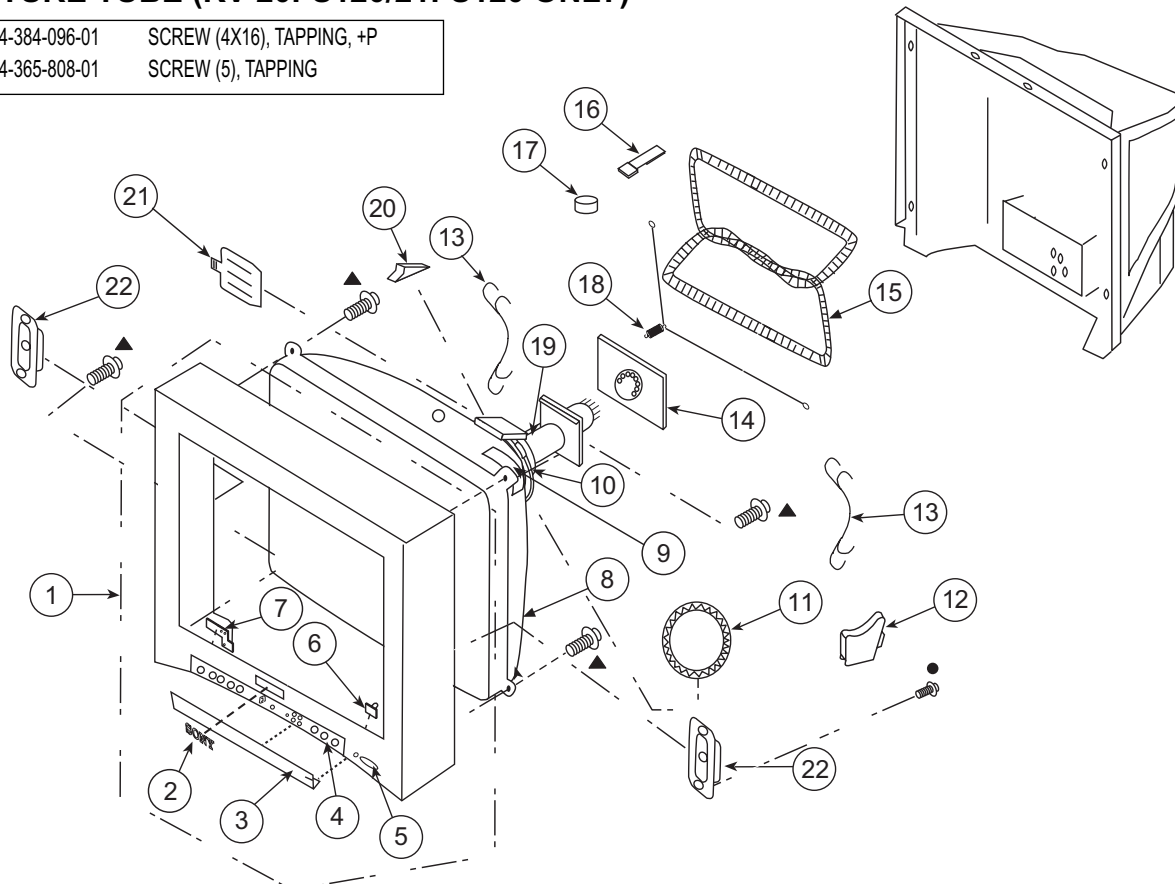

REF. NO.	PART NO.	DESCRIPTION	[ASSEMBLY INCLUDES]	REF. NO.	PART NO.	DESCRIPTION
1	X-4042-988-1	BEZNET ASSY (20) (KV-20FS120 ONLY)	[2-7]	\triangle 11	1-456-285-11	COIL, NA ROTATION (RT-154)
1	X-4042-990-1	BEZNET ASSY (21) (KV-21FS120 ONLY)	[2-7]	12	4-102-537-01	SUPPORT, CRT(20)
2	4-046-161-21	EMBLEM, SONY NO.8		* 13	4-080-810-21	BAND, DEGAUSS COIL
3	4-102-301-11	DOOR		* 14	A-1410-919-A	CV (VAR) BOARD, MOUNTED
4	4-102-307-01	LABEL, DOOR		\triangle 15	1-456-153-11	COIL, DEGAUSSING
5	4-102-305-11	BUTTON, POWER		16	4-083-414-01	PIECE A(110), CONV CORRECT
6	4-102-306-01	GUIDE, LED/IR		17	1-452-032-00	MAGNET, DISC
* 7	4-083-303-01	SPRING, METAL		* 18	4-375-394-01	SPRING, TENSION
\triangle 8	8-738-831-05	CRT 21RSN(SDP) (ALL EXCEPT KV-21FS120 L SOUTH)		\triangle 19	1-451-561-21	NECK ASSEMBLY
\triangle 8	8-738-838-05	CRT 21RSN(SDP)(SOUTH) (KV-21FS120 L SOUTH ONLY)		\triangle 20	4-053-005-01	SPACER, DY
* 9	4-074-576-01	CUSHION, DGC		21	4-057-714-01	PIECE ASSY, TLH CORRECTION
\triangle 10	8-451-505-71	DY Y21RSA-V		22	1-825-831-11	LOUDSPEAKER (15X6.5CM)







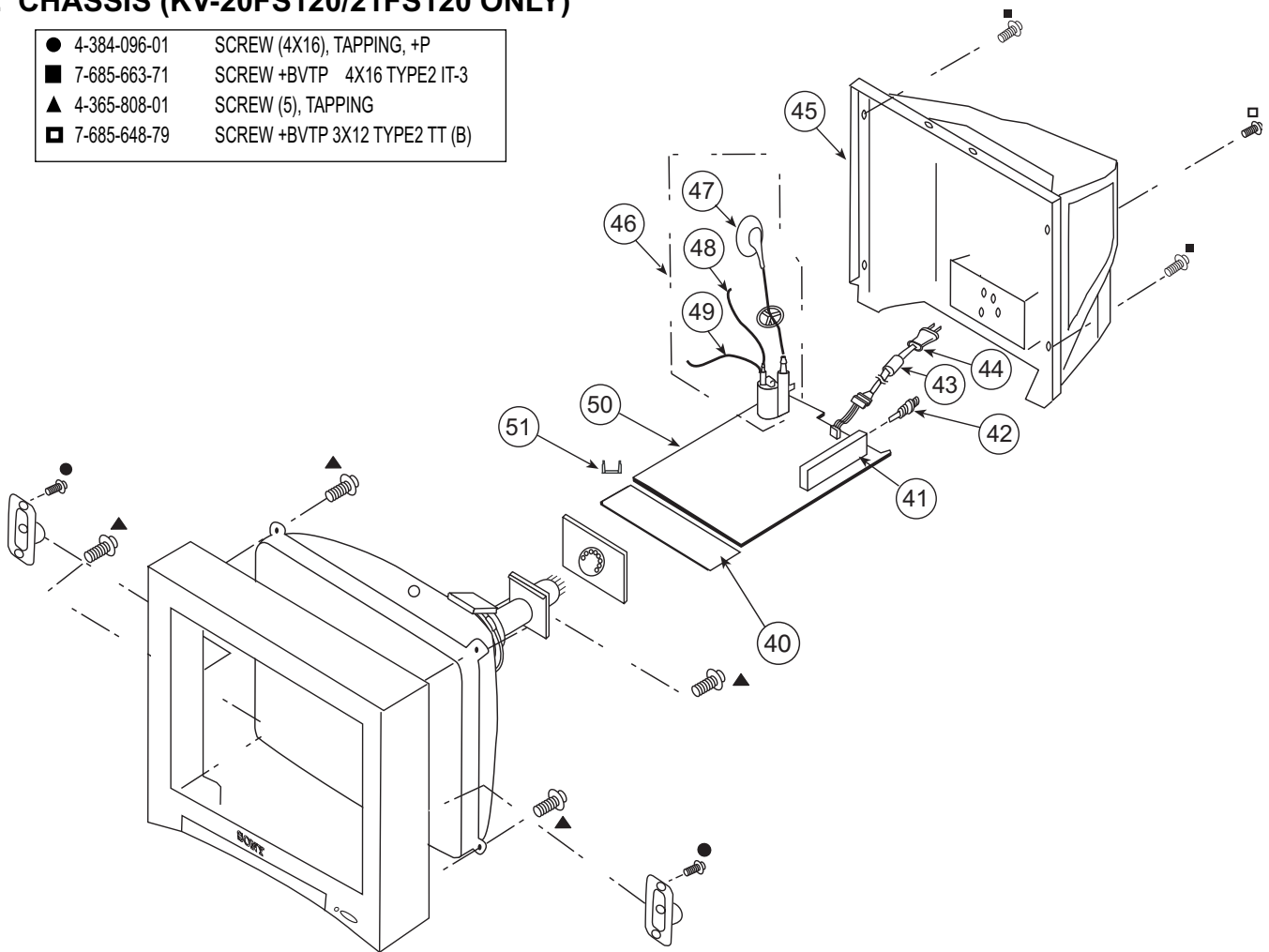

NOTE: The components identified by shading and  mark are critical for safety. Replace only with part number specified.

NOTE: Les composants identifiés par un trame et une marque  sont critiques pour la sécurité. Ne les remplacer que par une pièce portant le numéro spécifié.

6-2. CHASSIS (KV-20FS120/21FS120 ONLY)

- 4-384-096-01 SCREW (4X16), TAPPING, +P
- 7-685-663-71 SCREW +BVTP 4X16 TYPE2 IT-3
- ▲ 4-365-808-01 SCREW (5), TAPPING
- ▣ 7-685-648-79 SCREW +BVTP 3X12 TYPE2 TT (B)



REF. NO.	PART NO.	DESCRIPTION	[ASSEMBLY INCLUDES]	REF. NO.	PART NO.	DESCRIPTION
* 40	A-1415-580-A	HB (VAR) BOARD, MOUNTED		* 50	A-1302-931-A	A BOARD, COMPLETE (KV-20FS120/21FS120 L NORTH ONLY)
 41	8-598-593-50	TUNER, FSS BTF-WA421				The high-voltage leads associated with the FBT on the A board are not included and must be ordered separately. (See 47-49)
 42	1-766-374-11	PLUG, F-PIN		* 50	A-1302-980-A	A BOARD, COMPLETE (KV-21FS120 L SOUTH ONLY)
43	1-500-586-11	FILTER, CLAMP (FERRITE CORE) (KV-21FS120 L SOUTH ONLY)				The high-voltage leads associated with the FBT on the A board are not included and must be ordered separately. (See 47-49)
 44	1-824-069-11	CORD, AC POWER (WITH CONNECTOR) (ALL EXCEPT KV-21FS120 L SOUTH)		* 51	4-076-951-01	HINGE, PWB
 44	1-757-840-12	CORD, POWER (WITH CONNECTOR) (KV-21FS120 L SOUTH ONLY)				
45	4-102-302-01	COVER, REAR				
 46	1-453-316-21	FBT ASSY NX-1748//X4A4	[47-49]			
 47	1-251-642-52	CAP ASSY, HIGH-VOLTAGE				
 48	1-900-800-65	CONNECTOR ASSY, FOCUS LEAD				
 49	1-900-803-22	WIRE ASSY, G2 LEAD				





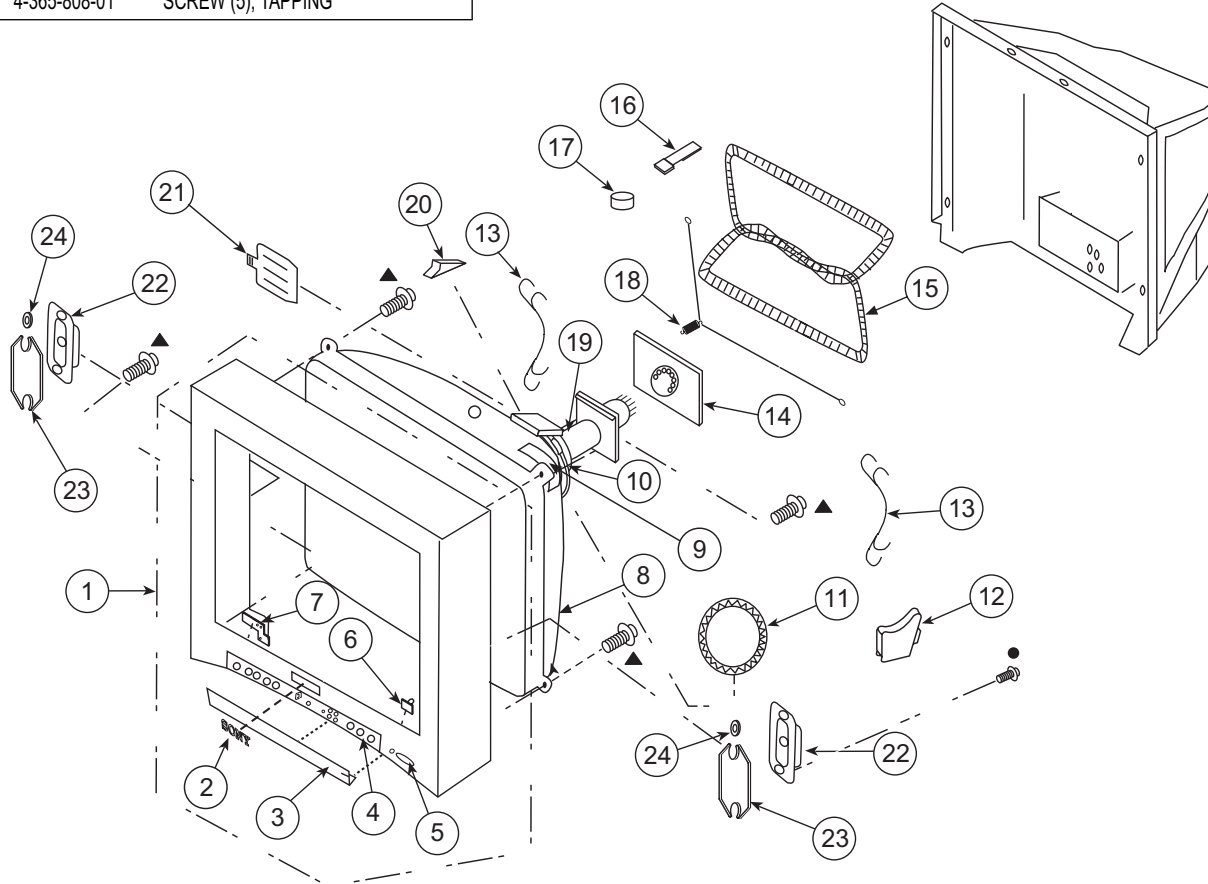

NOTE: The components identified by shading and  mark are critical for safety. Replace only with part number specified.

NOTE: Les composants identifiés par un trame et une marque  sont critiques pour la sécurité. Ne les remplacer que par une pièce portant le numéro spécifié.

6-3. PICTURE TUBE (KV-21FM120 ONLY)

- 4-384-096-01 SCREW (4X16), TAPPING, +P
- ▲ 4-365-808-01 SCREW (5), TAPPING



REF. NO.	PART NO.	DESCRIPTION	[ASSEMBLY INCLUDES]	REF. NO.	PART NO.	DESCRIPTION
* 1	X-4042-989-1	BEZNET ASSY (21)	[2-7]	16	4-083-414-01	PIECE A(110), CONV CORRECT
2	4-046-161-21	EMBLEM, SONY NO.8		17	1-452-032-00	MAGNET, DISC
3	4-102-301-11	DOOR		* 18	4-375-394-01	SPRING, TENSION
4	4-102-307-11	LABEL, DOOR		 19	1-451-561-21	NECK ASSEMBLY
5	4-102-305-11	BUTTON, POWER		 20	4-053-005-01	SPACER, DY
6	4-102-306-01	GUIDE, LED/IR		21	4-057-714-01	PIECE ASSY, TLH CORRECTION
* 7	4-083-303-01	SPRING, METAL		22	1-825-039-11	SPEAKER (15X6.5CM)
 8	8-738-831-05	CRT 21RSN(SDP)		* 23	4-046-981-03	BRACKET, SPEAKER
* 9	4-074-576-01	CUSHION, DGC		* 24	4-374-745-91	CUSHION (A)
 10	8-451-505-71	DY Y21RSA-V				
 11	1-456-285-11	COIL, NA ROTATION (RT-154)				
12	4-102-537-01	SUPPORT, CRT(20)				
* 13	4-080-810-21	BAND, DEGAUSS COIL				
* 14	A-1410-919-A	CV (VAR) BOARD, MOUNTED				
 15	1-456-153-11	COIL, DEGAUSSING				

NOTE: The components identified by shading and \triangle mark are critical for safety. Replace only with part number specified.

NOTE: Les composants identifiés par un trame et une marque \triangle sont critiques pour la sécurité. Ne les remplacer que par une pièce portant le numéro spécifié.

6-4. CHASSIS (KV-21FM120 ONLY)

- 4-384-096-01 SCREW (4X16), TAPPING, +P
- 7-685-663-71 SCREW +BVTP 4X16 TYPE2 IT-3
- ▲ 4-365-808-01 SCREW (5), TAPPING
- ▣ 7-685-648-79 SCREW +BVTP 3X12 TYPE2 TT (B)

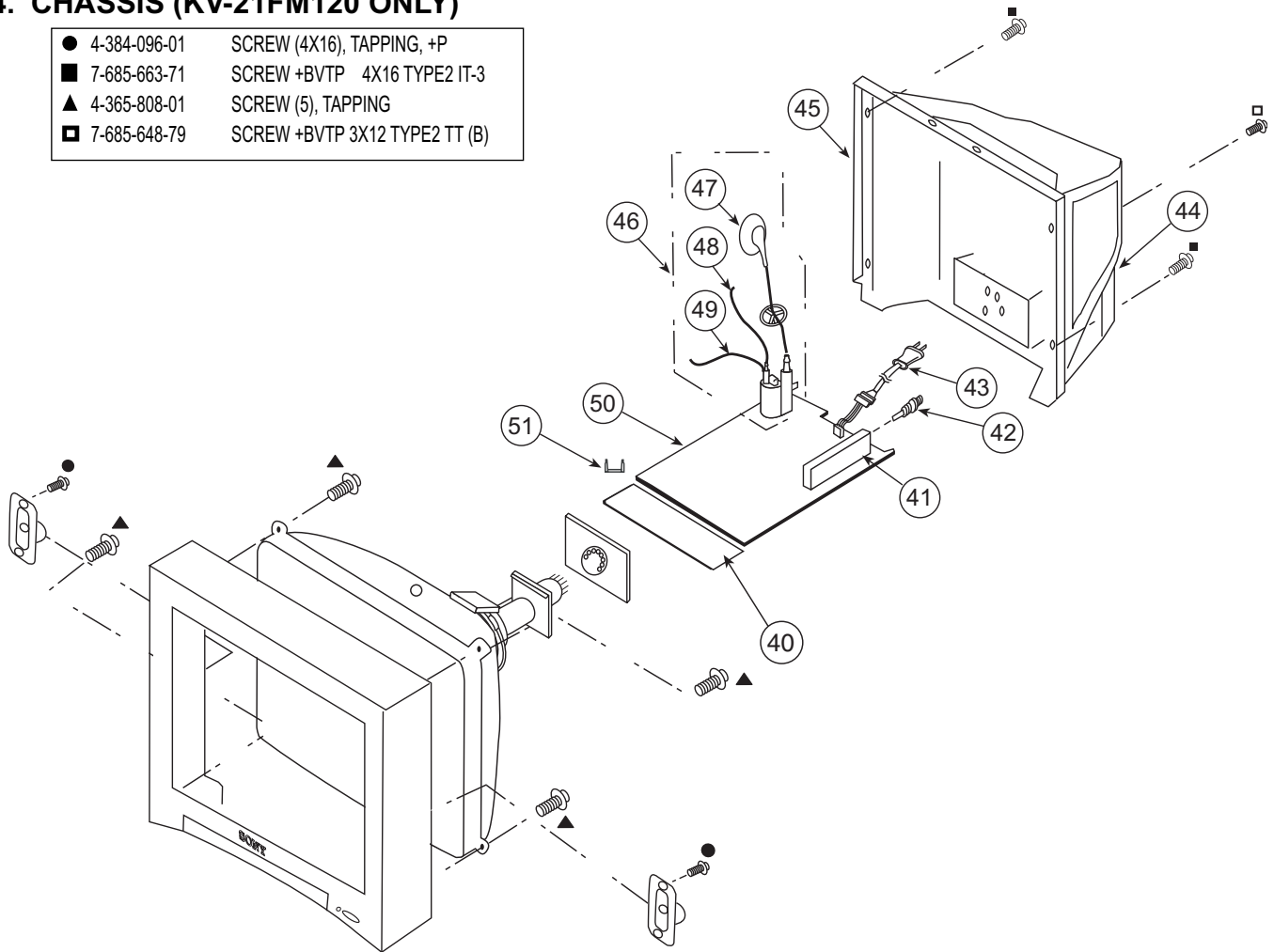

REF. NO.	PART NO.	DESCRIPTION	[ASSEMBLY INCLUDES]	REF. NO.	PART NO.	DESCRIPTION
* 40	A-1415-692-A	HB (VAR) BOARD, MOUNTED		\triangle 49	1-900-803-22	WIRE ASSY, G2 LEAD
\triangle 41	8-598-594-30	TUNER, FSS BTF-FA421		* 50	A-1302-979-A	A BOARD, COMPLETE The high-voltage leads associated with the FBT on the A board are not included and must be ordered separately. (See 47-49)
\triangle 42	1-766-374-11	PLUG, F-PIN		* 51	4-076-951-01	HINGE, PWB
\triangle 43	1-824-069-11	CORD, AC POWER (WITH CONNECTOR)				
* 44	4-102-308-01	LABEL, TERMINAL				
45	4-102-302-01	COVER, REAR				
\triangle 46	1-453-316-21	FBT ASSY NX-1748//X4A4	[47-49]			
\triangle 47	1-251-642-52	CAP ASSY, HIGH-VOLTAGE				
\triangle 48	1-900-800-65	CONNECTOR ASSY, FOCUS LEAD				





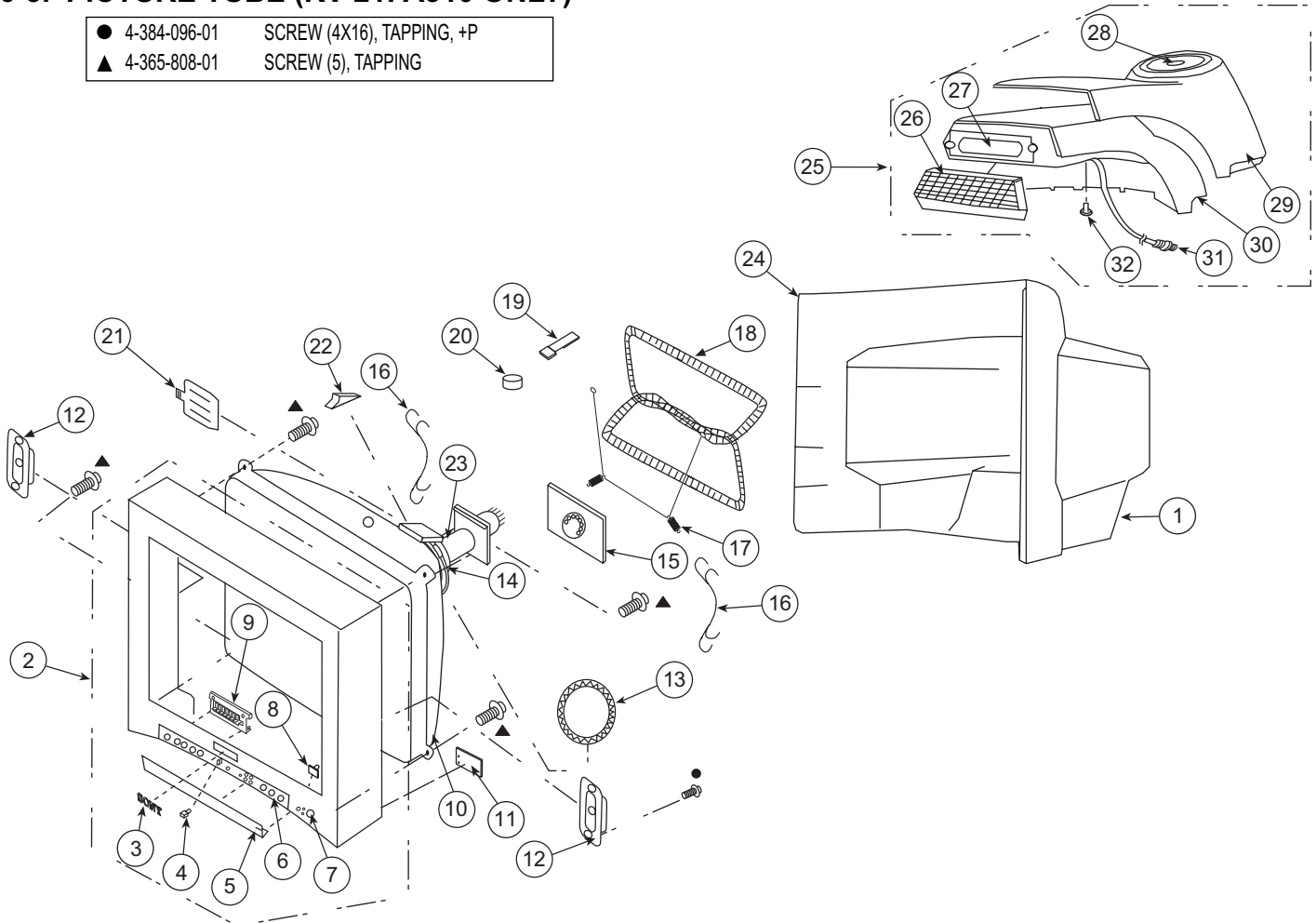

NOTE: The components identified by shading and  mark are critical for safety. Replace only with part number specified.

NOTE: Les composants identifiés par un trame et une marque  sont critiques pour la securite. Ne les remplacer que par une piece portant le numero specifie.

6-5. PICTURE TUBE (KV-21FA310 ONLY)

- 4-384-096-01 SCREW (4X16), TAPPING, +P
- ▲ 4-365-808-01 SCREW (5), TAPPING



REF. NO.	PART NO.	DESCRIPTION	[ASSEMBLY INCLUDES]	REF. NO.	PART NO.	DESCRIPTION	[ASSEMBLY INCLUDES]
* 1	4-094-381-11	LABEL, 21FA TERMINAL		* 16	4-080-810-21	BAND, DEGAUSS COIL	
2	X-4043-168-1	BEZNET ASSY	[3-9]	* 17	4-375-394-01	SPRING, TENSION	
3	4-046-161-21	EMBLEM, SONY NO.8		 18	1-456-153-11	COIL, DEGAUSSING	
4	4-042-192-01	CATCHER, PUSH		19	4-083-414-01	PIECE A(110), CONV CORRECT	
5	4-087-155-11	DOOR, CONTROL		20	1-452-032-00	MAGNET, DISC	
6	4-074-895-71	LABEL, FRONT TERMINAL (20)		21	4-057-714-01	PIECE ASSY, TLH CORRECTION	
7	4-087-150-41	BUTTON, POWER		 22	4-053-005-01	SPACER, DY	
8	4-087-156-01	GUIDE, LIGHT		 23	1-451-561-21	NECK ASSEMBLY	
9	4-087-151-01	BUTTON, MULTI		24	4-087-153-04	COVER, REAR	
 10	8-738-831-05	CRT 21RSN(SDP) (KV-21FA310 L NORTH ONLY)		* 25	A-1606-602-A	SPEAKER ASSY (21)	[26-32]
 10	8-738-838-05	CRT 21RSN(SDP)(SOUTH) (KV-21FA310 L SOUTH ONLY)		* 26	4-101-825-01	GRILLE, CENTER (W21)	
* 11	A-1415-629-A	HR (VAR) BOARD, MOUNTED		27	1-825-809-11	LOUDSPEAKER (19.2CMX4.2CM)	
12	1-825-808-11	LOUDSPEAKER (19.2CMX4.2CM)		28	1-825-807-11	LOUDSPEAKER (13CM)	
 13	1-456-285-11	COIL, NA ROTATION (RT-154)		* 29	4-101-822-01	COVER, TOP (W21)	
 14	8-451-505-71	DY Y21RSA-V		* 30	4-101-823-01	COVER, BOTTOM (W21)	
* 15	A-1410-919-A	CV (VAR) BOARD, MOUNTED		* 31	1-828-903-11	CONNECTION CABLE	
				* 32	4-068-528-41	FOOT	







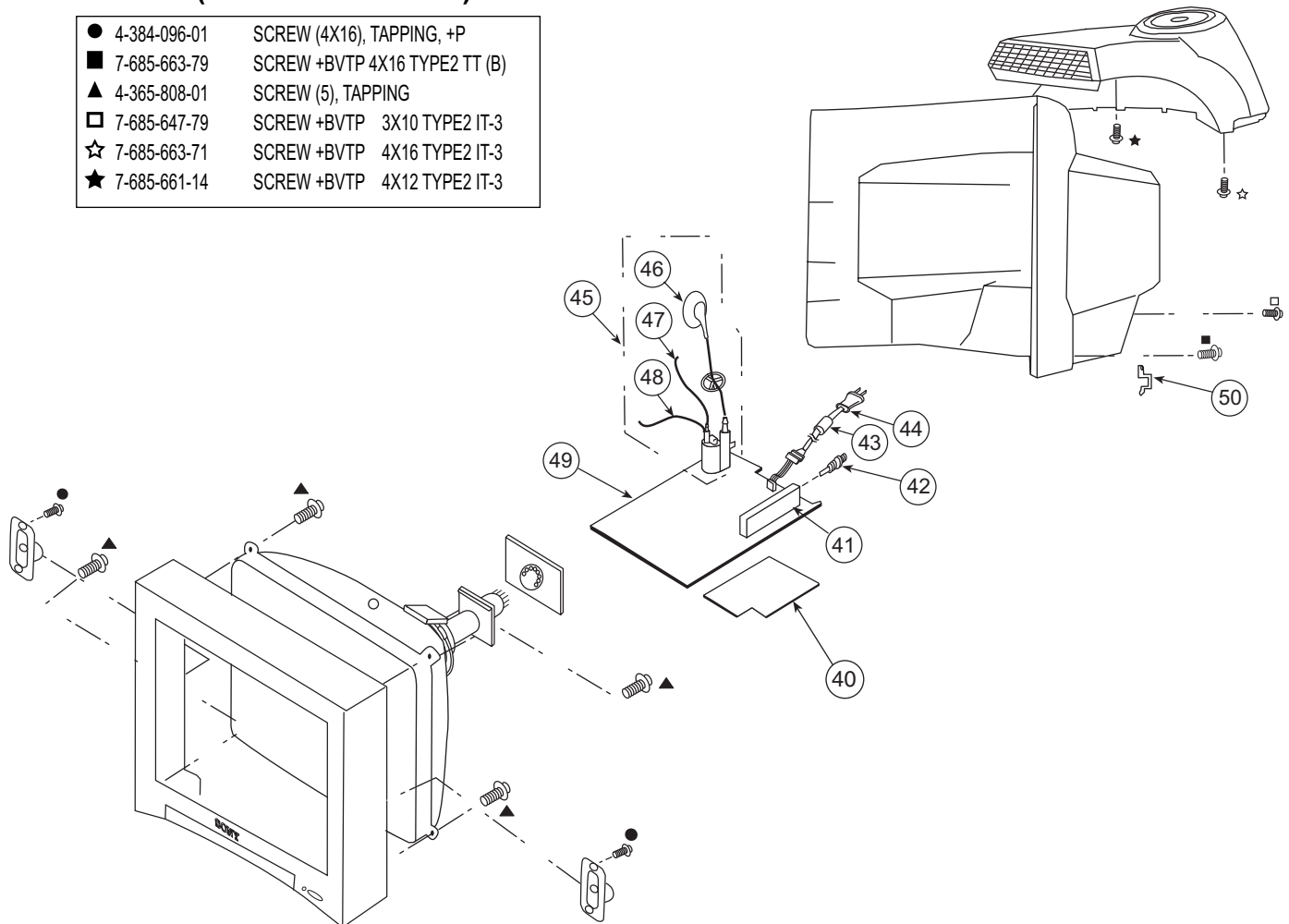

NOTE: The components identified by shading and  mark are critical for safety. Replace only with part number specified.

NOTE: Les composants identifiés par un triangle et une marque  sont critiques pour la sécurité. Ne les remplacer que par une pièce portant le numéro spécifié.

6-6. CHASSIS (KV-21FA310 ONLY)

●	4-384-096-01	SCREW (4X16), TAPPING, +P
■	7-685-663-79	SCREW +BVTP 4X16 TYPE2 TT (B)
▲	4-365-808-01	SCREW (5), TAPPING
□	7-685-647-79	SCREW +BVTP 3X10 TYPE2 IT-3
☆	7-685-663-71	SCREW +BVTP 4X16 TYPE2 IT-3
★	7-685-661-14	SCREW +BVTP 4X12 TYPE2 IT-3



REF. NO.	PART NO.	DESCRIPTION	[ASSEMBLY INCLUDES]	REF. NO.	PART NO.	DESCRIPTION
* 40	A-1410-921-A	K BOARD, MOUNTED		* 49	A-1302-879-A	A BOARD, COMPLETE (KV-21FA310 L NORTH ONLY)
 41	8-598-593-50	TUNER, FSS BTF-WA421				The high-voltage leads associated with the FBT on the A board are not included and must be ordered separately. (See 46-48)
 42	1-766-374-11	PLUG, F-PIN		* 49	A-1302-953-A	A BOARD, COMPLETE (KV-21FA310 L SOUTH ONLY)
43	1-500-586-11	FILTER, CLAMP (FERRITE CORE) (KV-21FA310 L SOUTH ONLY)				The high-voltage leads associated with the FBT on the A board are not included and must be ordered separately. (See 46-48)
 44	1-824-069-11	CORD, AC POWER (WITH CONNECTOR) (KV-21FA310 L NORTH ONLY)		* 50	4-081-980-11	HOLDER, AC CABLE
 44	1-757-840-12	CORD, POWER (WITH CONNECTOR) (KV-21FA310 L SOUTH ONLY)				
 45	1-453-316-21	FBT ASSY NX-1748//X4A4	[46-48]			
 46	1-251-642-52	CAP ASSY, HIGH-VOLTAGE				
 47	1-900-800-65	CONNECTOR ASSY, FOCUS LEAD				
 48	1-900-803-22	WIRE ASSY, G2 LEAD				

NOTE: The components identified by shading and \triangle mark are critical for safety. Replace only with part number specified.

NOTE: Les composants identifiés par un triangle et une marque \triangle sont critiques pour la sécurité. Ne les remplacer que par une pièce portant le numéro spécifié.

6-7. PICTURE TUBE (KV-24FS120/25FS120 ONLY)

- 4-384-096-01 SCREW (4X16), TAPPING, +P
- ▲ 4-046-765-12 SCREW, TAPPING 7+CROWN WASHER

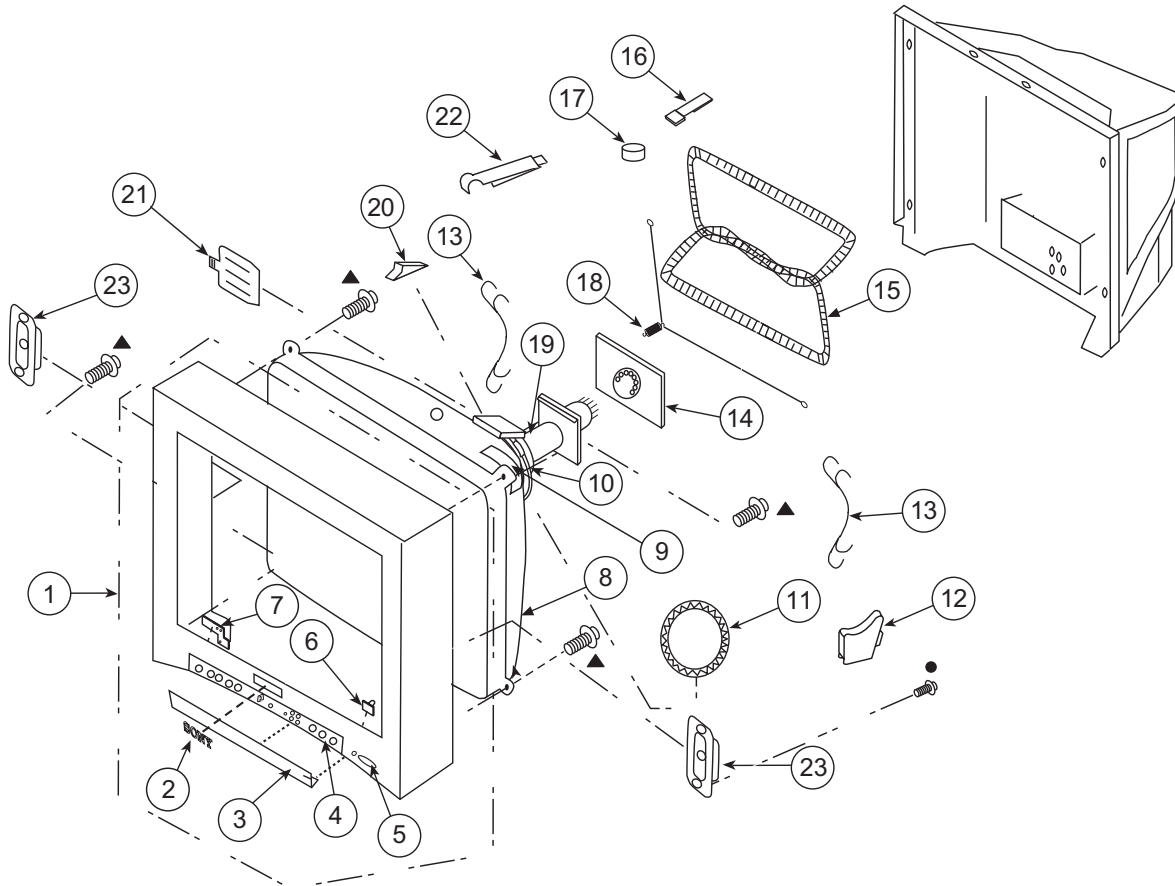

REF. NO.	PART NO.	DESCRIPTION	[ASSEMBLY INCLUDES]	REF. NO.	PART NO.	DESCRIPTION
1	X-4042-991-1	BEZNET ASSY	[2-7]	\triangle 15	1-419-509-21	COIL, DEGAUSSING (ALL EXCEPT KV-25FS120 L. SOUTH)
2	4-046-160-31	EMBLEM, SONY NO.9		\triangle 15	1-456-576-11	DEGAUSSING COIL (KV-25FS120 L. SOUTH ONLY)
3	4-102-301-11	DOOR		16	4-083-414-01	PIECE A(110), CONV CORRECT
4	4-102-307-01	LABEL, DOOR		17	1-452-032-00	MAGNET,DISC
5	4-102-305-11	BUTTON, POWER		18	4-036-329-01	SPRING (B), TENSION
6	4-102-306-01	GUIDE, LED/IR		\triangle 19	1-451-561-21	NECK ASSEMBLY
* 7	4-083-303-01	SPRING, METAL		\triangle 20	4-053-005-01	SPACER, DY
\triangle 8	8-733-250-05	CRT 25RSN		21	4-057-714-01	PIECE ASSY, TLH CORRECTION
9	4-089-346-01	CUSHION, DGC		22	4-102-312-01	CLIP, DGC
\triangle 10	1-451-475-11	DEFLECTION YOKE (Y25RSA)		23	1-825-831-11	LOUDSPEAKER (15X6.5CM)
\triangle 11	1-452-896-11	COIL, NA ROTATION (RT-200)				
12	4-102-536-01	SUPPORT, CRT(24)				
* 13	4-080-810-21	BAND, DEGAUSS COIL				
* 14	A-1415-605-A	CV (VAR) BOARD, MOUNTED				







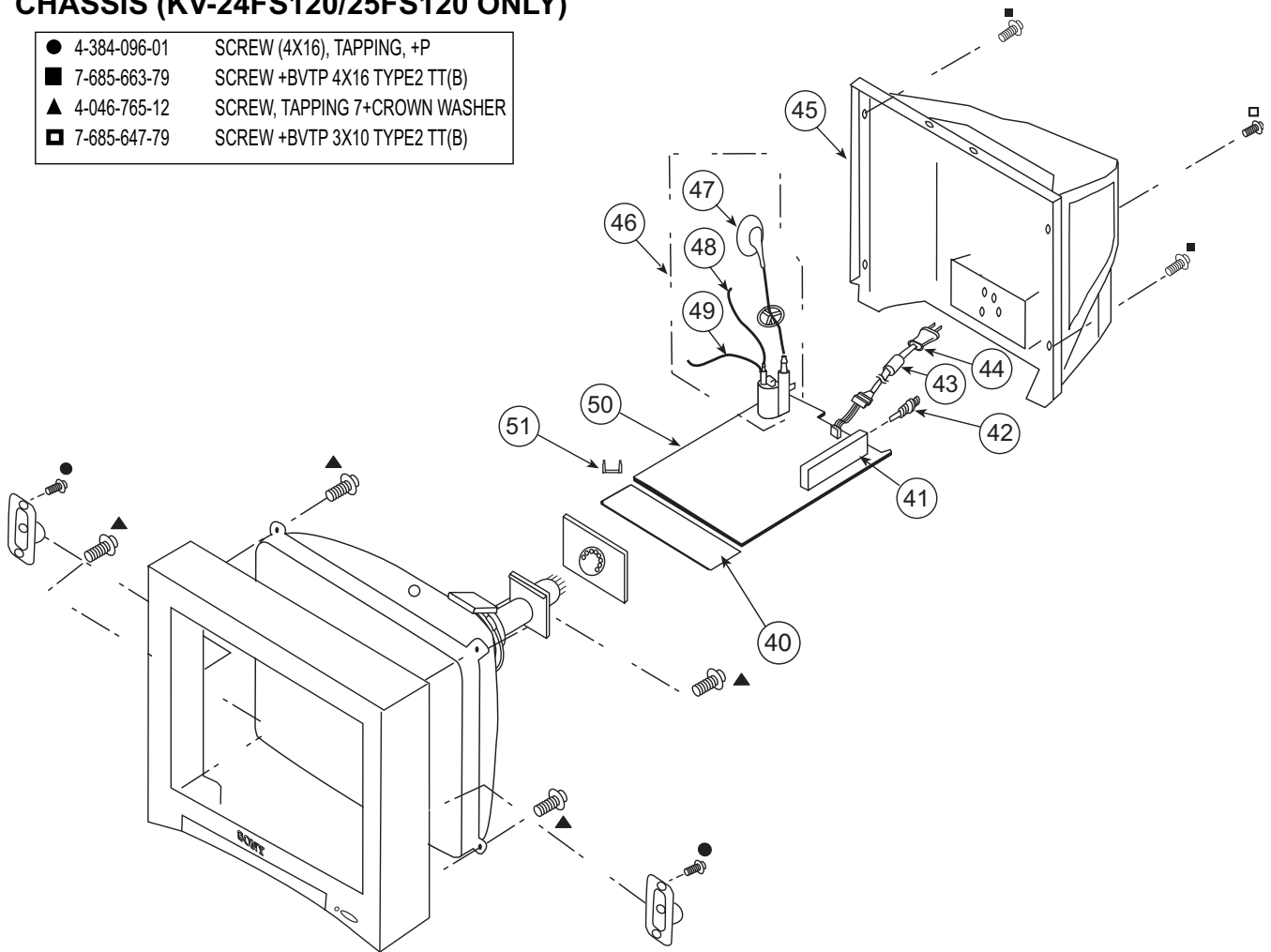

NOTE: The components identified by shading and  mark are critical for safety. Replace only with part number specified.

NOTE: Les composants identifiés par un triangle et une marque  sont critiques pour la sécurité. Ne les remplacer que par une pièce portant le numéro spécifié.

6-8. CHASSIS (KV-24FS120/25FS120 ONLY)

- 4-384-096-01 SCREW (4X16), TAPPING, +P
- 7-685-663-79 SCREW +BVTP 4X16 TYPE2 TT(B)
- ▲ 4-046-765-12 SCREW, TAPPING 7+CROWN WASHER
- ▣ 7-685-647-79 SCREW +BVTP 3X10 TYPE2 TT(B)



REF. NO.	PART NO.	DESCRIPTION	[ASSEMBLY INCLUDES]	REF. NO.	PART NO.	DESCRIPTION
* 40	A-1415-580-A	HB (VAR) BOARD, MOUNTED		* 50	A-1302-944-A	A BOARD, COMPLETE (ALL EXCEPT KV-25FS120 L. SOUTH)
 41	8-598-593-50	TUNER, FSS BTF-WA421				The high-voltage leads associated with the FBT on the A board are not included and must be ordered separately. (See 47-49)
 42	1-766-374-11	PLUG, F-PIN		* 50	A-1303-007-A	A BOARD, COMPLETE (KV-25FS120 L. SOUTH ONLY)
43	1-500-586-11	FILTER, CLAMP (FERRITE CORE) (KV-25FS120 L. SOUTH ONLY)				The high-voltage leads associated with the FBT on the A board are not included and must be ordered separately. (See 47-49)
 44	1-824-069-11	CORD, AC POWER(WITH CONNECTOR) (ALL EXCEPT KV-25FS120 L. SOUTH)		* 51	4-076-951-01	HINGE, PWB
 44	1-757-840-12	CORD, POWER (WITH CONNECTOR) (KV-25FS120 L. SOUTH ONLY)				
45	4-102-310-01	COVER, REAR				
 46	1-453-336-11	FBT ASSY NX-4011//X4A4	[47-49]			
 47	1-251-642-52	CAP ASSY, HIGH-VOLTAGE				
 48	1-900-800-65	CONNECTOR ASSY, FOCUS LEAD				
 49	1-900-803-22	WIRE ASSY, G2 LEAD				

SECTION 7: ELECTRICAL PARTS LIST

NOTE: The components identified by shading and \triangle mark are critical for safety. Replace only with part number specified.

NOTE: Les composants identifiés par un trame et une marque \triangle sont critiques pour la sécurité. Ne les remplacer que par une pièce portant le numéro spécifié.

The components in this manual identified by the following symbol: \boxtimes indicate parts that have been carefully factory-selected to satisfy regulations regarding X-ray radiation for each set.

Should replacement be required for one of these components, replace only with the value originally used.

* Items marked with an asterisk are not stocked since they are seldom required for routine service. Expect some delay when ordering these components.

RESISTORS

- All resistors are in ohms
- F : nonflammable
- All variable and adjustable resistors have characteristic curve B, unless otherwise noted.



When ordering parts by reference number, please include the board name.

REF. NO.	PART NO.	DESCRIPTION	VALUES	REF. NO.	PART NO.	DESCRIPTION	VALUES
A				C014	1-126-960-11	ELECT	1 μ F 20% 50V
*	A-1302-879-A	A BOARD, COMPLETE (KV-21FA310 LATIN NORTH ONLY)		C015	1-107-826-11	CERAMIC CHIP	0.1 μ F 10% 16V
*	A-1302-931-A	A BOARD, COMPLETE (KV-20FS120/21FS120 LATIN NORTH ONLY)		C019	1-126-956-91	ELECT	0.1 μ F 20% 50V
*	A-1302-944-A	A BOARD, COMPLETE (KV-24FS120/25FS120 LATIN NORTH ONLY)		C021	1-107-826-11	CERAMIC CHIP	0.1 μ F 10% 16V
*	A-1302-953-A	A BOARD, COMPLETE (KV-21FA310 LATIN SOUTH ONLY)		C022	1-126-964-11	ELECT	10 μ F 20% 50V
*	A-1302-979-A	A BOARD, COMPLETE (KV-21FM120 ONLY)		C023	1-126-935-11	ELECT	470 μ F 20% 16V
*	A-1302-980-A	A BOARD, COMPLETE (KV-21FS120 LATIN SOUTH ONLY)		C033	1-162-970-11	CERAMIC CHIP	0.01 μ F 10% 25V
*	A-1303-007-A	A BOARD, COMPLETE (KV-25FS120 LATIN SOUTH ONLY)		C041	1-126-964-11	ELECT	10 μ F 20% 50V
\triangle	1-533-223-11	FUSE HOLDER	0A 0V	C047	1-164-315-11	CERAMIC CHIP	470pF 5% 50V
*	4-374-846-11	COVER, CAPACITOR, CAP TYPE		C048	1-104-665-11	ELECT	100 μ F 20% 25V
	4-382-854-11	SCREW (M3X10), P, SW (+)		C049	1-126-960-11	ELECT	1 μ F 20% 50V
				C051	1-126-964-11	ELECT	10 μ F 20% 50V
				C052	1-164-230-11	CERAMIC CHIP	220pF 5% 50V
				C053	1-165-176-11	CERAMIC CHIP	0.047 μ F 10% 16V
				C054	1-126-960-11	ELECT	1 μ F 20% 50V
				C056	1-162-966-11	CERAMIC CHIP	0.0022 μ F 10% 50V
				C057	1-107-826-11	CERAMIC CHIP	0.1 μ F 10% 16V
				C064	1-165-176-11	CERAMIC CHIP	0.047 μ F 10% 16V
				C074	1-126-964-11	ELECT	10 μ F 20% 50V
				C075	1-126-935-11	ELECT	470 μ F 20% 16V
\triangle	1-251-642-52	CAP ASSY, HIGH-VOLTAGE		C076	1-104-665-11	ELECT	100 μ F 20% 25V
\triangle	1-900-803-22	WIRE ASSY, G2 LEAD		C077	1-126-947-11	ELECT	47 μ F 20% 35V
\triangle	1-900-800-65	CONNECTOR ASSY, FOCUS LEAD		C079	1-162-968-11	CERAMIC CHIP	0.0047 μ F 10% 50V
				C080	1-128-934-91	CERAMIC CHIP	0.33 μ F 20% 10V
				C081	1-128-934-91	CERAMIC CHIP	0.33 μ F 20% 10V
				C090	1-162-970-11	CERAMIC CHIP	0.01 μ F 10% 25V
				C091	1-126-947-11	ELECT	47 μ F 20% 35V
				C092	1-126-947-11	ELECT	47 μ F 20% 35V
				C094	1-162-970-11	CERAMIC CHIP	0.01 μ F 10% 25V
				C095	1-126-947-11	ELECT	47 μ F 20% 35V
				C096	1-162-970-11	CERAMIC CHIP	0.01 μ F 10% 25V
				C097	1-126-947-11	ELECT	47 μ F 20% 35V
				C098	1-162-970-11	CERAMIC CHIP	0.01 μ F 10% 25V
				C099	1-126-947-11	ELECT	47 μ F 20% 35V
				C100	1-126-956-91	ELECT	0.1 μ F 20% 50V

CAPACITOR

C003	1-162-919-11	CERAMIC CHIP	22pF	5%	50V
C004	1-162-923-11	CERAMIC CHIP	47pF	5%	50V
C005	1-162-966-11	CERAMIC CHIP	0.0022 μ F	10%	50V
C006	1-126-942-61	ELECT	1000 μ F	20%	25V
C007	1-164-315-11	CERAMIC CHIP	470pF	5%	50V
C008	1-126-956-91	ELECT	0.1 μ F	20%	50V
C009	1-164-230-11	CERAMIC CHIP	220pF	5%	50V
C010	1-126-960-11	ELECT	1 μ F	20%	50V
C011	1-162-964-11	CERAMIC CHIP	0.001 μ F	10%	50V
C012	1-162-968-11	CERAMIC CHIP	0.0047 μ F	10%	50V



REF. NO.	PART NO.	DESCRIPTION	VALUES			REF. NO.	PART NO.	DESCRIPTION	VALUES		
C115	1-164-739-11	CERAMIC CHIP	560pF	5%	50V	C404	1-162-967-11	CERAMIC CHIP	0.0033μF	10%	50V
C116	1-107-826-11	CERAMIC CHIP	0.1μF	10%	16V			(KV-21FA310LN/21FA310LS ONLY)			
C200	1-125-891-11	CERAMIC CHIP	0.47μF	10%	10V	C405	1-164-677-11	CERAMIC CHIP	0.033μF	10%	16V
C202	1-125-891-11	CERAMIC CHIP	0.47μF	10%	10V			(KV-21FA310LN/21FA310LS ONLY)			
C203	1-125-891-11	CERAMIC CHIP	0.47μF	10%	10V	C406	1-164-677-11	CERAMIC CHIP	0.033μF	10%	16V
								(KV-21FA310LN/21FA310LS ONLY)			
C204	1-125-891-11	CERAMIC CHIP	0.47μF	10%	10V	C407	1-162-965-11	CERAMIC CHIP	0.0015μF	10%	50V
		(KV-21FA310LN/21FA310LS ONLY)						(KV-21FA310LN/21FA310LS ONLY)			
C204	1-216-864-11	CHIP, CONDUCTOR	0			C407	1-162-966-11	CERAMIC CHIP	0.0022μF	10%	50V
		(ALL EXCEPT KV-21FA310LN/21FA310LS)						(ALL EXCEPT KV-21FA310LN/21FA310LS)			
C205	1-125-891-11	CERAMIC CHIP	0.47μF	10%	10V	C408	1-162-965-11	CERAMIC CHIP	0.0015μF	10%	50V
		(KV-21FA310LN/21FA310LS ONLY)						(KV-21FA310LN/21FA310LS ONLY)			
C205	1-216-864-11	CHIP, CONDUCTOR	0			C408	1-162-966-11	CERAMIC CHIP	0.0022μF	10%	50V
		(ALL EXCEPT KV-21FA310LN/21FA310LS)						(ALL EXCEPT KV-21FA310LN/21FA310LS)			
C212	1-126-963-11	ELECT	4.7μF	20%	50V	C409	1-127-715-91	CERAMIC CHIP	0.22μF	10%	16V
		(KV-21FA310LN/21FA310LS ONLY)						(KV-21FA310LN/21FA310LS ONLY)			
C213	1-126-963-11	ELECT	4.7μF	20%	50V	C409	1-107-826-11	CERAMIC CHIP	0.1μF	10%	16V
		(KV-21FA310LN/21FA310LS ONLY)						(ALL EXCEPT KV-21FA310LN/21FA310LS)			
C220	1-125-891-11	CERAMIC CHIP	0.47μF	10%	10V	C410	1-127-715-91	CERAMIC CHIP	0.22μF	10%	16V
C301	1-126-956-91	ELECT	0.1μF	20%	50V			(KV-21FA310LN/21FA310LS ONLY)			
C302	1-126-956-91	ELECT	0.1μF	20%	50V	C410	1-107-826-11	CERAMIC CHIP	0.1μF	10%	16V
C303	1-126-956-91	ELECT	0.1μF	20%	50V			(ALL EXCEPT KV-21FA310LN/21FA310LS)			
C304	1-126-956-91	ELECT	0.1μF	20%	50V	C411	1-128-934-91	CERAMIC CHIP	0.33μF	20%	10V
								(KV-21FA310LN/21FA310LS ONLY)			
C305	1-107-826-11	CERAMIC CHIP	0.1μF	10%	16V	C412	1-126-960-11	ELECT	1μF	20%	50V
C306	1-107-826-11	CERAMIC CHIP	0.1μF	10%	16V			(KV-21FA310LN/21FA310LS ONLY)			
C307	1-107-826-11	CERAMIC CHIP	0.1μF	10%	16V	C412	1-124-252-00	ELECT	0.33μF	20%	50V
C309	1-107-826-11	CERAMIC CHIP	0.1μF	10%	16V			(ALL EXCEPT KV-21FA310LN/21FA310LS)			
C313	1-126-956-91	ELECT	0.1μF	20%	50V	C413	1-126-963-11	ELECT	4.7μF	20%	50V
C318	1-126-964-11	ELECT	10μF	20%	50V	C414	1-126-961-11	ELECT	2.2μF	20%	50V
C319	1-126-964-11	ELECT	10μF	20%	50V	C415	1-126-963-11	ELECT	4.7μF	20%	50V
C325	1-162-967-11	CERAMIC CHIP	0.0033μF	10%	50V	C416	1-126-960-11	ELECT	1μF	20%	50V
C326	1-164-505-11	CERAMIC CHIP	2.2μF	16V		C417	1-126-960-11	ELECT	1μF	20%	50V
C328	1-162-970-11	CERAMIC CHIP	0.01μF	10%	25V			(ALL EXCEPT KV-21FA310LN/21FA310LS)			
						C418	1-126-963-11	ELECT	4.7μF	20%	50V
C330	1-162-970-11	CERAMIC CHIP	0.01μF	10%	25V			(KV-21FA310LN/21FA310LS ONLY)			
C337	1-162-919-11	CERAMIC CHIP	22pF	5%	50V	C419	1-125-891-11	CERAMIC CHIP	0.47μF	10%	10V
C351	1-164-315-11	CERAMIC CHIP	470pF	5%	50V	C420	1-126-960-11	ELECT	1μF	20%	50V
C370	1-162-968-11	CERAMIC CHIP	0.0047μF	10%	50V	C421	1-126-965-91	ELECT	22μF	20%	50V
C390	1-162-970-11	CERAMIC CHIP	0.01μF	10%	25V						
C400	1-128-934-91	CERAMIC CHIP	0.33μF	20%	10V	C422	1-126-960-11	ELECT	1μF	20%	50V
		(KV-21FA310LN/21FA310LS ONLY)				C423	1-126-963-11	ELECT	4.7μF	20%	50V
C401	1-164-227-11	CERAMIC CHIP	0.022μF	10%	25V	C424	1-125-891-11	CERAMIC CHIP	0.47μF	10%	10V
C402	1-164-174-11	CERAMIC CHIP	0.0082μF	10%	25V						
		(KV-21FA310LN/21FA310LS ONLY)				C430	1-126-963-11	ELECT	4.7μF	20%	50V
								(ALL EXCEPT KV-21FM120)			
C403	1-162-967-11	CERAMIC CHIP	0.0033μF	10%	50V						
		(KV-21FA310LN/21FA310LS ONLY)									

NOTE: The components identified by shading and \triangle mark are critical for safety. Replace only with part number specified.

NOTE: Les composants identifiés par un trame et une marque \triangle sont critiques pour la sécurité. Ne les remplacer que par une pièce portant le numéro spécifique.



REF. NO.	PART NO.	DESCRIPTION	VALUES			REF. NO.	PART NO.	DESCRIPTION	VALUES		
C431	1-126-963-11	ELECT (ALL EXCEPT KV-21FM120)	4.7 μ F	20%	50V	C509	1-126-964-11	ELECT	10 μ F	20%	50V
C436	1-107-826-11	CERAMIC CHIP	0.1 μ F	10%	16V	C510	1-117-214-11	CERAMIC	0.001 μ F	10%	2KV
C440	1-126-965-91	ELECT (KV-21FA310LN/21FA310LS ONLY)	22 μ F	20%	50V	C511	1-115-521-11	FILM (ALL EXCEPT KV-24FS120/25FS120LN/25FS120LS)	0.82 μ F	5%	250V
C441	1-126-965-91	ELECT (KV-21FA310LN/21FA310LS ONLY)	22 μ F	20%	50V	C511	1-117-813-11	FILM (KV-24FS120/25FS120LN/25FS120LS ONLY)	0.75 μ F	5%	250V
C450	1-126-943-11	ELECT	2200 μ F	20%	25V	C512	1-104-987-11	MYLAR	0.001 μ F	5%	200V
C451	1-126-959-11	ELECT	0.47 μ F	20%	50V	C513	1-106-383-00	MYLAR	0.047 μ F	10%	200V
C452	1-126-960-11	ELECT	1 μ F	20%	50V	C514	1-115-519-11	FILM (ALL EXCEPT KV-24FS120/25FS120LN/25FS120LS)	0.82 μ F	5%	250V
C457	1-165-176-11	CERAMIC CHIP (KV-21FA310LN/21FA310LS ONLY)	0.047 μ F	10%	16V	C514	1-115-521-11	FILM (KV-24FS120/25FS120LN/25FS120LS ONLY)	0.56 μ F	5%	250V
C457	1-127-715-91	CERAMIC CHIP (ALL EXCEPT 21FA310LN/21FA310LS)	0.22 μ F	10%	16V	C515	1-107-651-11	ELECT	4.7 μ F	20%	250V
C458	1-165-176-11	CERAMIC CHIP (KV-21FA310LN/21FA310LS ONLY)	0.047 μ F	10%	16V	C516	1-117-661-11	ELECT (KV-24FS120/25FS120LN/25FS120LS ONLY)	0.15 μ F	5%	250V
C458	1-127-715-91	CERAMIC CHIP (ALL EXCEPT 21FA310LN/21FA310LS)	0.22 μ F	10%	16V	C519	1-216-864-11	SHORT CHIP (ALL EXCEPT KV-24FS120/25FS120LN/25FS120LS)			
C460	1-126-943-11	ELECT	2200 μ F	20%	25V	C519	1-216-828-11	METAL CHIP (KV-24FS120/25FS120LN/25FS120LS ONLY)	3.9K	5%	1/10W
C461	1-126-943-11	ELECT	2200 μ F	20%	25V	C520	1-126-965-91	ELECT	22 μ F	20%	50V
C462	1-126-943-11	ELECT	2200 μ F	20%	25V	C521	1-126-960-11	ELECT	1 μ F	20%	50V
C463	1-126-943-11	ELECT	2200 μ F	20%	25V	C522	1-102-244-00	CERAMIC	220pF	10%	500V
C470	1-126-935-11	ELECT (KV-21FA310LN/21FA310LS ONLY)	470 μ F	20%	16V	C523	1-165-529-11	MYLAR	0.22 μ F	10	275V
C501	1-126-959-11	ELECT	0.47 μ F	20%	50V	C525	1-164-646-11	CERAMIC	2200pF	10%	500V
C502	1-102-112-00	CERAMIC	330pF	10%	50V	C526	1-102-244-00	CERAMIC	220pF	10%	500V
C503	1-106-383-00	MYLAR	0.047 μ F	10%	200V	C527	1-107-645-11	ELECT	22 μ F	20%	200V
C504	1-102-228-00	CERAMIC	470pF	10%	500V	C529	1-164-690-91	CERAMIC CHIP	0.0022 μ F	5%	50V
C505	1-102-228-00	CERAMIC	470pF	10%	500V	C534	1-164-315-11	CERAMIC CHIP (ALL EXCEPT KV-24FS120/25FS120LN/25FS120LS)	470pF	5%	50V
\triangle C506	1-117-214-11	CERAMIC (ALL EXCEPT KV-24FS120/25FS120LN/25FS120LS)	0.001 μ F	10%	2KV	C534	1-162-966-11	CERAMIC CHIP (KV-24FS120/25FS120LN/25FS120LS ONLY)	0.0022 μ F	10%	50V
\triangle C506	1-162-116-00	CERAMIC (KV-24FS120/25FS120LN/25FS120LS ONLY)	680pF	10%	2KV	C535	1-137-372-11	MYLAR (ALL EXCEPT KV-24FS120/25FS120LN/25FS120LS)	0.022 μ F	5%	50V
\triangle C507	1-117-642-11	FILM (ALL EXCEPT KV-24FS120/25FS120LN/25FS120LS)	8200pF	3%	1.2KV	C536	1-164-315-11	CERAMIC CHIP (ALL EXCEPT KV-24FS120/25FS120LN/25FS120LS)	470pF	5%	50V
\triangle C507	1-127-717-21	FILM (KV-24FS120/25FS120LN/25FS120LS ONLY)	19000pF	3%	1.2KV	C536	1-162-966-11	CERAMIC CHIP (KV-24FS120/25FS120LN/25FS120LS ONLY)	0.0022 μ F	10%	50V
\triangle C508	1-129-722-00	FILM (ALL EXCEPT KV-24FS120/25FS120LN/25FS120LS)	0.047 μ F	5%	630V	C537	1-162-964-11	CERAMIC CHIP	0.001 μ F	10%	50V
\triangle C508	1-130-895-00	FILM (KV-24FS120/25FS120LN/25FS120LS ONLY)	0.056 μ F	5%	400V	C539	1-162-970-11	CERAMIC CHIP	0.01 μ F	10%	25V
						C542	1-162-966-11	CERAMIC CHIP	0.0022 μ F	10%	50V
						C544	1-126-967-11	ELECT	47 μ F	20%	50V
						C545	1-126-969-11	ELECT	220 μ F	20%	50V
						C546	1-137-194-81	FILM	0.47 μ F	5%	50V

NOTE: The components identified by shading and \triangle mark are critical for safety. Replace only with part number specified.

NOTE: Les composants identifiés par un trame et une marque \triangle sont critiques pour la sécurité. Ne les remplacer que par une pièce portant le numéro spécifique.



REF. NO.	PART NO.	DESCRIPTION	VALUES			REF. NO.	PART NO.	DESCRIPTION	VALUES		
C549	1-101-821-00	CERAMIC	0.0022 μ F	500V		C621	1-165-921-11	ELECT	390 μ F	20%	250V
C550	1-104-666-11	ELECT	220 μ F	20%	25V		(KV-21FM120 ONLY)				
C551	1-126-960-11	ELECT	1 μ F	20%	50V	C624	1-107-636-11	ELECT	10 μ F	20%	160V
C552	1-126-964-11	ELECT	10 μ F	20%	50V	C625	1-126-964-11	ELECT	10 μ F	20%	50V
C553	1-107-826-11	CERAMIC CHIP	0.1 μ F	10%	16V	C629	1-117-893-11	ELECT	470 μ F	20%	250V
							(ALL EXCEPT KV-21FM120)				
C554	1-162-970-11	CERAMIC CHIP	0.01 μ F	10%	25V	C629	1-165-921-11	ELECT	390 μ F	20%	250V
C555	1-101-821-00	CERAMIC	0.0022 μ F	500V			(KV-21FM120 ONLY)				
C558	1-162-318-11	CERAMIC	0.001 μ F	10%	500V	\triangle C631	1-113-896-11	CERAMIC	220pF	10%	250V
C559	1-216-864-11	SHORT CHIP				C632	1-126-967-11	ELECT	47 μ F	20%	50V
C560	1-216-833-11	METAL CHIP	10K	5%	1/10W	C633	1-136-479-11	FILM	0.001 μ F	5%	100V
C561	1-126-963-11	ELECT	4.7 μ F	20%	50V	C634	1-126-947-11	ELECT	47 μ F	20%	35V
C562	1-104-666-11	ELECT	220 μ F	20%	25V	C635	1-126-963-11	ELECT	4.7 μ F	20%	50V
C563	1-162-970-11	CERAMIC CHIP	0.01 μ F	10%	25V	C636	1-127-715-91	CERAMIC CHIP	0.22 μ F	10%	16V
C566	1-107-635-11	ELECT	4.7 μ F	20%	160V	C637	1-127-715-91	CERAMIC CHIP	0.22 μ F	10%	16V
C570	1-107-826-11	CERAMIC CHIP	0.1 μ F	10%	16V	C638	1-104-665-11	ELECT	100 μ F	20%	25V
C571	1-104-665-11	ELECT	100 μ F	20%	25V	C640	1-164-645-11	CERAMIC	1000pF	10%	500V
C581	1-136-161-00	FILM	0.047 μ F	5%	50V	C642	1-126-969-11	ELECT	220 μ F	20%	50V
C582	1-106-387-00	MYLAR	0.068 μ F	10%	200V	C643	1-130-777-00	MYLAR	0.1 μ F	5%	100V
C585	1-104-666-11	ELECT	220 μ F	20%	25V	C645	1-162-964-11	CERAMIC CHIP	0.001 μ F	10%	50V
\triangle C588	1-137-417-11	MYLAR	0.015 μ F	10%	100V	C647	1-126-947-11	ELECT	47 μ F	20%	35V
C589	1-128-560-11	ELECT	22 μ F	20%	100V	C648	1-104-330-91	CERAMIC	470pF	10%	1KV
C590	1-126-964-11	ELECT	10 μ F	20%	50V		(ALL EXCEPT KV-21FM120)				
C594	1-123-024-21	ELECT	33 μ F		160V	C648	1-125-969-91	CERAMIC	680pF	10%	1KV
C595	1-104-666-11	ELECT	220 μ F	20%	25V		(KV-21FM120 ONLY)				
C597	1-104-666-11	ELECT	220 μ F	20%	25V	C650	1-126-942-61	ELECT	1000 μ F	20%	25V
C600	1-126-964-11	ELECT	10 μ F	20%	50V	C651	1-126-942-61	ELECT	1000 μ F	20%	25V
C601	1-117-703-11	CERAMIC	0.0047 μ F	250V		C652	1-164-227-11	CERAMIC CHIP	0.022 μ F	10%	25V
						C655	1-104-330-91	CERAMIC	470pF	10%	1KV
\triangle C602	1-165-529-11	MYLAR	0.22 μ F	10	275V		(ALL EXCEPT KV-21FM120)				
\triangle C603	1-165-529-11	MYLAR	0.22 μ F	10	275V	C655	1-125-969-91	CERAMIC	680pF	10%	1KV
							(KV-21FM120 ONLY)				
\triangle C605	1-117-699-11	CERAMIC	0.001 μ F	99%	250V	C660	1-126-947-11	ELECT	47 μ F	20%	35V
C609	1-126-942-61	ELECT	1000 μ F	20%	25V	C661	1-104-665-11	ELECT	100 μ F	20%	25V
C610	1-164-645-11	CERAMIC	1000pF	10%	500V	C665	1-104-665-11	ELECT	100 μ F	20%	25V
C611	1-126-971-11	ELECT	470 μ F	20%	50V	C672	1-137-756-22	FILM	22000pF	3%	800V
C612	1-126-961-11	ELECT	2.2 μ F	20%	50V		(ALL EXCEPT KV-21FM120)				
C613	1-161-964-91	CERAMIC	0.0047 μ F	250V		C672	1-165-608-11	FILM	15000pF	3%	800V
C615	1-161-964-91	CERAMIC	0.0047 μ F	250V			(KV-21FM120 ONLY)				
C616	1-126-943-11	ELECT	2200 μ F	20%	25V	C673	1-126-963-11	ELECT	4.7 μ F	20%	50V
C617	1-107-935-11	ELECT	330 μ F	20%	100V	\triangle C680	1-117-699-11	CERAMIC	0.001 μ F	99%	250V
C618	1-107-935-11	ELECT	330 μ F	20%	100V	C690	1-162-970-11	CERAMIC CHIP	0.01 μ F	10%	25V
C620	1-162-970-11	CERAMIC CHIP	0.01 μ F	10%	25V						
C621	1-117-893-11	ELECT	470 μ F	20%	250V		(ALL EXCEPT KV-21FM120)				

NOTE: The components identified by shading and  mark are critical for safety. Replace only with part number specified.

NOTE: Les composants identifiés par un trame et une  sont critiques pour la sécurité. Ne les remplacer que par une pièce portant le numéro spécifique.





REF. NO.	PART NO.	DESCRIPTION	VALUES	REF. NO.	PART NO.	DESCRIPTION	VALUES
CONNECTOR							
* CN002	1-564-509-11	PLUG, CONNECTOR (KV-21FA310LN/21FS310LS ONLY)	6P	D209	8-719-404-50	DIODE (ALL EXCEPT KV-21FA310LN/21FS310LS)	MA111-TX
* CN002	1-564-510-11	PLUG, CONNECTOR (ALL EXCEPT KV-21FA310LN/21FS310LS)	7P	D230	8-719-108-12	DIODE	RD9.1EW
* CN003	1-560-124-00	PLUG, CONNECTOR (2.5MM)	4P	D231	8-719-108-12	DIODE (KV-21FA310LN/24FS120/25FS120LN/21FA310LS/25FS120LS ONLY)	RD9.1EW
* CN005	1-564-515-11	PLUG, CONNECTOR (ALL EXCEPT KV-21FA310LN/21FS310LS)	12P	D232	8-719-108-12	DIODE	RD9.1EW
* CN401	1-564-507-11	PLUG, CONNECTOR (KV-21FA310LN/21FS310LS ONLY)	4P	D234	8-719-108-12	DIODE (ALL EXCEPT KV-21FM120)	RD9.1EW
* CN501	1-508-786-00	PIN, CONNECTOR (5MM PITCH)	2P	D235	8-719-108-12	DIODE (ALL EXCEPT KV-21FM120)	RD9.1EW
* CN515	1-580-798-11	CONNECTOR PIN (DY) (ALL EXCEPT KV-21FA310LN/21FS310LS)	6P	D236	8-719-108-12	DIODE (ALL EXCEPT KV-21FM120)	RD9.1EW
* CN586	1-564-509-11	PLUG, CONNECTOR	6P	D237	8-719-108-12	DIODE (KV-21FA310LN/24FS120/25FS120LN/21FA310LS/25FS120LS ONLY)	RD9.1EW
 * CN600	1-580-843-11	PIN, CONNECTOR (POWER)		D321	8-719-110-17	DIODE	RD10ESB2
DIODE							
D002	8-719-109-89	DIODE	RD5.6ESB2	D351	8-719-109-66	DIODE	RD3.3ESB2
D003	8-719-110-17	DIODE	RD10ESB2	D390	8-719-404-50	DIODE	MA111-TX
D004	8-719-110-17	DIODE	RD10ESB2	D401	8-719-921-63	DIODE	MTZJ-7.5B
D005	8-719-110-17	DIODE	RD10ESB2	D405	8-719-991-33	DIODE	1SS133T-77
D006	8-719-921-44	DIODE	MTZJ-5.1C	D412	1-216-864-11	SHORT CHIP	
D007	8-719-982-22	DIODE	MTZJ-30D	D414	8-719-921-63	DIODE (KV-21FA310LN/21FA310LS ONLY)	MTZJ-7.5B
D046	8-719-109-89	DIODE	RD5.6ESB2	D420	8-719-072-68	DIODE	PDZ13B-115
D047	8-719-109-89	DIODE	RD5.6ESB2	D430	8-719-929-15	DIODE (ALL EXCEPT KV-21FM120)	HZS9.1NB2
D050	8-719-510-02	DIODE	D1NS4	D431	8-719-929-15	DIODE (ALL EXCEPT KV-21FM120)	HZS9.1NB2
D051	6-500-175-01	DIODE	1E3-TB	D432	8-719-108-12	DIODE (ALL EXCEPT KV-21FA310LN/21FA310LS)	RD9.1EW
D052	8-719-109-89	DIODE	RD5.6ESB2	D500	8-719-404-50	DIODE	MA111-TX
D200	8-719-929-15	DIODE	HZS9.1NB2	D501	8-719-404-50	DIODE	MA111-TX
D201	8-719-929-15	DIODE	HZS9.1NB2	D505	8-719-081-00	DIODE	BY228/A52A/
D202	8-719-929-15	DIODE	HZS9.1NB2	D506	8-719-979-85	DIODE (ALL EXCEPT KV-24FS120/25FS120LN/25FS120LS)	EGP20G
D203	8-719-929-15	DIODE	HZS9.1NB2	D506	6-500-485-01	DIODE (KV-24FS120/25FS120LN/25FS120LS ONLY)	FR305G-E
D206	8-719-070-62	DIODE (KV-21FA310LN/21FS310LS ONLY)	PDZ9.1B-115	D507	8-719-991-33	DIODE	1SS133T-77
D207	1-216-864-11	SHORT CHIP (KV-21FA310LN/21FS310LS ONLY)		D508	8-719-404-50	DIODE	MA111-TX
D207	8-719-404-50	DIODE (ALL EXCEPT KV-21FA310LN/21FS310LS)	MA111-TX	D513	8-719-404-50	DIODE	MA111-TX
D208	8-719-929-15	DIODE (KV-21FA310LN/21FS310LS ONLY)	HZS9.1NB2	D514	8-719-908-03	DIODE	GP08D
D209	1-216-864-11	SHORT CHIP (KV-21FA310LN/21FS310LS ONLY)		D515	8-719-908-03	DIODE	GP08D
				D525	8-719-991-33	DIODE	1SS133T-77
				D526	8-719-074-25	DIODE	PG104R
				D528	8-719-991-33	DIODE	1SS133T-77

NOTE: The components identified by shading and  mark are critical for safety. Replace only with part number specified.

NOTE: Les composants identifiés par un trame et une  sont critiques pour la sécurité. Ne les remplacer que par une pièce portant le numéro spécifique.



REF. NO.	PART NO.	DESCRIPTION	VALUES	REF. NO.	PART NO.	DESCRIPTION	VALUES	
L516	1-406-978-11	INDUCTOR	150µH	Q412	8-729-422-27	TRANSISTOR	2SD601A-Q	
	(KV-24FS120/25FS120LN/25FS120LS ONLY)				(KV-21FA310LN/21FA310LS ONLY)			
L525	1-409-955-31	INDUCTOR	8MH	Q420	8-729-422-27	TRANSISTOR	2SD601A-Q	
L527	1-410-397-21	FERRITE	1.1µH	Q421	8-729-422-27	TRANSISTOR	2SD601A-Q	
L588	1-412-528-11	INDUCTOR	18µH	Q501	8-729-423-33	TRANSISTOR	2SC3311A-QRSTA	
L606	1-412-525-31	INDUCTOR	10µH	Q502	8-729-140-50	TRANSISTOR	2SC3209LK	
L607	1-412-525-31	INDUCTOR	10µH	Q503	8-729-424-02	TRANSISTOR	2SB709A-QRS-TX	
L608	1-412-533-21	INDUCTOR	47µH	Q504	8-729-422-27	TRANSISTOR	2SD601A-Q	
L609	1-412-525-31	INDUCTOR	10µH	Q505	6-550-041-01	TRANSISTOR	2SD2634-Y	
					(KV-24FS120/25FS120LN/25FS120LS ONLY)			
PHOTO COUPLER					Q506	6-550-042-01	TRANSISTOR	2SD2627LS-YB11
	PH602	8-749-010-64	PHOTO COUPLER	PC123F2		(ALL EXCEPT KV-24FS120/25FS120LN/25FS120LS)		
IC LINK				Q519	8-729-422-27	TRANSISTOR	2SD601A-Q	
PS401	1-576-337-21	IC LINK	2.7A 50V	Q521	8-729-423-33	TRANSISTOR	2SC3311A-QRSTA	
TRANSISTOR				Q522	8-729-053-87	TRANSISTOR	KTC4370A	
Q002	8-729-422-27	TRANSISTOR	2SD601A-Q	Q531	8-729-422-27	TRANSISTOR	2SD601A-Q	
Q004	8-729-422-27	TRANSISTOR	2SD601A-Q	Q533	8-729-424-02	TRANSISTOR	2SB709A-QRS-TX	
Q005	8-729-424-02	TRANSISTOR	2SB709A-QRS-TX	Q572	8-729-422-27	TRANSISTOR	2SD601A-Q	
Q006	8-729-422-27	TRANSISTOR	2SD601A-Q	Q573	8-729-424-02	TRANSISTOR	2SB709A-QRS-TX	
Q008	8-729-422-27	TRANSISTOR	2SD601A-Q	Q578	8-729-422-27	TRANSISTOR	2SD601A-Q	
Q009	8-729-422-27	TRANSISTOR	2SD601A-Q	Q590	6-550-362-01	TRANSISTOR	KTA1279	
Q300	8-729-422-27	TRANSISTOR	2SD601A-Q	Q600	8-729-053-36	TRANSISTOR	2SK2640-01MR-F122	
Q301	8-729-424-02	TRANSISTOR	2SB709A-QRS-TX		(ALL EXCEPT KV-21FM120)			
Q303	8-729-424-02	TRANSISTOR	2SB709A-QRS-TX	Q600	8-729-052-29	TRANSISTOR	2SK2876-01MR-F122	
Q304	8-729-424-02	TRANSISTOR	2SB709A-QRS-TX		(KV-21FM120 ONLY)			
Q305	8-729-424-02	TRANSISTOR	2SB709A-QRS-TX	Q601	8-729-053-36	TRANSISTOR	2SK2640-01MR-F122	
Q306	8-729-424-02	TRANSISTOR	2SB709A-QRS-TX		(ALL EXCEPT KV-21FM120)			
Q316	8-729-422-27	TRANSISTOR	2SD601A-Q	Q601	8-729-052-29	TRANSISTOR	2SK2876-01MR-F122	
Q390	8-729-422-27	TRANSISTOR	2SD601A-Q		(KV-21FM120 ONLY)			
Q391	8-729-422-27	TRANSISTOR	2SD601A-Q	Q604	8-729-424-02	TRANSISTOR	2SB709A-QRS-TX	
Q400	8-729-422-27	TRANSISTOR	2SD601A-Q	Q608	8-729-922-37	TRANSISTOR	2SD2144S-UVW	
	(KV-21FA310LN/21FA310LS ONLY)			Q650	6-550-409-01	TRANSISTOR	KSC2383-O	
Q401	8-729-422-27	TRANSISTOR	2SD601A-Q	Q860	8-729-422-27	TRANSISTOR	2SD601A-Q	
	(KV-21FA310LN/21FA310LS ONLY)			RESISTOR				
Q403	8-729-422-27	TRANSISTOR	2SD601A-Q	R002	1-216-864-11	SHORT CHIP		
	(KV-21FA310LN/21FA310LS ONLY)			R003	1-216-821-11	METAL CHIP	1K 5% 1/10W	
Q404	8-729-422-27	TRANSISTOR	2SD601A-Q	R004	1-216-817-11	METAL CHIP	470 5% 1/10W	
	(KV-21FA310LN/21FA310LS ONLY)			R005	1-400-427-21	FERRITE	0µH	
Q404	8-729-422-27	TRANSISTOR	2SD601A-Q	R006	1-216-829-11	METAL CHIP	4.7K 5% 1/10W	
Q411	8-729-422-27	TRANSISTOR	2SD601A-Q	R007	1-400-427-21	FERRITE	0µH	
				R015	1-216-833-11	METAL CHIP	10K 5% 1/10W	
				R027	1-218-732-11	METAL CHIP	47K 0.50% 1/10W	



REF. NO.	PART NO.	DESCRIPTION	VALUES			REF. NO.	PART NO.	DESCRIPTION	VALUES		
R028	1-249-409-11	CARBON	220	5%	1/4W	R071	1-249-427-11	CARBON	6.8K	5%	1/4W
R029	1-249-409-11	CARBON (ALL EXCEPT KV-21FM120)	220	5%	1/4W		(KV-21FA310LN/21FA310LS ONLY)				
R030	1-249-409-11	CARBON (ALL EXCEPT KV-21FM120)	220	5%	1/4W	R072	1-249-425-11	CARBON	4.7K	5%	1/4W
R031	1-216-813-11	METAL CHIP	220	5%	1/10W	R073	1-249-419-11	CARBON (KV-21FA310LN/21FA310LS ONLY)	1.5K	5%	1/4W
R032	1-216-813-11	METAL CHIP (ALL EXCEPT KV-21FM120)	220	5%	1/10W	R074	1-249-421-11	CARBON (KV-21FA310LN/21FA310LS ONLY)	2.2K	5%	1/4W
R033	1-249-409-11	CARBON	220	5%	1/4W	R075	1-249-427-11	CARBON (KV-21FA310LN/21FA310LS ONLY)	6.8K	5%	1/4W
R035	1-216-809-11	METAL CHIP	100	5%	1/10W	R076	1-247-807-31	CARBON	100	5%	1/4W
R037	1-216-833-11	METAL CHIP	10K	5%	1/10W	R080	1-216-833-11	METAL CHIP	10K	5%	1/10W
R038	1-216-821-11	METAL CHIP	1K	5%	1/10W	R081	1-216-841-11	METAL CHIP	47K	5%	1/10W
R039	1-216-815-11	METAL CHIP	330	5%	1/10W	R082	1-216-857-11	METAL CHIP	1M	5%	1/10W
R040	1-216-829-11	METAL CHIP	4.7K	5%	1/10W	R083	1-216-847-11	METAL CHIP	150K	5%	1/10W
R041	1-216-829-11	METAL CHIP	4.7K	5%	1/10W	R084	1-216-819-11	METAL CHIP	680	5%	1/10W
R042	1-216-813-11	METAL CHIP	220	5%	1/10W	R085	1-216-864-11	SHORT CHIP			
R043	1-216-813-11	METAL CHIP	220	5%	1/10W	R086	1-216-821-11	METAL CHIP	1K	5%	1/10W
R044	1-216-829-11	METAL CHIP	4.7K	5%	1/10W	R087	1-247-807-31	CARBON	100	5%	1/4W
R045	1-216-829-11	METAL CHIP	4.7K	5%	1/10W	R088	1-216-864-11	SHORT CHIP			
R047	1-249-409-11	CARBON	220	5%	1/4W	R090	1-216-837-11	METAL CHIP	22K	5%	1/10W
R048	1-216-829-11	METAL CHIP	4.7K	5%	1/10W	R091	1-216-841-11	METAL CHIP	47K	5%	1/10W
R049	1-216-829-11	METAL CHIP	4.7K	5%	1/10W	R092	1-216-825-11	METAL CHIP	2.2K	5%	1/10W
R050	1-249-425-11	CARBON	4.7K	5%	1/4W	R093	1-216-841-11	METAL CHIP	47K	5%	1/10W
R051	1-249-417-11	CARBON	1K	5%	1/4W	R094	1-414-229-11	FERRITE	0μH		
R052	1-216-813-11	METAL CHIP	220	5%	1/10W	R095	1-216-813-11	METAL CHIP	220	5%	1/10W
R053	1-249-433-11	CARBON	22K	5%	1/4W	R096	1-216-829-11	METAL CHIP	4.7K	5%	1/10W
R054	1-249-433-11	CARBON	22K	5%	1/4W	R098	1-216-839-11	METAL CHIP (ALL EXCEPT KV-21FM120)	33K	5%	1/10W
R055	1-216-829-11	METAL CHIP	4.7K	5%	1/10W	R098	1-216-837-11	METAL CHIP (KV-21FM120 ONLY)	22K	5%	1/10W
R056	1-216-833-11	METAL CHIP	10K	5%	1/10W						
R057	1-249-417-11	CARBON	1K	5%	1/4W	R101	1-216-829-11	METAL CHIP (ALL EXCEPT KV-21FM120)	4.7K	5%	1/10W
R058	1-249-429-11	CARBON	10K	5%	1/4W		(ALL EXCEPT KV-21FM120)				
R059	1-249-417-11	CARBON	1K	5%	1/4W	R101	1-216-832-11	METAL CHIP (KV-21FM120 ONLY)	8.2K	5%	1/10W
R060	1-249-409-11	CARBON (ALL EXCEPT KV-21FM120)	220	5%	1/4W	R102	1-216-837-11	METAL CHIP	22K	5%	1/10W
R061	1-249-429-11	CARBON	10K	5%	1/4W						
R062	1-249-413-11	CARBON	470	5%	1/4W	R103	1-216-833-11	METAL CHIP	10K	5%	1/10W
R063	1-216-829-11	METAL CHIP	4.7K	5%	1/10W	R104	1-216-864-11	SHORT CHIP (KV-21FM120 ONLY)			
R065	1-249-415-11	CARBON (KV-21FA310LN/21FA310LS ONLY)	680	5%	1/4W	R105	1-216-864-11	SHORT CHIP (ALL EXCEPT KV-21FM120)			
R067	1-249-416-11	CARBON (KV-21FA310LN/21FA310LS ONLY)	820	5%	1/4W						
R069	1-249-421-11	CARBON (KV-21FA310LN/21FA310LS ONLY)	2.2K	5%	1/4W	R106	1-216-864-11	SHORT CHIP (KV-21FM120 ONLY)			
R070	1-249-409-11	CARBON	220	5%	1/4W	R107	1-414-229-11	FERRITE	0μH		
						R108	1-414-229-11	FERRITE	0μH		



REF. NO.	PART NO.	DESCRIPTION	VALUES			REF. NO.	PART NO.	DESCRIPTION	VALUES		
R109	1-216-829-11	METAL CHIP (ALL EXCEPT KV-21FM120)	4.7K	5%	1/10W	R303	1-216-863-11	METAL CHIP (ALL EXCEPT KV-21FM120)	3.3M	5%	1/10W
R110	1-249-409-11	CARBON	220	5%	1/4W	R305	1-218-285-11	METAL CHIP (ALL EXCEPT KV-21FM120)	75	5%	1/10W
R111	1-216-829-11	METAL CHIP (ALL EXCEPT KV-21FM120)	4.7K	5%	1/10W	R305	1-216-864-11	SHORT CHIP (KV-21FM120 ONLY)			
R112	1-249-425-11	CARBON	4.7K	5%	1/4W	R308	1-216-821-11	METAL CHIP	1K	5%	1/10W
R115	1-216-817-11	METAL CHIP	470	5%	1/10W	R309	1-216-833-11	METAL CHIP	10K	5%	1/10W
R116	1-216-853-11	METAL CHIP	470K	5%	1/10W	R310	1-216-821-11	METAL CHIP	1K	5%	1/10W
R200	1-216-813-11	METAL CHIP	220	5%	1/10W	R311	1-216-813-11	METAL CHIP	220	5%	1/10W
R202	1-216-845-11	METAL CHIP	100K	5%	1/10W	R312	1-218-867-11	METAL CHIP	6.8K	0.50%	1/10W
R203	1-216-845-11	METAL CHIP	100K	5%	1/10W	R313	1-216-864-11	SHORT CHIP			
R206	1-216-845-11	METAL CHIP (KV-21FA310LN/21FA310LS ONLY)	100K	5%	1/10W	R314	1-216-833-11	METAL CHIP	10K	5%	1/10W
R207	1-216-845-11	METAL CHIP (KV-21FA310LN/21FA310LS ONLY)	100K	5%	1/10W	R315	1-216-813-11	METAL CHIP	220	5%	1/10W
R208	1-249-409-11	CARBON (KV-21FA310LN/21FA310LS ONLY)	220	5%	1/4W	R316	1-216-825-11	METAL CHIP	2.2K	5%	1/10W
R209	1-249-409-11	CARBON (KV-21FA310LN/21FA310LS ONLY)	220	5%	1/4W	R317	1-216-813-11	METAL CHIP	220	5%	1/10W
R215	1-216-853-11	METAL CHIP (KV-21FA310LN/21FA310LS ONLY)	470K	5%	1/10W	R318	1-216-825-11	METAL CHIP	2.2K	5%	1/10W
R216	1-216-853-11	METAL CHIP (KV-21FA310LN/21FA310LS ONLY)	470K	5%	1/10W	R319	1-216-813-11	METAL CHIP	220	5%	1/10W
R217	1-249-409-11	CARBON (KV-21FA310LN/21FA310LS ONLY)	220	5%	1/4W	R320	1-216-825-11	METAL CHIP	2.2K	5%	1/10W
R218	1-216-813-11	METAL CHIP	220	5%	1/10W	R321	1-247-807-31	CARBON	100	5%	1/4W
R220	1-216-813-11	METAL CHIP	220	5%	1/10W	R322	1-218-684-11	METAL CHIP	470	0.50%	1/10W
R221	1-249-409-11	CARBON	220	5%	1/4W	R323	1-215-415-00	METAL	560	1%	1/4W
R222	1-249-409-11	CARBON	220	5%	1/4W	R324	1-216-821-11	METAL CHIP	1K	5%	1/10W
R226	1-218-285-11	METAL CHIP (KV-21FA310LN/21FA310LS ONLY)	75	5%	1/10W	R325	1-216-864-11	SHORT CHIP			
R227	1-218-285-11	METAL CHIP (KV-21FA310LN/21FA310LS/24FS120/25FS120LN/25FS120LS ONLY)	75	5%	1/10W	R326	1-400-427-21	FERRITE	0μH		
R229	1-218-285-11	METAL CHIP (KV-21FA310LN/21FA310LS/24FS120/25FS120LN/25FS120LS ONLY)	75	5%	1/10W	R328	1-400-427-21	FERRITE	0μH		
R230	1-218-285-11	METAL CHIP	75	5%	1/10W	R335	1-216-813-11	METAL CHIP	220	5%	1/10W
R234	1-216-864-11	SHORT CHIP (KV-21FM120 ONLY)				R337	1-216-801-11	METAL CHIP	22	5%	1/10W
R250	1-216-821-11	METAL CHIP	1K	5%	1/10W	R338	1-216-864-11	SHORT CHIP			
R251	1-216-821-11	METAL CHIP	1K	5%	1/10W	R351	1-216-829-11	METAL CHIP	4.7K	5%	1/10W
R301	1-216-864-11	SHORT CHIP (KV-20FS120/21FS12LN/21FM120/21FS120LS ONLY)				R352	1-216-853-11	METAL CHIP	470K	5%	1/10W
R302	1-216-864-11	SHORT CHIP (KV-20FS120/21FS12LN/21FM120/21FS120LS ONLY)				R363	1-218-285-11	METAL CHIP (ALL EXCEPT KV-21FM120)	75	5%	1/10W
						R363	1-216-864-11	SHORT CHIP (KV-21FM120 ONLY)			
						R364	1-218-285-11	METAL CHIP (ALL EXCEPT KV-21FM120)	75	5%	1/10W
						R364	1-216-864-11	SHORT CHIP (KV-21FM120 ONLY)			
						R370	1-216-825-11	METAL CHIP	2.2K	5%	1/10W
						R371	1-216-849-11	METAL CHIP	220K	5%	1/10W
						R372	1-216-827-11	METAL CHIP	3.3K	5%	1/10W
						R382	1-216-863-11	METAL CHIP (ALL EXCEPT KV-21FM120)	3.3M	5%	1/10W







REF. NO.	PART NO.	DESCRIPTION	VALUES			REF. NO.	PART NO.	DESCRIPTION	VALUES		
R390	1-216-864-11	SHORT CHIP				R431	1-216-845-11	METAL CHIP	100K	5%	1/10W
R391	1-216-829-11	METAL CHIP	4.7K	5%	1/10W			(ALL EXCEPT KV-21FM120)			
R392	1-216-818-11	METAL CHIP	560	5%	1/10W	R433	1-216-809-11	METAL CHIP	100	5%	1/10W
R393	1-216-825-11	METAL CHIP	2.2K	5%	1/10W	R434	1-216-864-11	SHORT CHIP			
R394	1-216-833-11	METAL CHIP	10K	5%	1/10W			(KV-21FA310LN/21FA310LS ONLY)			
R400	1-216-829-11	METAL CHIP	4.7K	5%	1/10W	R434	1-216-805-11	METAL CHIP	47	5%	1/10W
		(KV-21FA310LN/21FA310LS ONLY)						(ALL EXCEPT KV-21FA310LN/21FA310LS)			
R401	1-216-809-11	METAL CHIP	100	5%	1/10W	R439	1-216-845-11	METAL CHIP	100K	5%	1/10W
R402	1-216-864-11	SHORT CHIP						(KV-21FA310LN/21FA310LS ONLY)			
		(KV-21FA310LN/21FA310LS ONLY)				R440	1-249-413-11	CARBON	470	5%	1/4W
R403	1-216-809-11	METAL CHIP	100	5%	1/10W			(KV-21FA310LN/21FA310LS ONLY)			
R404	1-216-825-11	METAL CHIP	2.2K	5%	1/10W	R441	1-249-413-11	CARBON	470	5%	1/4W
		(ALL EXCEPT KV-21FM120)						(KV-21FA310LN/21FA310LS ONLY)			
R404	1-216-829-11	METAL CHIP	4.7K	5%	1/10W	R442	1-216-809-11	METAL CHIP	100	5%	1/10W
		(KV-21FM120 ONLY)						(ALL EXCEPT KV-21FM120)			
R405	1-216-833-11	METAL CHIP	10K	5%	1/10W	R443	1-216-841-11	METAL CHIP	47K	5%	1/10W
R406	1-216-813-11	METAL CHIP	220	5%	1/10W			(KV-21FA310LN/21FA310LS ONLY)			
		(KV-21FA310LN/21FA310LS ONLY)				R450	1-249-425-11	CARBON	4.7K	5%	1/4W
R407	1-216-813-11	METAL CHIP	220	5%	1/10W	R477	1-216-819-11	METAL CHIP	680	5%	1/10W
		(KV-21FA310LN/21FA310LS ONLY)						(KV-21FA310LN/21FA310LS ONLY)			
R408	1-216-864-11	SHORT CHIP				R478	1-216-833-11	METAL CHIP	10K	5%	1/10W
R409	1-216-864-11	SHORT CHIP						(KV-21FA310LN/21FA310LS ONLY)			
R410	1-216-833-11	METAL CHIP	10K	5%	1/10W	R479	1-216-821-11	METAL CHIP	1K	5%	1/10W
R411	1-216-833-11	METAL CHIP	10K	5%	1/10W			(KV-21FA310LN/21FA310LS ONLY)			
R414	1-216-864-11	SHORT CHIP				R499	1-216-845-11	METAL CHIP	100K	5%	1/10W
		(KV-21FM120 ONLY)				R501	1-249-411-11	CARBON	330	5%	1/4W
R415	1-216-809-11	METAL CHIP	100	5%	1/10W	R502	1-249-425-11	CARBON	4.7K	5%	1/4W
		(KV-21FA310LN/21FA310LS ONLY)				R503	1-215-921-11	METAL OXIDE	4.7K	5%	3W
R416	1-216-864-11	SHORT CHIP						(ALL EXCEPT KV-24FS120/25FS120LN/25FS120LS)			
		(KV-21FM120 ONLY)				R503	1-215-919-11	METAL OXIDE	2.2K	5%	3W
R417	1-216-864-11	SHORT CHIP						(KV-24FS120/25FS120LN/25FS120LS ONLY)			
		(KV-21FA310LN/21FA310LS ONLY)				R504	1-249-425-11	CARBON	4.7K	5%	1/4W
R418	1-216-809-11	METAL CHIP	100	5%	1/10W	R507	1-216-833-11	METAL CHIP	10K	5%	1/10W
		(KV-21FA310LN/21FA310LS ONLY)				R510	1-260-320-11	CARBON	220	5%	1/2W
R421	1-216-864-11	SHORT CHIP						(ALL EXCEPT KV-24FS120/25FS120LN/25FS120LS)			
R422	1-216-833-11	METAL CHIP	10K	5%	1/10W	R510	1-260-328-11	CARBON	1K		
R423	1-216-813-11	METAL CHIP	220	5%	1/10W			(KV-24FS120/25FS120LN/25FS120LS ONLY)			
R424	1-216-841-11	METAL CHIP	47K	5%	1/10W	R512	1-215-910-00	METAL OXIDE	68	5%	3W
R425	1-216-833-11	METAL CHIP	10K	5%	1/10W			(ALL EXCEPT KV-24FS120/25FS120LN/25FS120LS)			
R427	1-216-841-11	METAL CHIP	47K	5%	1/10W	R513	1-215-913-11	METAL OXIDE	220	5%	3W
R429	1-216-841-11	METAL CHIP	47K	5%	1/10W			(ALL EXCEPT KV-24FS120/25FS120LN/25FS120LS)			
R430	1-216-845-11	METAL CHIP	100K	5%	1/10W	R513	1-215-908-00	METAL OXIDE	33	5%	3W
		(ALL EXCEPT KV-21FM120)						(KV-24FS120/25FS120LN/25FS120LS ONLY)			

NOTE: The components identified by shading and  mark are critical for safety. Replace only with part number specified.

A component identified by this  symbol indicates that it has been carefully factory-selected to satisfy regulations regarding X-ray radiation. Should replacement be required, replace only with the value originally used.









REF. NO.	PART NO.	DESCRIPTION	VALUES			REF. NO.	PART NO.	DESCRIPTION	VALUES		
R514	1-215-910-00	METAL OXIDE	68	5%	3W	R538	1-216-851-11	METAL CHIP	330K	5%	1/10W
R515	1-215-886-11	METAL OXIDE	100	5%	2W		(ALL EXCEPT KV-24FS120/25FS120LN/25FS120LS)				
		(ALL EXCEPT KV-24FS120/25FS120LN/25FS120LS)				R539	1-216-864-11	SHORT CHIP			
R515	1-215-885-00	METAL OXIDE	68			R540	1-249-429-11	CARBON	10K	5%	1/4W
		(KV-24FS120/25FS120LN/25FS120LS ONLY)				R541	1-218-720-11	METAL CHIP	15K	0.50%	1/10W
							(ALL EXCEPT KV-24FS120/25FS120LN/25FS120LS)				
R517	1-218-883-11	METAL CHIP	33K	0.50%	1/10W						
		(ALL EXCEPT KV-24FS120/25FS120LN/25FS120LS)				R541	1-218-714-11	METAL CHIP	8.2K	0.5%	1/10W
R517	1-216-837-11	METAL CHIP	22K	5%	1/10W		(KV-24FS120/25FS120LN/25FS120LS ONLY)				
		(KV-24FS120/25FS120LN/25FS120LS ONLY)				R542	1-215-445-00	METAL	10K	1%	1/4W
R518	1-216-833-11	METAL CHIP	10K	5%	1/10W	R543	1-216-351-00	METAL OXIDE	1.5	5%	1W
						R544	1-249-389-11	CARBON	4.7	5%	1/4W
R519	1-218-877-11	METAL CHIP	18K	0.50%	1/10W						
R520	1-216-833-11	METAL CHIP	10K	5%	1/10W	R545	1-215-890-11	METAL OXIDE	470	5%	2W
R521	1-216-819-11	METAL CHIP	680	5%	1/10W	R546	1-249-385-11	CARBON	2.2	5%	1/4W
R522	1-249-411-11	CARBON	330	5%	1/4W	R547	1-215-445-00	METAL	10K	1%	1/4W
R524	1-218-867-11	METAL CHIP	6.8K	0.50%	1/10W	R548	1-218-720-11	METAL CHIP	15K	0.50%	1/10W
							(ALL EXCEPT KV-24FS120/25FS120LN/25FS120LS)				
R525	1-215-861-00	METAL OXIDE	47	5%	1W						
R526	1-218-724-11	METAL CHIP	22K	0.50%	1/10W	R548	1-218-714-11	METAL CHIP	8.2K	0.5%	1/10W
R527	1-216-825-11	METAL CHIP	2.2K	5%	1/10W		(KV-24FS120/25FS120LN/25FS120LS ONLY)				
 R528	1-218-867-11	METAL CHIP	6.8K	0.50%	1/10W	R549	1-216-841-11	METAL CHIP	47K	5%	1/10W
		(ALL EXCEPT KV-24FS120/25FS120LN/25FS120LS)				R550	1-216-817-11	METAL CHIP	470	5%	1/10W
						R551	1-216-829-11	METAL CHIP	4.7K	5%	1/10W
 R528	1-218-816-11	METAL CHIP	390	5%	1/10W						
		(KV-24FS120/25FS120LN/25FS120LS ONLY)				R552	1-216-845-11	METAL CHIP	100K	5%	1/10W
							(ALL EXCEPT KV-24FS120/25FS120LN/25FS120LS)				
R529	1-218-724-11	METAL CHIP	22K	0.50%	1/10W	R553	1-216-821-11	METAL CHIP	1K	5%	1/10W
		(ALL EXCEPT KV-24FS120/25FS120LN/25FS120LS)				R554	1-216-827-11	METAL CHIP	3.3K	5%	1/10W
R529	1-218-720-11	METAL CHIP	15K	0.50%	1/10W	R555	1-216-833-11	METAL CHIP	10K	5%	1/10W
		(KV-24FS120/25FS120LN/25FS120LS ONLY)									
R530	1-218-873-11	METAL CHIP	12K	0.50%	1/10W	R556	1-216-825-11	METAL CHIP	2.2K	5%	1/10W
		(ALL EXCEPT KV-24FS120/25FS120LN/25FS120LS)				R557	1-216-825-11	METAL CHIP	2.2K	5%	1/10W
R530	1-218-708-11	METAL CHIP	4.7K	0.50%	1/10W	R559	1-216-837-11	METAL CHIP	22K	5%	1/10W
		(KV-24FS120/25FS120LN/25FS120LS ONLY)				R560	1-216-821-11	METAL CHIP	1K	5%	1/10W
R533	1-216-826-11	METAL CHIP	2.7K	5%	1/10W	R561	1-216-833-11	METAL CHIP	10K	5%	1/10W
		(ALL EXCEPT KV-24FS120/25FS120LN/25FS120LS)									
R533	1-216-833-11	METAL CHIP	10K	5%	1/10W	R562	1-249-429-11	CARBON	10K	5%	1/4W
		(KV-24FS120/25FS120LN/25FS120LS ONLY)				R563	1-218-871-11	METAL CHIP	10K	0.50%	1/10W
R534	1-218-720-11	METAL CHIP	15K	0.50%	1/10W	R564	1-218-738-11	METAL CHIP	82K	0.5%	1/10W
R535	1-216-825-11	METAL CHIP	2.2K	5%	1/10W		(KV-24FS120/25FS120LN/25FS120LS ONLY)				
		(ALL EXCEPT KV-24FS120/25FS120LN/25FS120LS)				 R565	1-218-716-11	METAL CHIP	10K	0.50%	1/10W
R535	1-216-830-11	METAL CHIP	5.6K	5%	1/10W						
		(KV-24FS120/25FS120LN/25FS120LS ONLY)				R566	1-215-469-00	METAL	100K	1%	1/4W
R536	1-216-833-11	METAL CHIP	10K	5%	1/10W	 R567	1-215-879-11	METAL OXIDE	47K	5%	1W
R537	1-216-857-11	METAL CHIP	1M	5%	1/10W						
		(ALL EXCEPT KV-24FS120/25FS120LN/25FS120LS)				R568	1-215-416-00	METAL	620	1%	1/4W
						R569	1-249-429-11	CARBON	10K	5%	1/4W
R537	1-216-849-11	METAL CHIP	220K	5%	1/10W	R570	1-218-716-11	METAL CHIP	10K	0.50%	1/10W
		(KV-24FS120/25FS120LN/25FS120LS ONLY)									
						R572	1-216-829-11	METAL CHIP	4.7K	5%	1/10W
						R573	1-216-829-11	METAL CHIP	4.7K	5%	1/10W
						R574	1-216-833-11	METAL CHIP	10K	5%	1/10W

NOTE: The components identified by shading and  mark are critical for safety. Replace only with part number specified.

NOTE: Les composants identifiés par un trame et une  sont critiques pour la sécurité. Ne les remplacer que par une pièce portant le numéro spécifique.



















REF. NO.	PART NO.	DESCRIPTION	VALUES			REF. NO.	PART NO.	DESCRIPTION	VALUES		
R575	1-249-389-11	CARBON	4.7	5%	1/4W	R613	1-202-961-11	CEMENTED	1.8	5%	10W
R578	1-249-429-11	CARBON	10K	5%	1/4W			(ALL EXCEPT KV-21FA310LS/21FS120LS/25FS120LS)			
R580	1-216-837-11	METAL CHIP	22K	5%	1/10W	R613	1-244-206-11	CEMENTED	2.2	5%	10W
R581	1-249-441-11	CARBON	100K	5%	1/4W			(KV-21FA310LS/21FS120LS/25FS120LS ONLY)			
R583	1-249-377-11	CARBON	0.47	5%	1/4W	R614	1-216-825-11	METAL CHIP	2.2K	5%	1/10W
R584	1-215-453-00	METAL	22K	1%	1/4W	 R615	1-202-933-61	FUSIBLE	0.1	10%	1/2W
R585	1-215-453-00	METAL	22K	1%	1/4W	R616	1-216-821-11	METAL CHIP	1K	5%	1/10W
		(ALL EXCEPT KV-24FS120/25FS120LN/25FS120LS)				R617	1-216-821-11	METAL CHIP	1K	5%	1/10W
R585	1-215-449-00	METAL	15K	1%	1/4W	R619	1-249-389-11	CARBON	4.7	5%	1/4W
		(KV-24FS120/25FS120LN/25FS120LS ONLY)				R620	1-216-353-00	METAL OXIDE	2.2	5%	1W
R586	1-218-855-11	METAL CHIP	2.2K	0.50%	1/10W	R625	1-249-413-11	CARBON	470	5%	1/4W
R587	1-249-401-11	CARBON	47	5%	1/4W	R626	1-218-716-11	METAL CHIP	10K	0.50%	1/10W
R588	1-215-882-00	METAL OXIDE	22	5%	2W	R627	1-215-481-00	METAL	330K	1%	1/4W
R589	1-247-895-91	CARBON	470K	5%	1/4W	R628	1-260-131-11	CEMENTED	470K	5%	1/2W
R590	1-249-429-11	CARBON	10K	5%	1/4W			(KV-21FA310LS/21FS120LS/25FS120LS ONLY)			
R591	1-216-365-00	METAL OXIDE	0.47	5%	2W	R629	1-215-481-00	METAL	330K	1%	1/4W
R592	1-249-441-11	CARBON	100K	5%	1/4W	R630	1-215-481-00	METAL	330K	1%	1/4W
R593	1-249-429-11	CARBON	10K	5%	1/4W	R631	1-218-718-11	METAL CHIP	12K	0.50%	1/10W
 R594	1-249-417-11	CARBON	1K	5%	1/4W	R632	1-216-809-11	METAL CHIP	100	5%	1/10W
		(ALL EXCEPT KV-24FS120/25FS120LN/25FS120LS)				R634	1-215-905-11	METAL OXIDE	10	5%	3W
 R594	1-249-418-11	CARBON	1.2K	5%	1/4W	R640	1-249-417-11	CARBON	1K	5%	1/4W
		(KV-24FS120/25FS120LN/25FS120LS ONLY)				R641	1-240-262-11	CEMENTED	0.68	5%	10W
R595	1-247-895-91	CARBON	470K	5%	1/4W			(KV-21FA310LN/20FS120/21FS120LN/24FS120/25FS120LN ONLY)			
R596	1-249-377-11	CARBON	0.47	5%	1/4W	R641	1-244-206-11	CEMENTED	2.2	5%	10W
R597	1-216-849-11	METAL CHIP	220K	5%	1/10W			(KV-21FA310LS/21FS120LS/25FS120LS ONLY)			
R598	1-249-377-11	CARBON	0.47	5%	1/4W	R641	1-205-998-11	CEMENTED	1	5%	10W
R599	1-216-837-11	METAL CHIP	22K	5%	1/10W			(KV-21FM120 ONLY)			
 R603	1-219-513-11	METAL	4.7M	5%	1/2W	R647	1-216-811-11	METAL CHIP	150	5%	1/10W
		(ALL EXCEPT KV-21FA310LS/21FS120LS/25FS120LS)				R650	1-249-415-11	CARBON	680	5%	1/4W
R604	1-216-821-11	METAL CHIP	1K	5%	1/10W	R651	1-249-441-11	CARBON	100K	5%	1/4W
R605	1-216-833-11	METAL CHIP	10K	5%	1/10W	R652	1-249-441-11	CARBON	100K	5%	1/4W
R606	1-216-833-11	METAL CHIP	10K	5%	1/10W	R658	1-249-393-11	CARBON	10	5%	1/4W
R607	1-216-857-11	METAL CHIP	1M	5%	1/10W	R659	1-249-393-11	CARBON	10	5%	1/4W
R608	1-215-924-00	METAL OXIDE	15K	5%	3W	R660	1-216-833-11	METAL CHIP	10K	5%	1/10W
R609	1-245-670-11	CEMENT RESISTOR	4.7			R667	1-216-833-11	METAL CHIP	10K	5%	1/10W
		(KV-21FA310LN/21FA310LS ONLY)				 R668	1-249-418-11	CARBON	1.2K	5%	1/4W
R609	1-202-962-11	CEMENT RESISTOR	3.3	5%	10W	R670	1-216-833-11	METAL CHIP	10K	5%	1/10W
		(ALL EXCEPT KV-21FA310LN/21FA310LS)				R671	1-243-979-71	METAL OXIDE	0.1	5%	2W
R611	1-202-961-11	CEMENTED	1.8	5%	10W	 R699	1-218-265-11	METAL CHIP	8.2M	5%	1W
		(ALL EXCEPT KV-21FA310LS/21FS120LS/25FS120LS)						(KV-21FA310LS/21FS120LS/25FS120LS ONLY)			
R611	1-244-206-11	CEMENTED	2.2	5%	10W	R680	1-216-864-11	SHORT CHIP			
		(KV-21FA310LS/21FS120LS/25FS120LS ONLY)				R801	1-218-716-11	METAL CHIP	10K	0.50%	1/10W
R612	1-260-131-11	CEMENTED	470K	5%	1/2W	R802	1-218-877-11	METAL CHIP	18K	0.50%	1/10W
		(KV-21FA310LS/21FS120LS/25FS120LS ONLY)						(ALL EXCEPT KV-24FS120/25FS120LN/25FS120LS)			

NOTE: The components identified by shading and  mark are critical for safety. Replace only with part number specified.

NOTE: Les composants identifiés par un trame et une  sont critiques pour la sécurité. Ne les remplacer que par une pièce portant le numéro spécifique.



REF. NO.	PART NO.	DESCRIPTION	VALUES			REF. NO.	PART NO.	DESCRIPTION	VALUES		
R802	1-218-871-11	METAL CHIP (KV-24FS120/25FS120LN/25FS120LS ONLY)	10K	0.50%	1/10W		T511	1-435-079-21	TRANSFORMER, HORIZONTAL LINEAR (ALL EXCEPT KV-24FS120/25FS120LN/25FS120LS)		
R803	1-218-719-11	METAL CHIP	13K	0.50%	1/10W		T511	1-433-850-11	TRANSFORMER, HORIZONTAL LINEAR (KV-24FS120/25FS120LN/25FS120LS ONLY)		
R804	1-249-435-11	CARBON	33K	5%	1/4W		T585	1-453-316-21	FBT ASSY NX-1748//X4A4 (ALL EXCEPT KV-24FS120/25FS120LN/25FS120LS)		
R812	1-218-716-11	METAL CHIP	10K	0.50%	1/10W						
R813	1-218-716-11	METAL CHIP	10K	0.50%	1/10W						
R814	1-218-736-11	METAL CHIP	68K	0.50%	1/10W		T585	1-453-336-11	FBT ASSY NX-4011//X4A4 (KV-24FS120/25FS120LN/25FS120LS ONLY)		
R815	1-218-732-11	METAL CHIP	47K	0.50%	1/10W		T601	1-435-617-11	TRANSFORMER, LINE FILTER		
R850	1-215-453-00	METAL	22K	1%	1/4W		T602	1-435-675-11	TRANSFORMER, STANDBY (ALL EXCEPT KV-21FA310LS/21FS120LS/25FS120LS)		
R851	1-216-821-11	METAL CHIP	1K	5%	1/10W						
R852	1-218-869-11	METAL CHIP (ALL EXCEPT KV-24FS120/25FS120LN/25FS120LS)	8.2K	0.50%	1/10W		T602	1-435-676-11	TRANSFORMER, STANDBY (KV-21FA310LS/21FS120LS/25FS120LS ONLY)		
R860	1-216-833-11	METAL CHIP	10K	5%	1/10W		T603	1-439-898-21	CONVERTER TRANSFORMER (ALL EXCEPT KV-21FM120)		
R861	1-216-833-11	METAL CHIP	10K	5%	1/10W		T603	1-437-609-11	CONVERTER TRANSFORMER (KV-21FM120 ONLY)		
R862	1-216-813-11	METAL CHIP	220	5%	1/10W						
R893	1-216-864-11	SHORT CHIP									
RELAY											
	RY501	1-755-198-11	RELAY, AC POWER								
	RY600	1-755-395-11	RELAY (AC POWER)								
SWITCH											
S002	1-692-431-21	SWITCH, TACTILE (KV-21FA310LN/21FA310LS ONLY)									
S003	1-692-431-21	SWITCH, TACTILE (KV-21FA310LN/21FA310LS ONLY)									
S004	1-692-431-21	SWITCH, TACTILE (KV-21FA310LN/21FA310LS ONLY)									
S005	1-692-431-21	SWITCH, TACTILE (KV-21FA310LN/21FA310LS ONLY)									
S006	1-692-431-21	SWITCH, TACTILE (KV-21FA310LN/21FA310LS ONLY)									
S007	1-762-816-11	SWITCH, TACTILE (KV-21FA310LN/21FA310LS ONLY)									
S008	1-762-816-11	SWITCH, TACTILE (KV-21FA310LN/21FA310LS ONLY)									
SW515	1-572-707-11	SWITCH, LEVER									
TRANSFORMER											
T505	1-433-836-11	TRANSFORMER, HORIZONTAL DRIVE									
T510	1-437-610-11	TRANSFORMER, FERRITE (KV-24FS120/25FS120LN/25FS120LS ONLY)									
THERMISTOR											
	THP501	1-809-539-11	THERMISTOR, POSITIVE (ALL EXCEPT KV-21FA310LS/21FS120LS/25FS120LS)								
	THP501	1-809-540-11	THERMISTOR, POSITIVE (KV-21FA310LS/21FS120LS/25FS120LS ONLY)								
TUNER											
	TU101	8-598-593-50	TUNER, FSS BTF-WA421 (ALL EXCEPT KV-21FM120)								
	TU101	8-598-594-30	TUNER, FSS BTF-FA421 (KV-21FM120 ONLY)								
VARISTOR											
	VDR600	1-810-974-21	VARISTOR (ALL EXCEPT KV-21FA310LS/21FS120LS/25FS120LS)								
	VDR600	1-803-967-11	VARISTOR (KV-21FA310LS/21FS120LS/25FS120LS ONLY)								
CRYSTAL											
X001	1-795-006-21	VIBRATOR, CRYSTAL									
X301	1-781-377-21	VIBRATOR, CRYSTAL									

NOTE: The components identified by shading and \triangle mark are critical for safety. Replace only with part number specified.

NOTE: Les composants identifiés par un trame et une marque \triangle sont critiques pour la sécurité. Ne les remplacer que par une pièce portant le numéro spécifié.



REF. NO.	PART NO.	DESCRIPTION	VALUES			REF. NO.	PART NO.	DESCRIPTION	VALUES		
Q783	8-729-422-27	TRANSISTOR	2SD601A-Q			R911	1-216-799-11	METAL CHIP	15	5%	1/10W
Q901	8-729-053-87	TRANSISTOR	KTC4370A			R912	1-216-813-11	METAL CHIP	220	5%	1/10W
Q902	6-550-247-01	TRANSISTOR	KTA1659A			R913	1-216-799-11	METAL CHIP	15	5%	1/10W
Q903	8-729-422-27	TRANSISTOR	2SD601A-Q			R914	1-216-814-11	METAL CHIP	270	5%	1/10W
Q904	8-729-422-27	TRANSISTOR	2SD601A-Q			R915	1-216-821-11	METAL CHIP	1K	5%	1/10W
Q905	8-729-424-02	TRANSISTOR	2SB709A-QRS-TX			R916	1-216-821-11	METAL CHIP	1K	5%	1/10W
Q906	8-729-422-27	TRANSISTOR	2SD601A-Q			R917	1-216-821-11	METAL CHIP	1K	5%	1/10W
Q1772	8-729-422-27	TRANSISTOR	2SD601A-Q			R918	1-216-809-11	METAL CHIP	100	5%	1/10W
RESISTOR											
R760	1-216-829-11	METAL CHIP	4.7K	5%	1/10W	R920	1-216-820-11	METAL CHIP	820	5%	1/10W
R762	1-218-692-11	METAL CHIP	1K	0.50%	1/10W	R921	1-216-833-11	METAL CHIP	10K	5%	1/10W
R763	1-216-835-11	METAL CHIP	15K	5%	1/10W	R922	1-249-397-11	CARBON	22	5%	1/4W
R764	1-218-678-11	METAL CHIP	270	0.50%	1/10W	R923	1-249-401-11	CARBON	47	5%	1/4W
R765	1-218-700-11	METAL CHIP	2.2K	0.50%	1/10W	R1756	1-260-328-11	CARBON	1K	5%	1/2W
R766	1-216-827-11	METAL CHIP	3.3K	5%	1/10W	R1757	1-260-328-11	CARBON	1K	5%	1/2W
R767	1-216-830-11	METAL CHIP	5.6K	5%	1/10W	R1758	1-260-328-11	CARBON	1K	5%	1/2W
R768	1-216-821-11	METAL CHIP	1K	5%	1/10W	R1760	1-260-123-11	CARBON	100K	5%	1/2W
R770	1-216-829-11	METAL CHIP	4.7K	5%	1/10W	R1761	1-216-373-11	METAL OXIDE	2.2	5%	2W
R772	1-218-692-11	METAL CHIP	1K	0.50%	1/10W	R1761	1-216-395-00	METAL OXIDE	3.3	5%	3W
R773	1-216-835-11	METAL CHIP	15K	5%	1/10W	(KV-20FS120/21FA310LN/21FA310LS/21FM120/21FS120LN/21FS120LS ONLY)					
R774	1-218-678-11	METAL CHIP	270	0.50%	1/10W	R1761	1-216-373-11	METAL OXIDE	2.2		2W
R775	1-218-700-11	METAL CHIP	2.2K	0.50%	1/10W	(KV-24FS120/25FS120LN/25FS120LS ONLY)					
R776	1-216-827-11	METAL CHIP	3.3K	5%	1/10W	R1762	1-216-375-00	METAL OXIDE	3.3	5%	2W
R777	1-216-830-11	METAL CHIP	5.6K	5%	1/10W	(KV-24FS120/25FS120LN/25FS120LS ONLY)					
R778	1-216-821-11	METAL CHIP	1K	5%	1/10W	R1763	1-247-807-31	CARBON	100	5%	1/4W
R780	1-216-829-11	METAL CHIP	4.7K	5%	1/10W	R1764	1-247-807-31	CARBON	100	5%	1/4W
R782	1-218-692-11	METAL CHIP	1K	0.50%	1/10W	R1765	1-247-807-31	CARBON	100	5%	1/4W
R783	1-216-835-11	METAL CHIP	15K	5%	1/10W	R1766	1-247-807-31	CARBON	100	5%	1/4W
R784	1-218-678-11	METAL CHIP	270	0.50%	1/10W	R1767	1-247-807-31	CARBON	100	5%	1/4W
R785	1-218-700-11	METAL CHIP	2.2K	0.50%	1/10W	R1768	1-247-807-31	CARBON	100	5%	1/4W
R786	1-216-827-11	METAL CHIP	3.3K	5%	1/10W	R1770	1-260-132-11	CARBON	560K	5%	1/2W
R787	1-216-830-11	METAL CHIP	5.6K	5%	1/10W	R1778	1-216-833-11	METAL CHIP	10K	5%	1/10W
R788	1-216-821-11	METAL CHIP	1K	5%	1/10W	R1779	1-247-791-91	CARBON	22	5%	1/4W
R901	1-249-401-11	CARBON	47	5%	1/4W	(KV-24FS120/25FS120LN/25FS120LS ONLY)					
R902	1-249-386-11	CARBON	2.7	5%	1/4W	R1780	1-216-837-11	METAL CHIP	22K	5%	1/10W
R903	1-249-414-11	CARBON	560	5%	1/4W	R1781	1-216-838-11	METAL CHIP	27K	5%	1/10W
R904	1-249-432-11	CARBON	18K	5%	1/4W	R1785	1-249-399-11	CARBON	33	5%	1/4W
R905	1-249-417-11	CARBON	1K	5%	1/4W	R1787	1-216-837-11	METAL CHIP	22K	5%	1/10W
R906	1-249-432-11	CARBON	18K	5%	1/4W	R1788	1-249-421-11	CARBON	2.2K	5%	1/4W
R907	1-249-386-11	CARBON	2.7	5%	1/4W	R1789	1-249-425-11	CARBON	4.7K	5%	1/4W
R908	1-249-414-11	CARBON	560	5%	1/4W	VARIABLE RESISTOR					
R909	1-260-312-11	CARBON	47	5%	1/2W	RV1701	1-238-019-11	RES, ADJ, METAL FILM	47K		
R910	1-216-476-11	METAL OXIDE	180	5%	3W	\triangle RV1750	1-241-656-11	RES, ADJ, METAL FILM	110M		



REF. NO.	PART NO.	DESCRIPTION	VALUES			REF. NO.	PART NO.	DESCRIPTION	VALUES		
*	A-1410-921-A	K BOARD, MOUNTED									
		(KV-21FA310 only)									
	4-382-854-11	SCREW (M3X10), P, SW (+)									
	CAPACITOR										
C2401	1-130-495-00	MYLAR	0.1μF	5%	50V	C2437	1-107-826-11	CERAMIC CHIP	0.1μF	10%	16V
C2402	1-130-495-00	MYLAR	0.1μF	5%	50V	C2438	1-164-227-11	CERAMIC CHIP	0.022μF	10%	25V
C2403	1-126-964-11	ELECT	10μF	20%	50V	C2439	1-164-227-11	CERAMIC CHIP	0.022μF	10%	25V
C2404	1-162-968-11	CERAMIC CHIP	0.0047μF	10%	50V	C2440	1-107-826-11	CERAMIC CHIP	0.1μF	10%	16V
C2405	1-126-965-91	ELECT	22μF	20%	50V	C2441	1-115-412-11	CERAMIC CHIP	680pF	5%	25V
C2406	1-126-964-11	ELECT	10μF	20%	50V	C2442	1-165-176-11	CERAMIC CHIP	0.047μF	10%	16V
C2407	1-126-964-11	ELECT	10μF	20%	50V	C2443	1-115-412-11	CERAMIC CHIP	680pF	5%	25V
C2408	1-162-969-11	CERAMIC CHIP	0.0068μF	10%	25V	C2444	1-165-176-11	CERAMIC CHIP	0.047μF	10%	16V
C2410	1-126-969-11	ELECT	220μF	20%	50V	C2445	1-126-965-91	ELECT	22μF	20%	50V
C2411	1-126-965-91	ELECT	22μF	20%	50V	C2446	1-130-495-00	MYLAR	0.1μF	5%	50V
C2412	1-137-194-81	FILM	0.47μF	5%	50V	C2447	1-130-495-00	MYLAR	0.1μF	5%	50V
C2413	1-100-120-51	ELECT	1000μF	20%	35V	C2448	1-137-190-91	FILM	0.22μF	5%	50V
C2414	1-126-963-11	ELECT	4.7μF	20%	50V	C2449	1-165-176-11	CERAMIC CHIP	0.047μF	10%	16V
C2415	1-126-967-11	ELECT	47μF	20%	50V	C2450	1-126-963-11	ELECT	4.7μF	20%	50V
C2416	1-164-172-11	CERAMIC CHIP	0.0056μF	10%	25V	C2451	1-162-967-11	CERAMIC CHIP	0.0033μF	10%	50V
C2417	1-162-968-11	CERAMIC CHIP	0.0047μF	10%	50V	C2452	1-164-677-11	CERAMIC CHIP	0.033μF	10%	16V
C2418	1-125-891-11	CERAMIC CHIP	0.47μF	10%	10V	C2453	1-162-968-11	CERAMIC CHIP	0.0047μF	10%	50V
C2419	1-127-715-91	CERAMIC CHIP	0.22μF	10%	16V	C2454	1-107-826-11	CERAMIC CHIP	0.1μF	10%	16V
C2420	1-126-959-11	ELECT	0.47μF	20%	50V	C2455	1-107-826-11	CERAMIC CHIP	0.1μF	10%	16V
C2421	1-126-959-11	ELECT	0.47μF	20%	50V	C2456	1-126-963-11	ELECT	4.7μF	20%	50V
C2422	1-127-715-91	CERAMIC CHIP	0.22μF	10%	16V	C2457	1-126-963-11	ELECT	4.7μF	20%	50V
C2423	1-165-176-11	CERAMIC CHIP	0.047μF	10%	16V	C2458	1-126-963-11	ELECT	4.7μF	20%	50V
C2424	1-162-969-11	CERAMIC CHIP	0.0068μF	10%	25V	C2459	1-126-965-91	ELECT	22μF	20%	50V
C2425	1-107-826-11	CERAMIC CHIP	0.1μF	10%	16V	C2460	1-137-194-81	FILM	0.47μF	5%	50V
C2426	1-162-927-11	CERAMIC CHIP	100pF	5%	50V	C2461	1-126-963-11	ELECT	4.7μF	20%	50V
C2427	1-126-947-11	ELECT	47μF	20%	35V	C2462	1-126-963-11	ELECT	4.7μF	20%	50V
C2428	1-126-943-11	ELECT	2200μF	20%	25V	C2463	1-107-826-11	CERAMIC CHIP	0.1μF	10%	16V
C2429	1-107-826-11	CERAMIC CHIP	0.1μF	10%	16V	C2464	1-126-960-11	ELECT	1μF	20%	50V
C2430	1-126-960-11	ELECT	1μF	20%	50V	C2465	1-107-826-11	CERAMIC CHIP	0.1μF	10%	16V
C2431	1-126-963-11	ELECT	4.7μF	20%	50V	C2466	1-162-968-11	CERAMIC CHIP	0.0047μF	10%	50V
C2432	1-126-963-11	ELECT	4.7μF	20%	50V	C2467	1-164-677-11	CERAMIC CHIP	0.033μF	10%	16V
C2433	1-127-715-91	CERAMIC CHIP	0.22μF	10%	16V	C2468	1-162-967-11	CERAMIC CHIP	0.0033μF	10%	50V
C2434	1-107-826-11	CERAMIC CHIP	0.1μF	10%	16V	C2469	1-130-495-00	MYLAR	0.1μF	5%	50V
C2435	1-107-826-11	CERAMIC CHIP	0.1μF	10%	16V	C2470	1-162-968-11	CERAMIC CHIP	0.0047μF	10%	50V
C2436	1-107-826-11	CERAMIC CHIP	0.1μF	10%	16V	C2471	1-162-968-11	CERAMIC CHIP	0.0047μF	10%	50V
						C2472	1-162-970-11	CERAMIC CHIP	0.01μF	10%	25V
						C2473	1-126-964-11	ELECT	10μF	20%	50V
						C2474	1-126-964-11	ELECT	10μF	20%	50V
						C2475	1-126-968-11	ELECT	100μF	20%	50V
						C2476	1-162-970-11	CERAMIC CHIP	0.01μF	10%	25V
						C2477	1-107-826-11	CERAMIC CHIP	0.1μF	10%	16V
						C2478	1-162-968-11	CERAMIC CHIP	0.0047μF	10%	50V
						C2479	1-107-826-11	CERAMIC CHIP	0.1μF	10%	16V
						C2480	1-107-826-11	CERAMIC CHIP	0.1μF	10%	16V



REF. NO.	PART NO.	DESCRIPTION	VALUES	REF. NO.	PART NO.	DESCRIPTION	VALUES
C2481	1-162-968-11	CERAMIC CHIP	0.0047µF 10% 50V	TRANSISTOR			
C2482	1-107-826-11	CERAMIC CHIP	0.1µF 10% 16V	Q2400	8-729-120-28	TRANSISTOR	2SC1623-L5L6
C2484	1-130-495-00	MYLAR	0.1µF 5% 50V	Q2401	8-729-120-28	TRANSISTOR	2SC1623-L5L6
C2485	1-130-495-00	MYLAR	0.1µF 5% 50V	Q2410	8-729-424-02	TRANSISTOR	2SB709A-QRS-TX
C2486	1-162-970-11	CERAMIC CHIP	0.01µF 10% 25V	Q2411	8-729-424-02	TRANSISTOR	2SB709A-QRS-TX
C2487	1-127-715-91	CERAMIC CHIP	0.22µF 10% 16V	Q2412	8-729-424-02	TRANSISTOR	2SB709A-QRS-TX
C2488	1-162-968-11	CERAMIC CHIP	0.0047µF 10% 50V	Q2413	8-729-424-02	TRANSISTOR	2SB709A-QRS-TX
C2489	1-127-715-91	CERAMIC CHIP	0.22µF 10% 16V	Q2414	8-729-422-27	TRANSISTOR	2SD601A-Q
C2490	1-104-665-11	ELECT	100µF 20% 25V	Q2418	8-729-120-28	TRANSISTOR	2SC1623-L5L6
C2493	1-126-935-11	ELECT	470µF 20% 16V	Q2419	8-729-120-28	TRANSISTOR	2SC1623-L5L6
C2494	1-126-935-11	ELECT	470µF 20% 16V	RESISTOR			
C2495	1-126-935-11	ELECT	470µF 20% 16V	R2401	1-216-845-11	METAL CHIP	100K 5% 1/10W
C2496	1-126-935-11	ELECT	470µF 20% 16V	R2402	1-216-833-11	METAL CHIP	10K 5% 1/10W
C2499	1-164-315-11	CERAMIC CHIP	470pF 5% 50V	R2403	1-216-829-11	METAL CHIP	4.7K 5% 1/10W
CONNECTOR				R2404	1-216-835-11	METAL CHIP	15K 5% 1/10W
*	CN2401	1-564-510-11	PLUG, CONNECTOR 7P	R2405	1-218-895-11	METAL CHIP	100K 0.50% 1/10W
*	CN2402	1-564-508-11	PLUG, CONNECTOR 5P	R2406	1-218-714-11	METAL CHIP	8.2K 0.50% 1/10W
DIODE				R2407	1-216-835-11	METAL CHIP	15K 5% 1/10W
D2400	8-719-404-50	DIODE	MA111-TX	R2408	1-218-868-11	METAL CHIP	7.5K 0.50% 1/10W
D2401	8-719-070-60	DIODE	PDZ7.5B-115	R2409	1-216-833-11	METAL CHIP	10K 5% 1/10W
IC				R2410	1-216-835-11	METAL CHIP	15K 5% 1/10W
IC2401	6-705-054-01	IC	TDA8947J	R2411	1-216-841-11	METAL CHIP	47K 5% 1/10W
IC2402	8-759-100-96	IC	UPC4558G2	R2412	1-218-868-11	METAL CHIP	7.5K 0.50% 1/10W
IC2403	6-706-034-01	IC	NJW1164M-TE2	R2413	1-216-841-11	METAL CHIP	47K 5% 1/10W
IC2404	8-759-165-01	IC	NJM2177AFG1	R2414	1-216-835-11	METAL CHIP	15K 5% 1/10W
IC2405	8-759-686-15	IC	NJM2180M (TE2)	R2415	1-220-397-11	METAL CHIP	4.7M 5% 1/10W
CHIP CONDUCTOR				R2416	1-216-837-11	METAL CHIP	22K 5% 1/10W
JR2401	1-216-864-11	SHORT CHIP		R2417	1-216-837-11	METAL CHIP	22K 5% 1/10W
JR2402	1-216-864-11	SHORT CHIP		R2418	1-216-809-11	METAL CHIP	100 5% 1/10W
JR2410	1-216-864-11	SHORT CHIP		R2419	1-216-809-11	METAL CHIP	100 5% 1/10W
JR2411	1-216-864-11	SHORT CHIP		R2420	1-216-837-11	METAL CHIP	22K 5% 1/10W
JR2420	1-216-864-11	SHORT CHIP		R2421	1-216-837-11	METAL CHIP	22K 5% 1/10W
JR2421	1-216-864-11	SHORT CHIP		R2422	1-216-833-11	METAL CHIP	10K 5% 1/10W
IC LINK				R2423	1-216-840-11	METAL CHIP	39K 5% 1/10W
PS2401	1-576-337-21	IC LINK	2.7A 50V	R2424	1-216-840-11	METAL CHIP	39K 5% 1/10W
				R2425	1-216-840-11	METAL CHIP	39K 5% 1/10W
				R2426	1-216-817-11	METAL CHIP	470 5% 1/10W
				R2427	1-216-817-11	METAL CHIP	470 5% 1/10W
				R2428	1-216-829-11	METAL CHIP	4.7K 5% 1/10W
				R2429	1-216-829-11	METAL CHIP	4.7K 5% 1/10W
				R2430	1-216-809-11	METAL CHIP	100 5% 1/10W



REF. NO.	PART NO.	DESCRIPTION	VALUES			REF. NO.	PART NO.	DESCRIPTION	VALUES		
R2431	1-216-809-11	METAL CHIP	100	5%	1/10W	R2477	1-216-835-11	METAL CHIP	15K	5%	1/10W
R2432	1-216-864-11	SHORT CHIP				R2478	1-216-845-11	METAL CHIP	100K	5%	1/10W
R2433	1-216-833-11	METAL CHIP	10K	5%	1/10W	R2479	1-216-845-11	METAL CHIP	100K	5%	1/10W
R2434	1-218-895-11	METAL CHIP	100K	0.50%	1/10W	R2480	1-218-331-11	METAL CHIP	51K	5%	1/10W
R2435	1-216-833-11	METAL CHIP	10K	5%	1/10W	R2481	1-216-823-11	METAL CHIP	1.5K	5%	1/10W
R2436	1-216-821-11	METAL CHIP	1K	5%	1/10W	R2482	1-216-833-11	METAL CHIP	10K	5%	1/10W
R2437	1-216-833-11	METAL CHIP	10K	5%	1/10W	R2483	1-216-837-11	METAL CHIP	22K	5%	1/10W
R2438	1-216-833-11	METAL CHIP	10K	5%	1/10W	R2484	1-216-828-11	METAL CHIP	3.9K	5%	1/10W
R2439	1-216-833-11	METAL CHIP	10K	5%	1/10W	R2485	1-216-821-11	METAL CHIP	1K	5%	1/10W
R2440	1-216-837-11	METAL CHIP	22K	5%	1/10W	R2486	1-216-821-11	METAL CHIP	1K	5%	1/10W
R2441	1-216-833-11	METAL CHIP	10K	5%	1/10W	R2487	1-218-717-11	METAL CHIP	11K	0.50%	1/10W
R2442	1-216-821-11	METAL CHIP	1K	5%	1/10W	R2488	1-216-825-11	METAL CHIP	2.2K	5%	1/10W
R2443	1-216-841-11	METAL CHIP	47K	5%	1/10W	R2489	1-216-835-11	METAL CHIP	15K	5%	1/10W
R2446	1-216-833-11	METAL CHIP	10K	5%	1/10W	R2490	1-216-845-11	METAL CHIP	100K	5%	1/10W
R2447	1-216-821-11	METAL CHIP	1K	5%	1/10W	R2491	1-216-845-11	METAL CHIP	100K	5%	1/10W
R2448	1-216-845-11	METAL CHIP	100K	5%	1/10W	R2492	1-216-837-11	METAL CHIP	22K	5%	1/10W
R2449	1-216-841-11	METAL CHIP	47K	5%	1/10W	R2493	1-216-845-11	METAL CHIP	100K	5%	1/10W
R2450	1-216-833-11	METAL CHIP	10K	5%	1/10W	R2494	1-216-845-11	METAL CHIP	100K	5%	1/10W
R2451	1-216-845-11	METAL CHIP	100K	5%	1/10W	R2495	1-218-292-11	METAL CHIP	20K	5%	1/10W
R2452	1-216-821-11	METAL CHIP	1K	5%	1/10W	R2496	1-216-847-11	METAL CHIP	150K	5%	1/10W
R2453	1-216-841-11	METAL CHIP	47K	5%	1/10W	R2497	1-216-823-11	METAL CHIP	1.5K	5%	1/10W
R2454	1-216-821-11	METAL CHIP	1K	5%	1/10W	R2498	1-216-837-11	METAL CHIP	22K	5%	1/10W
R2455	1-216-809-11	METAL CHIP	100	5%	1/10W	R2499	1-216-837-11	METAL CHIP	22K	5%	1/10W
R2456	1-216-809-11	METAL CHIP	100	5%	1/10W	R2500	1-216-829-11	METAL CHIP	4.7K	5%	1/10W
R2457	1-216-864-11	SHORT CHIP				R2501	1-216-837-11	METAL CHIP	22K	5%	1/10W
R2458	1-216-861-11	METAL CHIP	2.2M	5%	1/10W	R2502	1-216-837-11	METAL CHIP	22K	5%	1/10W
R2459	1-216-853-11	METAL CHIP	470K	5%	1/10W	R2503	1-216-837-11	METAL CHIP	22K	5%	1/10W
R2460	1-218-714-11	METAL CHIP	8.2K	0.50%	1/10W	R2504	1-216-837-11	METAL CHIP	22K	5%	1/10W
R2461	1-216-839-11	METAL CHIP	33K	5%	1/10W	R2505	1-216-841-11	METAL CHIP	47K	5%	1/10W
R2462	1-218-296-11	METAL CHIP	75K	5%	1/10W	R2507	1-216-809-11	METAL CHIP	100	5%	1/10W
R2463	1-216-823-11	METAL CHIP	1.5K	5%	1/10W	R2519	1-216-821-11	METAL CHIP	1K	5%	1/10W
R2464	1-218-331-11	METAL CHIP	51K	5%	1/10W	R2520	1-216-821-11	METAL CHIP	1K	5%	1/10W
R2465	1-216-824-11	METAL CHIP	1.8K	5%	1/10W	R2521	1-216-833-11	METAL CHIP	10K	5%	1/10W
R2466	1-218-866-11	METAL CHIP	6.2K	0.50%	1/10W	R2522	1-216-841-11	METAL CHIP	47K	5%	1/10W
R2467	1-216-833-11	METAL CHIP	10K	5%	1/10W	R2523	1-216-841-11	METAL CHIP	47K	5%	1/10W
R2468	1-216-833-11	METAL CHIP	10K	5%	1/10W	R2524	1-216-864-11	SHORT CHIP			
R2469	1-216-833-11	METAL CHIP	10K	5%	1/10W						
R2470	1-216-840-11	METAL CHIP	39K	5%	1/10W						
R2471	1-216-824-11	METAL CHIP	1.8K	5%	1/10W						
R2472	1-218-331-11	METAL CHIP	51K	5%	1/10W						
R2473	1-216-861-11	METAL CHIP	2.2M	5%	1/10W						
R2474	1-216-839-11	METAL CHIP	33K	5%	1/10W						
R2475	1-218-296-11	METAL CHIP	75K	5%	1/10W						
R2476	1-216-835-11	METAL CHIP	15K	5%	1/10W						



REF. NO.	PART NO.	DESCRIPTION	VALUES	REF. NO.	PART NO.	DESCRIPTION	VALUES
HR * A-1415-629-A HR (VAR) BOARD, MOUNTED (KV-21FA310 only)				CONNECTOR			
				* CN2402	1-564-507-11	PLUG, CONNECTOR	4P
CAPACITOR C3001 1-104-665-11 ELECT 100µF 20% 25V				DIODE			
				D2001	8-719-109-89	DIODE	RD5.6ESB2
CONNECTOR * CN3001 1-564-521-11 PLUG, CONNECTOR 6P				D2002	8-719-070-80	DIODE	LNK0120022G
				D2003	8-719-109-89	DIODE	RD5.6ESB2
DIODE D3001 8-719-109-89 DIODE RD5.6ESB2 D3002 8-719-057-09 DIODE LNJ801LPDJA				D2004	8-719-109-89	DIODE	RD5.6ESB2
				D2005	8-719-109-89	DIODE	RD5.6ESB2
IC IC3001 8-742-211-20 HYB IC SBX3071-71				D2233	8-719-108-12	DIODE	RD9.1EW
				D2235	8-719-108-12	DIODE	RD9.1EW
RESISTOR R3001 1-249-417-11 CARBON 1K 5% 1/4W R3014 1-247-807-31 CARBON 100 5% 1/4W				D2236	8-719-108-12	DIODE	RD9.1EW
				FERRITE BEAD			
SWITCH S3006 1-786-338-12 SWITCH, TACTILE				FB2001	1-410-397-21	FERRITE	1.1µH
				FB2002	1-410-397-21	FERRITE	1.1µH
HB * A-1415-580-A HB (VAR) BOARD, MOUNTED (ALL EXCEPT KV-21FA310LN/21FA310LS/21FM120) * A-1415-692-A HB (VAR) BOARD, MOUNTED (KV-21FM120 ONLY)				FB2003	1-410-397-21	FERRITE	1.1µH
				FB2004	1-410-397-21	FERRITE	1.1µH
CAPACITOR C2001 1-104-665-11 ELECT 100µF 20% 25V C2234 1-126-960-11 ELECT 1µF 20% 50V C2235 1-126-960-11 ELECT 1µF 20% 50V C2401 1-126-965-91 ELECT 22µF 20% 50V C2402 1-126-965-91 ELECT 22µF 20% 50V				IC			
				IC2001	8-742-212-20	HYB IC	SBX3081-71
RESISTOR R2004 1-249-417-11 CARBON 1K 5% 1/4W R2007 1-247-807-31 CARBON 100 5% 1/4W R2008 1-249-427-11 CARBON 6.8K 5% 1/4W R2009 1-249-421-11 CARBON 2.2K 5% 1/4W R2010 1-249-416-11 CARBON 820 5% 1/4W				JACK			
				J2231	1-794-048-11	JACK, PIN	3P
RESISTOR R2011 1-249-415-11 CARBON 680 5% 1/4W R2201 1-249-419-11 CARBON 1.5K 5% 1/4W R2202 1-249-421-11 CARBON 2.2K 5% 1/4W R2203 1-249-427-11 CARBON 6.8K 5% 1/4W R2234 1-247-804-11 CARBON 75 5% 1/4W				(ALL EXCEPT KV-21FA310LN/21FA310LS/21FM120) J2231 1-580-441-41 JACK, PIN 2P (KV-21FM120 ONLY)			
				J2401	1-568-267-21	JACK	

In an effort to reduce the size of this pdf file the tiled schematics are not attached to this Service Manual. To receive a complete set of the tiled schematics for this manual please submit a request to Nita Wardlaw at nita.wardlaw@am.sony.com.

FD Trinitron
WEGA[®]

Operating Instructions

KV-20FS120
KV-24FS120

© 2004 by Sony Corporation

WARNING

To reduce the risk of fire or electric shock, do not expose the TV to rain or moisture.



This symbol is intended to alert the user to the presence of uninsulated "dangerous voltage" within the product's enclosure that may be of sufficient magnitude to constitute a risk of electric shock to persons.



This symbol is intended to alert the user to the presence of important operating and maintenance (servicing) instructions in the literature accompanying the appliance.

Note to the CATV Installer

This reminder is provided to call the CATV system installer's attention to Article 820-40 of the NEC that provides guidelines for proper grounding and, in particular, specifies that the cable ground shall be connected to the grounding system of the building as close to the point of cable entry as practical.

SAFETY PRECAUTIONS

- Operate the TV only on 120 V AC.
- One blade of the power plug is wider than the other for safety purposes and will fit into the power outlet only one way. If you are unable to insert the plug fully into the outlet, contact your dealer.
- If any liquid or solid object falls into the TV, unplug it and have it checked by qualified personnel before operating it further.

CAUTION

When using TV games, computers, and similar products with your TV, keep the brightness and contrast functions at low settings. If a fixed (non-moving) pattern is left on the screen for long periods of time at a high brightness or contrast setting, the image can be permanently imprinted onto the screen. Continuously watching the same channel can cause the imprint of station logos onto the TV screen. These types of imprints are not covered by your warranty because they are the results of misuse.



To reduce the risk of electric shock, do not use this polarized plug with an extension cord, receptacle, or other outlet unless the blades can be fully inserted to prevent blade exposure.



You are cautioned that any changes or modifications not expressly approved in this manual could void your authority to operate this equipment.

NOTIFICATION

This equipment has been tested and found to comply with the limits for a Class B digital device pursuant to Part 15 of the FCC Rules. These limits are designed to provide reasonable protection against harmful interference in a residential installation. This equipment generates, uses, and can radiate radio frequency energy and, if not installed and used in accordance with the instructions, may cause harmful interference with radio communications. However, there is no guarantee that interference will not occur in a particular installation. If this equipment does cause harmful interference to radio or television reception, which can be determined by turning the equipment off and on, the user is encouraged to try to correct the interference by one or more of the following measures:

- Reorient or relocate the receiving antennas.
- Increase the separation between the equipment and receiver.
- Connect the equipment into an outlet on a circuit different from that to which the receiver is connected.
- Consult the dealer or an experienced radio/TV technician for help.

Protecting the TV

- To prevent internal heat build-up, do not block the ventilation openings.
- Do not install the TV in a hot or humid place, or in a place subject to excessive dust or mechanical vibration.

Note on Caption Vision

This television receiver provides display of television closed captioning in accordance with § 15.119 of the FCC rules. Use of this television for other than private viewing of programs broadcast on UHF or VHF or transmitted by cable companies for the use of the general public may require authorization from the broadcaster-cable company and/or program owner.

Owner's Record

The model and serial numbers are located on the front cover of this manual and at the rear of your TV.

Trademarks and Copyrights

ENERGY STAR® is a registered mark.



As an ENERGY STAR® Partner, Sony has determined that this product or product model meets the ENERGY STAR® guidelines for energy efficiency.

WEGA®, FD Trinitron, Caption Vision and Steady Sound are registered trademarks of Sony Corporation.

IMPORTANT SAFEGUARDS

For your protection, please read these instructions completely, and keep this manual for future reference. Carefully observe and comply with all warnings, cautions and instructions placed on the set, or described in the operating instructions or service manual.

WARNING

To guard against injury, the following basic safety precautions should be observed in the installation, use, and servicing of the set.

Use

Power Sources

This set should be operated only from the type of power source indicated on the serial/model plate. If you are not sure of the type of electrical power supplied to your home, consult your dealer or local power company. For those sets designed to operate from battery power, refer to the operating instructions.



Grounding or Polarization

This set may be equipped with a polarized alternating current line plug (a plug having one blade wider than other). This plug will fit into the power outlet only one way. This is a safety feature. If you are unable to insert the plug fully into the outlet, try reversing the plug. If the plug still fails to fit, contact your electrician to replace your obsolete outlet. Do not defeat the safety purpose of the polarized plug.

For the set with a polarized AC power cord plug

This plug will fit into the power outlet only one way. This is a safety feature. If you are unable to insert the plug fully into the outlet, try reversing the plug. If the plug still fails to fit, contact your electrician to have a suitable outlet installed. Do not defeat the safety purpose of the polarized plug by forcing it in.



Alternate Warning

For the set with a three-wire grounding type AC plug

This plug will only fit into a grounding-type power outlet. This is a safety feature. If you are unable to insert the plug into the outlet, contact your electrician to have a suitable outlet installed. Do not defeat the safety purpose of the grounding plug.

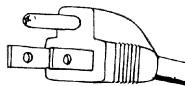

Overloading

Do not overload wall outlets, extension cords or convenience receptacles beyond their capacity, since this can result in fire or electric shock.

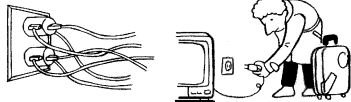

Always turn the set off when it is not to be used. When the set is left unattended and unused for long periods of time, unplug it from the wall outlet as a precaution against the possibility of an internal malfunction that could create a fire hazard.

Do not disconnect the antenna or the power cord during a heavy storm. Lightning may strike while you are holding the cable or cord, causing serious injury. Turn off your TV and wait for the weather to improve.

Object and Liquid Entry

Never push objects of any kind into the set through the cabinet slots as they may touch dangerous voltage points or short out parts that could result in a fire or electric shock. Never spill liquid of any kind on the set.



Attachments

Do not use attachments not recommended by the manufacturer, as they may cause hazards.

Do not place any objects, especially heavy objects, on top of the set. The object may fall from the set, causing injury.

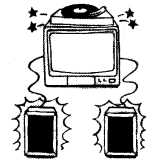

Cleaning

Unplug the set from the wall outlet before cleaning or polishing it. Do not use liquid cleaners or aerosol cleaners. Use a cloth lightly dampened with water for cleaning the exterior of the set.



If a snapping or popping sound from a TV set is continuous or frequent while the TV is operating, unplug the TV and consult your dealer or service technician. It is normal for some TV sets to make occasional snapping or popping sounds, particularly when being turned on or off.

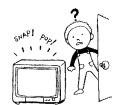

Installation

Always use two or more people to lift or move the set. The set is heavy and the bottom surface is flat. Serious injury can result from trying to move the set by yourself alone, or from unsteady handling.

Install the set on a stable, level surface.

Water and Moisture

Do not use power-line operated sets near water — for example, near a bathtub, washbowl, kitchen sink, or laundry tub, in a wet basement, or near a swimming pool, etc.

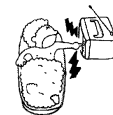

Accessories

Do not place the set on an unstable cart, stand, tripod, bracket, table, or shelf. The set may fall, causing serious injury to a child or an adult, and serious damage to the set.



Use only a cart or stand recommended by the manufacturer for the specific model of TV. Any mounting of the product should follow the manufacturer's instructions, and should use a mounting accessory recommended by the manufacturer. An appliance and cart combination should be moved with care. Quick stops, excessive force, and uneven surfaces may cause the appliance and cart combination to overturn.

Ventilation

The slots and openings in the cabinet and in the back or bottom are provided for necessary ventilation. To ensure reliable operation of the set, and to protect it from overheating, these slots and openings must never be blocked or covered.

- **Never cover the slots and openings with a cloth or other materials.**



- **Never block the slots and openings by placing the set on a bed, sofa, rug or other similar surface.**

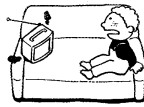

- **Never place the set in a confined space, such as a bookcase or built-in cabinet, unless proper ventilation is provided.**



- **Do not place the set near or over a radiator or heat register, or where it is exposed to direct sunlight.**



Power-Cord Protection

Do not allow anything to rest on or roll over the power cord, and do not place the set where the power cord is subject to wear or abuse.

Antennas

Outdoor Antenna Grounding

If an outdoor antenna is installed, follow the precautions below. An outdoor antenna system should not be located in the vicinity of overhead power lines or other electric light or power circuits, or where it can come in contact with such power lines or circuits.

WHEN INSTALLING AN OUTDOOR ANTENNA SYSTEM, EXTREME CARE SHOULD BE TAKEN TO KEEP FROM CONTACTING SUCH POWER LINES OR CIRCUITS AS CONTACT WITH THEM IS ALMOST INVARIABLY FATAL.

Be sure the antenna system is grounded so as to provide some protection against voltage surges and built-up static charges. Section 810 of the National Electrical Code (NEC) in USA and Section 54 of the Canadian Electrical Code in Canada provides information with respect to proper grounding of the mast and supporting structure, grounding of the lead-in wire to an antenna discharge unit, size of grounding conductors, location of antenna discharge unit, connection to grounding electrodes, and requirements for the grounding electrode.

Antenna Grounding According to the NEC

Antenna Grounding According to the National Electrical Code, ANSI/NFPA 70.

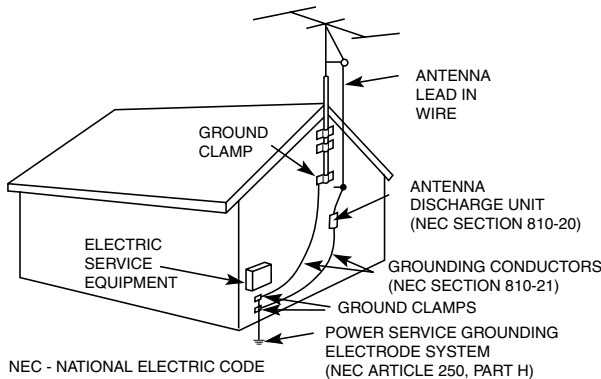

Lightning

For added protection for this television receiver during a lightning storm, or when it is left unattended and unused for long periods of time, unplug it from the wall outlet and disconnect the antenna. This will prevent damage to the receiver due to lightning and power-line surges.

Service

Damage Requiring Service

Unplug the set from the wall outlet and refer servicing to qualified service personnel under the following conditions:

- **When the power cord or plug is damaged or frayed.**

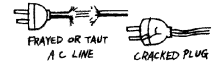

- **If liquid has been spilled into the set or objects have fallen into the product.**

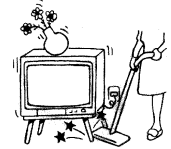

- **If the set has been exposed to rain or water.**



- **If the set has been subject to excessive shock by being dropped, or the cabinet has been damaged.**

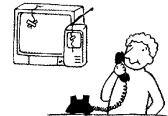

- **If the set does not operate normally when following the operating instructions. Adjust only those controls that are specified in the operating instructions. Improper adjustment of other controls may result in damage and will often require extensive work by a qualified technician to restore the set to normal operation.**



- **When the set exhibits a distinct change in performance — this indicates a need for service.**

Servicing

Do not attempt to service the set yourself since opening the cabinet may expose you to dangerous voltage or other hazards. Refer all servicing to qualified service personnel.



Replacement Parts

When replacement parts are required, be sure the service technician certifies in writing that he has used replacement parts specified by the manufacturer that have the same characteristics as the original parts. Unauthorized substitutions may result in fire, electric shock, or other hazards.



Safety Check

Upon completion of any service or repairs to the set, ask the service technician to perform routine safety checks (as specified by the manufacturer) to determine that the set is in safe operating condition, and to so certify. When the set reaches the end of its useful life, improper disposal could result in a picture tube implosion. Ask a qualified service technician to dispose of the set.



Connecting Your TV

Read this section before setting up your TV for the first time. This section covers basic connections in addition to any optional equipment you may be connecting.

TV Rear Panel

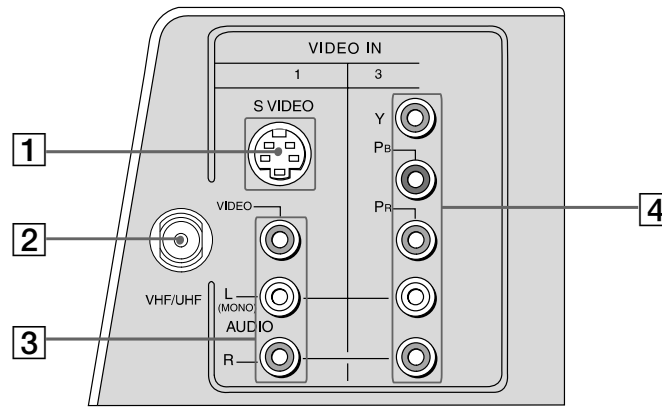

Connections

Jack	Description
1 S VIDEO	Connects to the S VIDEO OUT jack on your VCR or other video equipment that has S VIDEO. S VIDEO provides better picture quality than the VHF/UHF jacks or the video input jack. S VIDEO does not provide sound; the audio cables must still be connected.
2 VHF/UHF	Connects to your VHF/UHF antenna or cable.
3 Video/Audio L(Mono),R	Connects to the AUDIO and VIDEO output jacks on your VCR or other video equipment. A second video input jack (VIDEO 2) is located on the front panel of the TV. These AUDIO/VIDEO input jacks provide better picture quality than the VHF/UHF jack.
4 Y, Pb, Pr/L, R	Connects to the component video Y, Pb, Pr to AUDIO L and R output jacks on your DVD player or Digital Set-top box.

S-VIDEO is only for KV-24FS120.

The rear panels illustrated in this manual are for KV-24FS120. The real panels on your TV may not look exactly like those illustrated.

Basic Connections

TV with indoor or outdoor antenna, or CATV cable

Depending on the cable available in your home, choose one of the connections below:

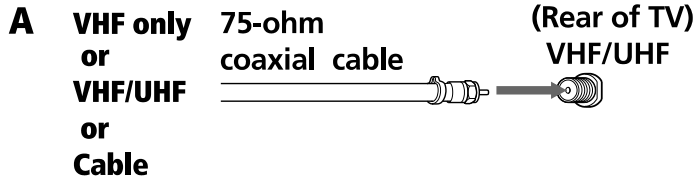

Use this to connect the TV to a cable system or an antenna with a 75-ohms cable (usually built into newer homes).

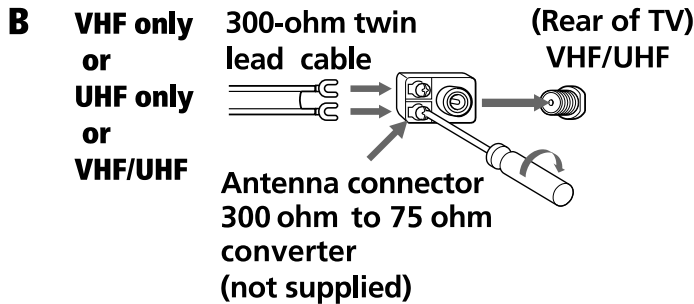

Use this to connect the TV to a dipole antenna, also known as “rabbit ears” antenna (usually found in to older homes).

 If you are connecting to an indoor or outdoor antenna, you may need to adjust the orientation of the antenna for best reception.

Connecting Additional Equipment

TV and VCR

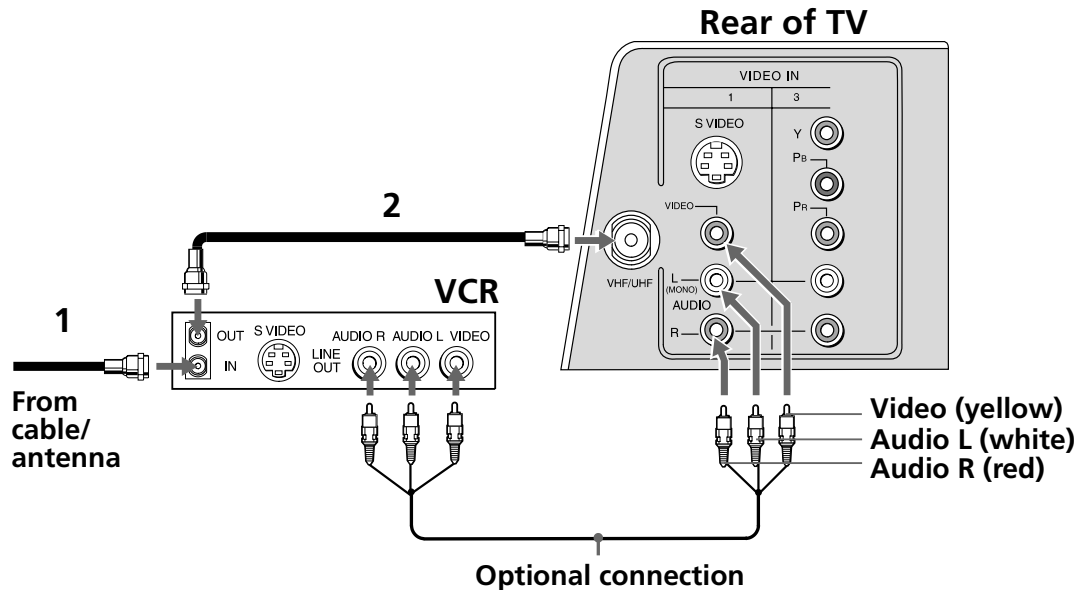

To watch video programs from your VCR, tune your TV to channel 3 or 4 (as set on the rear of your VCR).

- 1** Connect the coaxial cable from your TV antenna or cable service to the IN jack on your VCR.
- 2** Connect a coaxial cable (not supplied) from the OUT jack on your VCR to the VHF/UHF jack on the TV.

Optional connection

- If your VCR is equipped with video outputs, you can get better picture quality by connecting Audio/Video cables (not supplied) from AUDIO and VIDEO OUT on your VCR to AUDIO/VIDEO IN on your TV.
- For better picture quality, use S VIDEO instead of the yellow Audio/Video cable. S-VIDEO does not provide sound; the audio cables must still be connected.

S-VIDEO is only for KV-24FS120 model.

You can use the button to switch between the VHF/UHF and VIDEO inputs.

TV and Cable Box

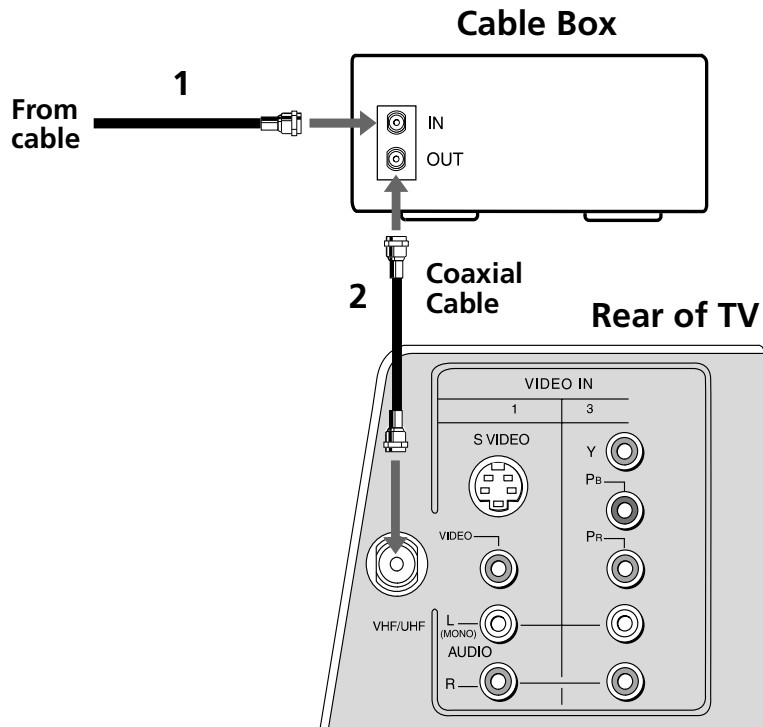

- 1** Connect the coaxial cable from your cable service to the IN jack on your cable box.
- 2** Connect a coaxial cable (not supplied) from the OUT jack on your cable box to the VHF/UHF jack on the TV.

Optional Connection

- ❑ To view channels from your cable box, tune your TV to channel 3 or 4 (as set on the rear panel of your cable box) and use the cable box's remote control to change channels.
- ❑ If you will be controlling all channel selection through your cable box, you should consider using the Channel Fix feature by setting your TV to channel 3 or 4 (see page 22).

TV, VCR, and Cable Box

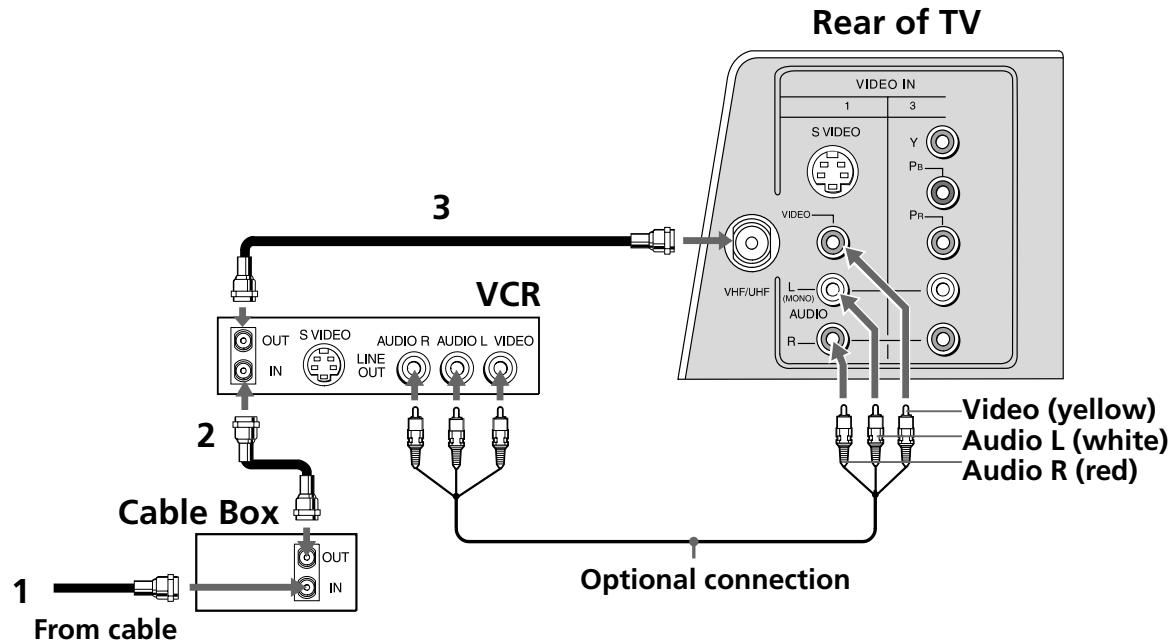

- 1** Connect the coaxial cable from your cable service to the IN jack on your cable box.
- 2** Connect a coaxial cable (not supplied) from the OUT jack on your cable box to the IN jack on your VCR.
- 3** Connect a coaxial cable (not supplied) from the OUT jack on your VCR to the VHF/UHF jack on the TV.

If you will be controlling all channel selection through your cable box, you should consider using the Channel Fix feature by setting your TV to channel 3 or 4 (see page 22).

Optional connection

- If your VCR is equipped with video outputs, you can get better picture quality by connecting Audio/Video cables (not supplied) from Audio and Video OUT on your VCR to Audio/Video IN on your TV.
- For better picture quality, use S VIDEO instead of the yellow Audio/ Video cable. S-VIDEO does not provide sound; the audio cables must still be connected.

S-VIDEO is only for KV-24FS120 model.

You can use the button to switch between the VHF/UHF and VIDEO inputs.

TV and Satellite Receiver

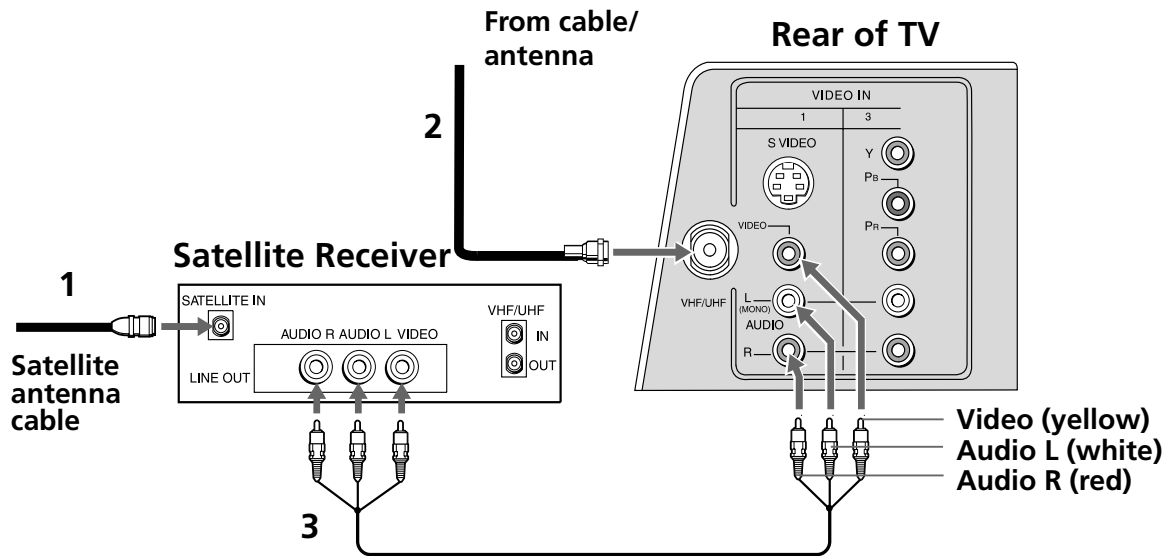

- 1** Connect the cable from your satellite antenna to SATELLITE IN on your satellite receiver.
- 2** Connect the coaxial cable from your cable service or antenna to the VHF/UHF jack on your TV.
- 3** Using audio/video cables (not supplied), connect AUDIO and VIDEO OUT on your satellite receiver to AUDIO and VIDEO IN on your TV.

To watch video programs from your Satellite receiver, tune your TV to channel 3 or 4.

Optional Connection

- For better picture quality, use S VIDEO instead of the yellow audio/video cable. S-VIDEO does not provide sound; the audio cables must still be connected.

S-VIDEO is only for KV-24FS120 model.

You can use the button to switch between the VHF/UHF and VIDEO inputs.

TV, Satellite Receiver, and VCR

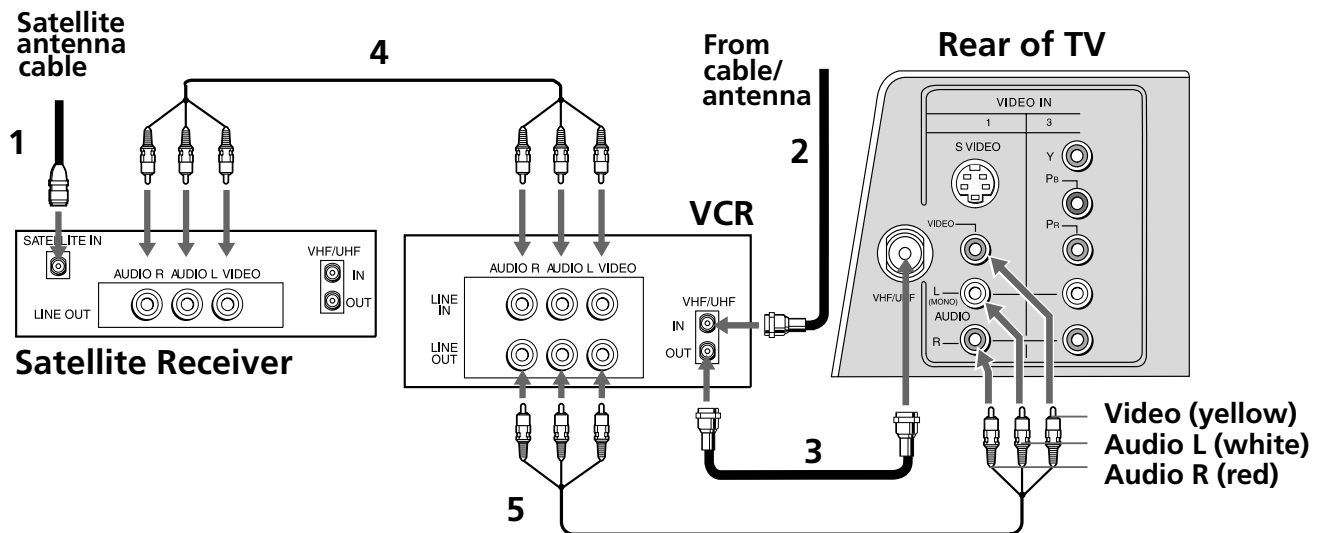

Connections

- 1** Connect the cable from your satellite antenna to SATELLITE IN on the satellite receiver.
- 2** Connect the coaxial cable from your cable service or antenna to the IN jack on your VCR.
- 3** Using a coaxial cable (not supplied), connect the OUT jack on your VCR to the VHF/UHF jack on your TV.
- 4** Using audio/video cables (not supplied), connect AUDIO and VIDEO OUT on your satellite receiver to AUDIO and VIDEO IN on your VCR.
- 5** Using audio/video cables (not supplied), connect AUDIO and VIDEO OUT on your VCR to AUDIO and VIDEO IN on your TV.

Optional Connection

- ❑ To view from the satellite receiver or VCR, select the video input to which your satellite receiver or VCR is connected by pressing TV/VIDEO on the remote control.

Connecting a DVD Player using Composite Video (Video/Audio L(Mono), R)

Using audio/video cables (not supplied), connect AUDIO/VIDEO OUT on your DVD player to AUDIO/VIDEO IN on your TV.

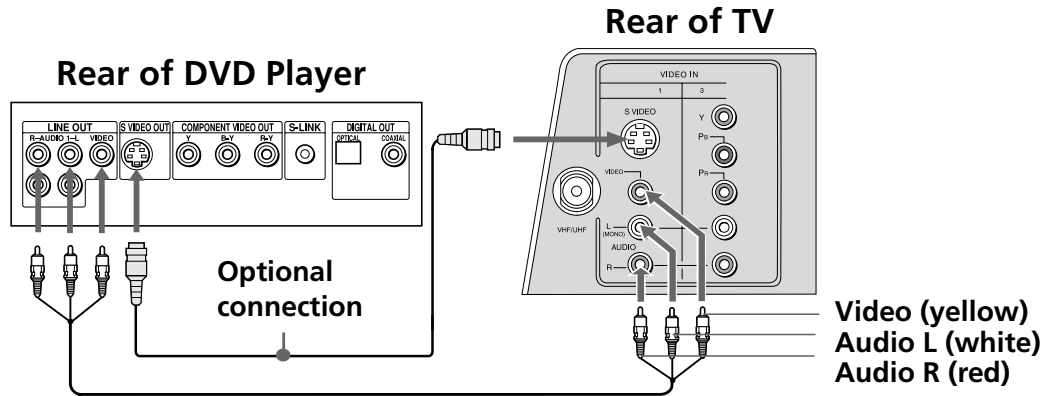

Optional connection

- ❑ For better picture quality, use S VIDEO instead of the yellow audio/video cable. S-VIDEO does not provide sound, so you still must connect the audio cables.

Connecting a DVD Player using Component Video (Y, P_B, P_R)

- ❑ If your DVD player is equipped with component video outputs (Y, P_B, P_R/L, R), you can improve the picture quality by using component video cables (480i only).

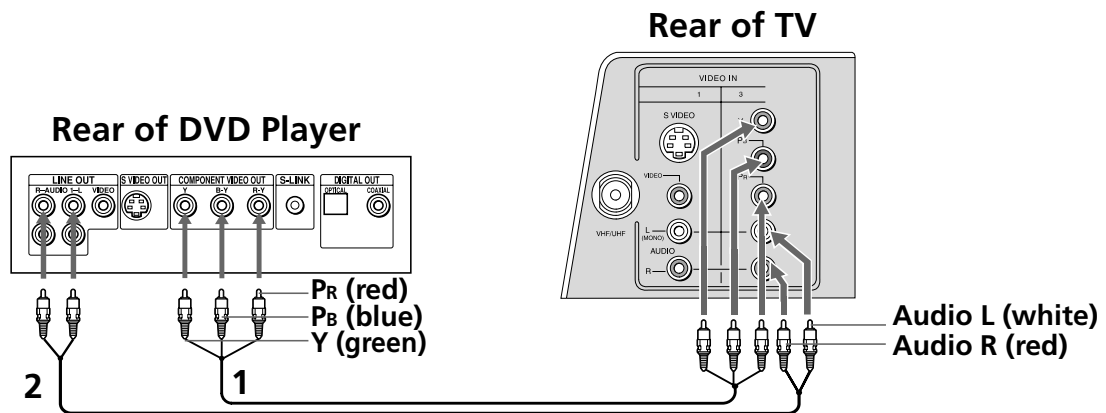

- 1 Using component video cables (not supplied), connect the Y, P_B, P_R OUT on your DVD player to Y, P_B, P_R IN on your TV.
- 2 Connect AUDIO OUT on your DVD player to AUDIO IN on your TV.

The Y, P_B, P_R outputs on your DVD player are sometimes labeled Y, C_B, and C_R or Y, B-Y, and R-Y. If so, connect the cables to like colors.

Connecting Headphones

Connect the headphones to the  jack on the front of your TV. Headphone jack is STEREO.

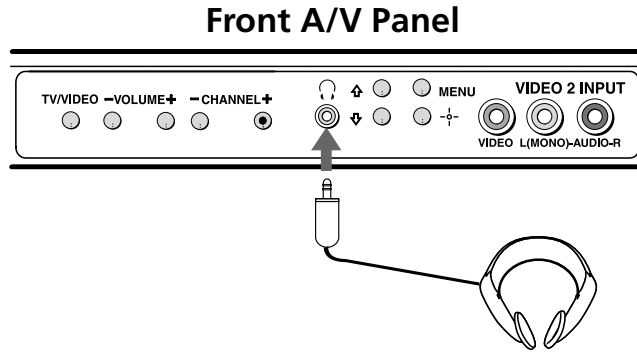

Connecting a Camcorder

Using audio/video cables (not supplied), connect AUDIO and VIDEO OUT on your camcorder to AUDIO and VIDEO IN on your TV.

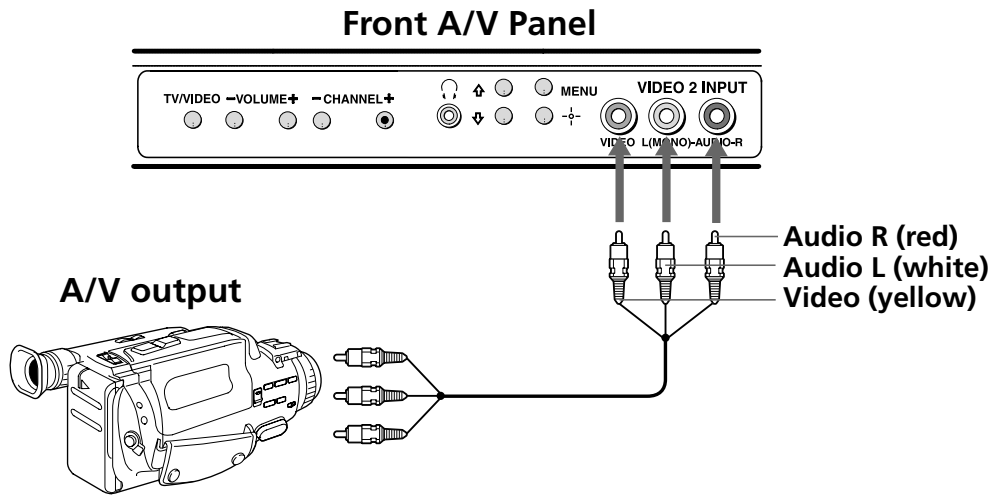

Connecting for Video Tape Editing (VCR and Camcorder)

Camcorder (for playback)



A/V output

VCR (for playback)

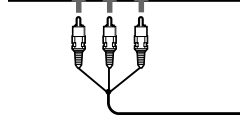
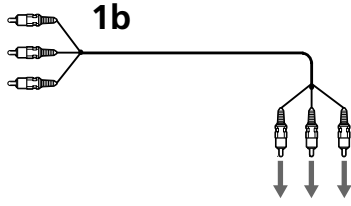
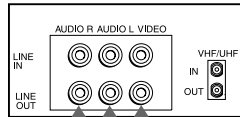

1a

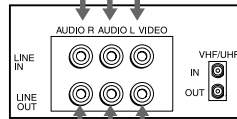

VCR (for recording)

2

Rear of TV

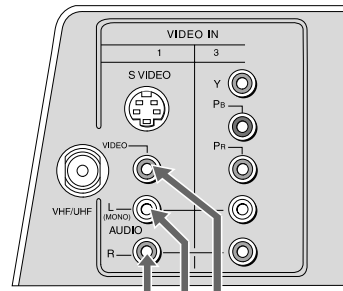

Video (yellow)
Audio L (white)
Audio R (red)

- 1 For video tape editing connect to the VCR the following sources (VCR or Camcorder):
 - a) Using audio/video cables (not supplied), connect AUDIO/VIDEO OUT on your first VCR to AUDIO/VIDEO IN on your second VCR
 - b) Using audio/video cables (not supplied), connect the AUDIO/VIDEO OUT on your Camcorder to the AUDIO/VIDEO IN on your second VCR
- 2 Using audio/video cables (not supplied), connect AUDIO/VIDEO OUT on the second VCR to the AUDIO/VIDEO IN on your TV.

Other Information

Troubleshooting

If you have a problem with your TV, try the suggestions below. If the problem persists, see "Contacting Sony" at the end of this section.

General

Problem	Possible Remedies
I want to reset the TV to the factory settings	<ul style="list-style-type: none"> <input type="checkbox"/> Turn on the TV. While holding down the RESET button on the remote control, press POWER button on the TV front panel. The TV will turn itself off, then back on again. Release the RESET button.
The TV is dirty	<ul style="list-style-type: none"> <input type="checkbox"/> Clean the TV with a soft dry cloth. Never use strong solvents such as thinner or benzine, which might damage the finish of the cabinet.
I lost the parental control password	<ul style="list-style-type: none"> <input type="checkbox"/> In the password screen, enter the following master password: 4357. After using the master password, you must create a new password. You cannot use the master to unlock currently blocked channels.
There is a black box on the screen	<ul style="list-style-type: none"> <input type="checkbox"/> You have selected a text option in the Setup menu (page 31) and no text is available. To turn off this feature, select Off in the Caption Vision option. If you were trying to select closed captioning, select CC1-4 instead of Text1-4.
There was a blackout or power outage, and now the TV won't turn on and the timer LED is flashing	<ul style="list-style-type: none"> <input type="checkbox"/> Press the POWER button on your remote control or on the TV front panel.
Digital cable box does not work	<ul style="list-style-type: none"> <input type="checkbox"/> Be sure that you have not connected the digital cable box to the TV's jack. This jack is not compatible with digital cable boxes. <input type="checkbox"/> If you are connecting a VCR and digital cable box using a splitter, as described in pages 9, you must use a special bi-directional splitter that is designed to work with your digital cable box.

Remote Control

Problem	Possible Remedies
I cannot operate the remote control	<ul style="list-style-type: none"> <input type="checkbox"/> Check the orientation of the batteries. <input type="checkbox"/> Batteries could be weak. Replace them (page 2). <input type="checkbox"/> Move the TV three to four feet away from fluorescent lights.
I cannot change channels with the remote control	<ul style="list-style-type: none"> <input type="checkbox"/> Make sure you have not inadvertently switched your TV from the channel 3 or 4 setting if you are using another device to change channels.
I lost the remote control	<ul style="list-style-type: none"> <input type="checkbox"/> You can use the front panel controls to access your menus, change channels, adjust the volume, or change video inputs (page 2). Contact your nearest Sony Dealer to order a replacement, please call our Sony Direct Accessory and Part Center at 1-800-488-7669 (U.S. residents only).

Video

Problem	Possible Remedies
No picture, no sound	<ul style="list-style-type: none"> <input type="checkbox"/> Make sure the power cord is plugged in. <input type="checkbox"/> If a red light is flashing on the front of your TV for more than a few minutes, disconnect and reconnect the power cord. If the problem continues, call your local service center. <input type="checkbox"/> Check the TV/VIDEO setting: when watching TV, set it to TV; when watching video equipment, set it to VIDEO 1, 2 or 3 (page 3). <input type="checkbox"/> Try another channel to rule out station trouble.
Poor or no picture, good sound	<ul style="list-style-type: none"> <input type="checkbox"/> Adjust the Picture setting in the Video menu (page 20). <input type="checkbox"/> Adjust the Brightness setting in the Video menu (page 20). <input type="checkbox"/> Check the antenna and/or cable connections (page 6).
No color	<ul style="list-style-type: none"> <input type="checkbox"/> Adjust the Color setting in the Video menu (page 20).
Only snow appears on the screen	<ul style="list-style-type: none"> <input type="checkbox"/> Check the Cable setting in the Channel menu (page 22). <input type="checkbox"/> Check the antenna and/or cable connections (page 6). <input type="checkbox"/> Make sure the channel selected is currently broadcasting.
Dotted lines or stripes	<ul style="list-style-type: none"> <input type="checkbox"/> Adjust the antenna. <input type="checkbox"/> Move the TV away from other electronic equipment. Some electronic equipment creates electrical noise, which can interfere with TV reception.
Double images or ghosts	<ul style="list-style-type: none"> <input type="checkbox"/> Check your outdoor antenna or call your cable service.

Audio

Problem	Possible Remedies
Good picture, no sound	<ul style="list-style-type: none"> <input type="checkbox"/> Press  so that Muting disappears from the screen (page 3). <input type="checkbox"/> Check your Audio settings. Your TV may be set to Auto SAP in the MTS feature (page 21). <input type="checkbox"/> Adjust your TV's volume.
Low or no audio (TV and Cable box)	<ul style="list-style-type: none"> <input type="checkbox"/> Some cables boxes have volume level controls. Check and see if your cable box or cable box remote has a volume control.

Channels

Problem	Possible Remedies
I cannot receive higher number channels (UHF) when using an antenna	<ul style="list-style-type: none"> <input type="checkbox"/> Make sure Cable is set to Off in the Channel menu (page 22). <input type="checkbox"/> Perform Auto Program to add channels that are not presently in the memory (page 15).
Cable stations don't seem to work	<ul style="list-style-type: none"> <input type="checkbox"/> Make sure Cable is set to On in the Channel menu (page 22). <input type="checkbox"/> Perform Auto Program to add channels that are not presently in the memory (page 15).

Contacting Sony

Before calling our Customer Information Services Center, reset the TV to factory settings (see page 23). Please have your TV serial number ready. The number is located on the rear of your TV and on the front cover of this manual.

Our Customer Information Services Center phone number is 1-800-222-SONY (7669) (US residents only) or 1-877-899-SONY (7669) (Canadian residents only).

FD Trinitron
WEGA[®]

Manual de Instrucciones

KV-21FM120
KV-21FS120
KV-25FS120

Lea este manual antes de operar el producto.

ADVERTENCIA

Para evitar el riesgo de incendio o descarga eléctrica, no exponga el televisor a la lluvia o humedad.



Este símbolo señala al usuario la presencia de voltaje peligroso sin aislamiento en el interior del aparato de tal intensidad que podría presentar riesgo de descarga eléctrica.



Este símbolo indica al usuario que el manual que acompaña a este aparato contiene instrucciones importantes referentes a su funcionamiento y mantenimiento.

Nota para el instalador de CATV

Esta nota pretende llamar la atención del instalador del sistema CATV en relación con el artículo 820-40 de la NEC que proporciona las pautas para una adecuada conexión a tierra y, en particular, especifica que el cable de conexión a tierra debe estar conectado al sistema de toma de tierra del edificio lo más cerca posible de la entrada del cable.

PRECAUCIONES DE SEGURIDAD

- Utilice el televisor con ca (corriente alterna) como se menciona a continuación para todos los países excepto en donde se indique:
ca 120 V 60 Hz
ca 220 V 50/60 Hz (Chile, Perú, Bolivia)
- Una terminal del enchufe es más ancha que la otra para garantizar la seguridad y solo se podrá introducir en la toma de corriente de una manera (sólo los modelos con ca 120 V). Si no puede insertar completamente el enchufe en la toma, póngase en contacto con su proveedor.
- Si se introduce algún objeto sólido o líquido en el televisor, desconéctelo y haga que sea revisado por personal especializado antes de volver a utilizarlo.

PRECAUCION

PARA EVITAR DESCARGAS ELÉCTRICAS, INTRODUZCA EL ENCHUFE EN EL TOMACORRIENTE POR COMPLETO, CON EL CONTACTO ANCHO DEL ENCHUFE EN LA RANURA ANCHA DEL TOMACORRIENTE.

Al usar videojuegos, computadoras y productos similares con el televisor, mantenga los ajustes de brillo y contraste a un nivel moderado. Si una imagen inmóvil permanece en la pantalla durante un periodo prolongado con elevada intensidad de brillo o contraste, la imagen podría quedar grabada en la pantalla en forma permanente. Igualmente, ver continuamente el mismo canal de televisión podría dejar grabada en la pantalla el logotipo de la emisora. La garantía no cubre este tipo de anomalías, ya que se deben al mal uso del aparato.



Para reducir el riesgo de descarga eléctrica, no utilice el enchufe polarizado con un cable de extensión, un receptáculo ni otras tomas, a menos que las terminales estén bien insertadas y no queden expuestas.



Se advierte que cualquier cambio o modificación que no se apruebe de modo explícito en este manual podría anular su autorización para utilizar este equipo.

NOTIFICACION

Este aparato ha sido debidamente probado, comprobándose que cumple con los límites impuestos a dispositivos digitales Clase B de acuerdo con la Sección 15 de las normas de la FCC. Estos límites se establecieron para ofrecer protección razonable contra interferencias perjudiciales en las instalaciones residenciales. Este aparato genera, usa y puede emitir energía radioeléctrica. De no instalarse y utilizarse de acuerdo con las instrucciones correspondientes, podría producir interferencias perjudiciales en las radiocomunicaciones. No obstante, no puede garantizarse que no se produzcan estas interferencias en una instalación determinada. Si este aparato llega a interferir en la recepción de radio o televisión, lo que podrá comprobarse encendiendo y apagando el aparato, se recomienda al usuario intentar corregir la interferencia mediante una o más de las siguientes medidas:

- Reoriente o cambie de lugar las antenas receptoras.
- Aumente la distancia que separa este aparato del receptor afectado.
- Conecte el aparato en una toma de corriente de un circuito distinto al que esté conectado el receptor que está afectado.
- Consulte con el distribuidor o solicite los servicios de un técnico capacitado en radio y televisión. Cualquier cambio o modificación que no se detalla expresamente en el presente manual podría invalidar su autorización para emplear este aparato.

Protección del televisor

- Para evitar el sobrecalentamiento interno, no obstruya los orificios de ventilación.
- No instale el televisor en un lugar con temperatura elevada, humedad, exceso de polvo o donde puedan producirse vibraciones.

Nota sobre Caption Vision

Este receptor de televisión proporciona pantalla de televisión con visualización de subtítulos de acuerdo con el punto § 15.119 del reglamento de la FCC.

El uso del televisor con finalidades distintas a la visualización privada de emisiones de programas en UHF o VHF o transmisiones vía cable dirigidas al público en general puede requerir la autorización de la compañía de emisión por cable y/o del propietario del programa.

Información para el propietario

Los números de serie y modelo están situados en la portada de este manual y en la parte posterior del televisor.

Marcas comerciales y derechos de autor

ENERGY STAR® es una marca registrada.

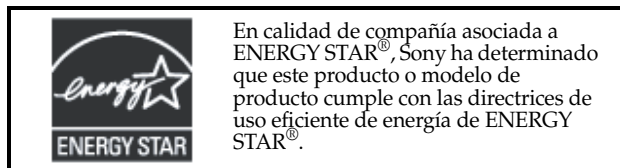

WEGA, FD Trinitron, Caption Vision, Steady Sound, Intelligent Picture son marcas comerciales de Corporación Sony.

Normas importantes sobre seguridad

Para su protección, lea detenidamente estas instrucciones y guarde este manual para futuras consultas.

Lea cuidadosamente todas las advertencias y precauciones y siga las instrucciones inscritas en el televisor o descritas en el manual de instrucciones o de reparación.

ADVERTENCIA

Para protegerse contra daños personales, siga las precauciones de seguridad básicas durante la instalación, la utilización y el mantenimiento del televisor indicadas a continuación.

USO

Fuentes de alimentación

Este televisor solamente deberá alimentarse con el tipo de fuente de alimentación indicado en la etiqueta de serie/modelo. Si no está seguro sobre el tipo de red eléctrica de su hogar, consulte a su proveedor o a la compañía de suministro eléctrico local. En caso de un televisor diseñado para alimentarse con baterías, consulte su manual de instrucciones.

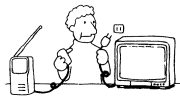

Conexión a tierra o polarización

Este aparato cuenta con cable eléctrico con clavija polarizada (con una terminal más ancha que la otra), o con tres terminales (la tercera es para la conexión). Siga las instrucciones indicadas a continuación:

Para los equipos con un enchufe de cable de alimentación de ca polarizado

El enchufe se introduce en la toma de corriente en una única dirección. Se trata de una característica de seguridad. Si no puede insertar completamente el enchufe en la toma, intente girar el enchufe. Si sigue teniendo problemas para insertar el enchufe, póngase en contacto con su electricista para que le instale una toma adecuada. No ponga a prueba la finalidad de seguridad del enchufe polarizado forzándolo.



Advertencia alternativa

Para los equipos con un enchufe de ca con tres cables de conexión de tierra

Este enchufe únicamente se acoplará a una toma de corriente de conexión a tierra. Se trata de una característica de seguridad. Si no puede insertar el enchufe en la toma, póngase en contacto con su electricista para que le instale una toma adecuada. No ponga a prueba la seguridad del enchufe de conexión a tierra.

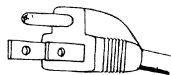

Sobrecarga

No sobrecargue las tomas de pared, los cables de extensión ni los receptáculos más allá de su capacidad, puesto que podría producirse un incendio o una descarga eléctrica. Apague siempre el aparato cuando no lo utilice. Si no va a utilizar el aparato durante un tiempo prolongado, desconéctelo de la toma de pared como precaución ante la posibilidad de que se produzca un mal funcionamiento interno que pueda provocar un incendio.

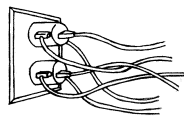

No desconecte la antena ni el cable de alimentación en caso de tormenta. Los relámpagos podrían descargar mientras sujeta el cable y provocarle lesiones graves. Apague el televisor y espere que el tiempo mejore.



Introducción de objetos y líquidos

No introduzca objetos de ningún tipo a través de las ranuras del gabinete, ya que podrían tocar puntos de tensión peligrosa o provocar cortocircuitos de piezas, lo que podría resultar en incendios o descargas eléctricas. No derrame nunca ningún tipo de líquido sobre el televisor.



Accesorios

No utilice ningún accesorio no recomendado por el fabricante, ya que podría ser peligroso. No coloque ningún tipo de objetos, especialmente objetos pesados, encima del aparato. Podrían caerse del aparato y causar lesiones.



Limpieza

Antes de limpiar el televisor, desconéctelo de la alimentación. No utilice limpiadores líquidos ni aerosoles. Para limpiar el exterior del televisor, emplee un paño ligeramente humedecido en agua.



Si se produce un ruido continuo o intermitente en el interior del aparato de televisión mientras está en funcionamiento, desconecte el televisor y póngase en contacto con el proveedor o con el servicio de asistencia técnica. Es normal que algunos aparatos de televisión produzcan ocasionalmente este tipo de ruidos, especialmente cuando se conectan y desconectan.

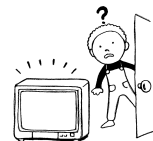

Instalación

Para levantar o mover el aparato siempre se deberá hacer entre dos o más personas. El aparato es pesado y la superficie inferior es plana. Si intenta mover el aparato sin ayuda o lo manipula de forma insegura, puede producirse lesiones graves. Instale el aparato sobre una superficie plana y estable.

Agua y humedad

No utilice aparatos de alimentación eléctrica cerca del agua — por ejemplo, cerca de una bañera, un lavabo, un fregadero o una lavadora, en un sótano húmedo, ni cerca de una piscina, etc.

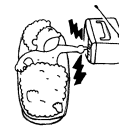

Colocación

No coloque el televisor sobre una mesita con ruedas, un pedestal, una mesa o un estante inestable. El televisor podría caer, causando daños serios a niños, adultos y al propio televisor. Utilice solamente la mesita de ruedas o soporte recomendado por el fabricante para el modelo específico. La combinación de un televisor y un mueble con ruedas deberá moverse con cuidado. Las paradas bruscas, la fuerza excesiva y las superficies desiguales pueden hacer que el aparato y el mueble volteen.

Desconecte todos los cables del aparato antes de intentar moverlo.

No permita que niños o animales se suban encima del aparato o lo empujen. El aparato podría caerse y causar lesiones graves.



Ventilación

Las ranuras y aberturas en la parte posterior o inferior del televisor son para permitir la ventilación necesaria. Para asegurar la operación fiable del televisor y protegerlo contra el sobrecalentamiento, estas ranuras y aberturas no deberán cubrirse ni bloquearse nunca.

❑ No tape las ranuras ni aberturas con paños ni otros materiales.

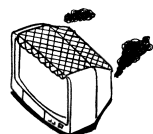

❑ No bloquee las ranuras ni aberturas colocando el televisor sobre una cama, sofá, alfombra u otras superficies similares.

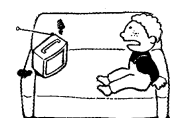

- ❑ No coloque el televisor en un lugar cerrado, como en un librero o un mueble empotrado, a menos que esté adecuadamente ventilado.



- ❑ No coloque el televisor cerca, ni sobre un radiador o una salida de aire caliente, ni expuesto a la luz solar directa.



Protección del cable de alimentación

No permita que ningún objeto quede sobre el cable de alimentación, ni coloque el televisor donde el cable pueda quedar sometido a desgaste o presión.



Conexión a tierra o polarización

Este aparato puede estar equipado con un enchufe de línea de corriente alterna polarizado (con una terminal más ancha que la otra). El enchufe sólo se puede introducir en la toma de corriente en una dirección. Se trata de una característica de seguridad. Si no puede insertar completamente el enchufe en la toma, intente girarlo. Si sigue teniendo problemas para introducir el enchufe, póngase en contacto con su electricista para que sustituya la toma obsoleta. No ponga a prueba la seguridad del enchufe polarizado.

Antenas

Conexión a tierra de una antena exterior

Para instalar una antena exterior, siga los procedimientos que se indican a continuación. Los sistemas de antenas exteriores no deben situarse cerca de líneas eléctricas o circuitos de alimentación o luz eléctrica, o bien donde pueda entrar en contacto con dichas líneas eléctricas o circuitos.

CUANDO INSTALE UN SISTEMA DE ANTENA EXTERIOR, EXTREME LAS PRECAUCIONES Y MANTÉNGALO ALEJADO DE DICHAS LINEAS ELECTRICAS O CIRCUITOS, DADO QUE EL CONTACTO PUEDE RESULTAR FATAL.

Asegúrese de que el sistema de antena tiene conexión a tierra para proporcionar protección contra los incrementos de voltaje y el aumento de las cargas estáticas. El apartado 810 del Código Eléctrico Nacional (NEC) en EE.UU. y el apartado 54 del Código eléctrico de Canadá proporcionan información relativa a la conexión a tierra adecuada del mástil y de la estructura de soporte, la conexión a tierra del cable de conexión a la unidad de descarga de la antena, el tamaño de los conductores de la conexión a tierra, la ubicación de la unidad de descarga de la antena, la conexión de los electrodos de conexión a tierra y los requisitos de los electrodos de conexión a tierra.

Conexión a tierra de la antena de acuerdo con el Código Eléctrico Nacional, ANSI/NFPA 70

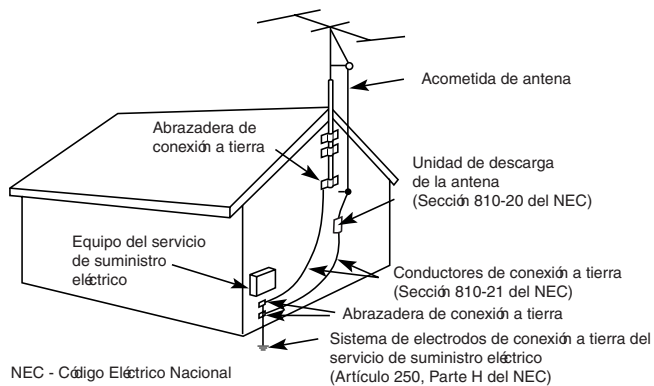

NEC - Código Eléctrico Nacional

Rayos

Para mayor protección del receptor de televisión durante una tormenta con rayos o cuando no se utiliza durante largos periodos de tiempo, desconéctelo de la toma de pared y desconecte la antena. Con ello evitará que los rayos y los incrementos de voltaje dañen el receptor.

Reparación

Daños que requieren reparación

Desconecte el aparato de la toma de pared y haga que sea revisado por personal calificado cuando se produzcan las siguientes condiciones:

- ❑ Si el cable de alimentación o el enchufe están dañados o deshilachados.

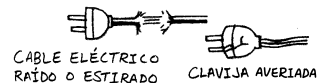

- ❑ Si se ha vertido líquido en el interior del aparato o si se han caído objetos en el interior del producto.

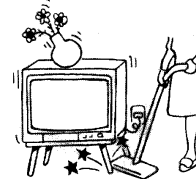

- ❑ Si el aparato se ha expuesto a lluvia o agua.



- ❑ Si el aparato se ha caído y ha sufrido golpes excesivos o si se ha dañado la unidad.

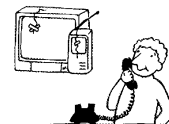

- ❑ Si el aparato no funciona con normalidad al seguir las instrucciones del manual. Ajuste solamente los controles que se especifican en el manual de instrucciones. El ajuste inadecuado de otros controles puede provocar daños y a menudo requerirá mucho trabajo por parte de un técnico calificado para restablecer el funcionamiento normal del aparato.

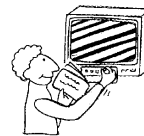

- ❑ Si el aparato muestra un cambio de rendimiento significativo, debe repararse.

Asistencia técnica

No intente reparar por sí mismo el aparato ya que al abrir el gabinete se vería expuesto a tensiones peligrosas y otros riesgos. Solicite los servicios de personal de reparación calificado.



Piezas de reemplazo

Si necesita piezas de reemplazo, asegúrese de que el técnico certifique por escrito que ha utilizado piezas de reemplazo especificadas por el fabricante con las mismas características que las piezas originales. El uso de piezas no autorizadas puede provocar incendios, descargas eléctricas y otros peligros.



Comprobación de seguridad

Después de realizar cualquier reparación del aparato, solicite al técnico de la reparación que realice comprobaciones rutinarias de seguridad (como especifica el fabricante) para determinar si el aparato se encuentra en condiciones seguras de funcionamiento y certificarlo. Cuando el aparato llega al final de su vida útil, debe desecharse adecuadamente para evitar una implosión del tubo de la imagen. Consulte a un técnico de reparación calificado para depositar el aparato.



Conexión del televisor

Lea este capítulo antes de instalar el televisor por primera vez. Este capítulo hace referencia a las conexiones básicas, así como a cualquier otro equipo opcional que conecte.

Panel posterior del televisor

 Los paneles frontales y posteriores del televisor que se ilustran en este manual corresponden al modelo KV-25FS120.

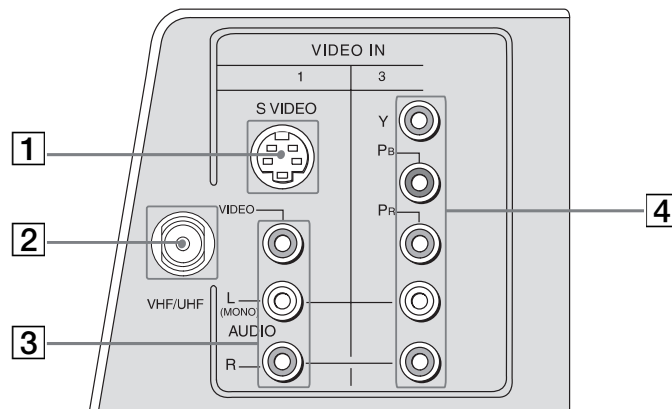

Toma	Descripción
1 S VIDEO	Establece una conexión con la toma S VIDEO OUT (salida de S video) de la videgrabadora o de otro equipo de video con S VIDEO. S VIDEO proporciona una mejor calidad de imagen que las tomas VHF/UHF o la toma de entrada de video. S VIDEO no proporciona sonido; los cables de audio deben estar conectados.
2 VHF/UHF	Establece una conexión con el cable o la antena de VHF/UHF.
3 VIDEO/AUDIO L(MONO)/R	Establece una conexión con las tomas de salida de AUDIO y VIDEO de la videgrabadora o de otro equipo de video. En el panel frontal del televisor existe una segunda toma de entrada de video (VIDEO 2). Estas tomas de entrada de AUDIO/VIDEO proporcionan una mejor calidad de imagen que la toma VHF/UHF.
4 Y, Pb, Pr/ L, R	Se conectan con las salidas de video (Y, Pb, Pr) y de audio (L/R) de su reproductor de DVD o de su caja digital.

 S VIDEO proporciona una mejor calidad de imagen que las tomas VHF/UHF o la toma de entrada de video, S-VIDEO es solo para el modelo KV-25FS120.

Conexiones básicas

Televisor con antena interior o exterior o cable CATV

Dependiendo del cable de que disponga, elija una de las siguientes conexiones:

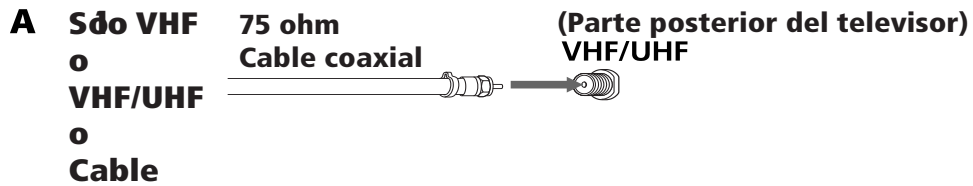

El televisor puede estar conectado ya sea al decodificador o a la antena con un cable de 75-ohm (usualmente ya instalado en casas nuevas).

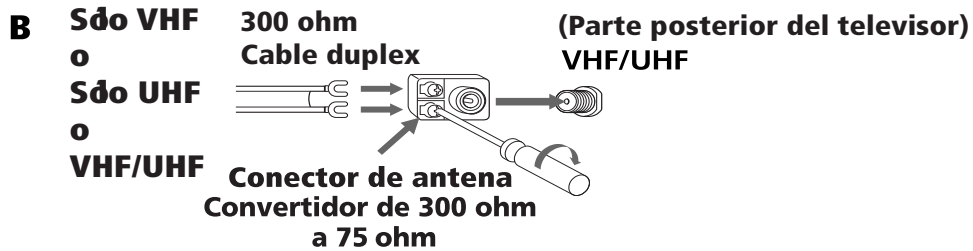

Este puede ser utilizado para conectar el televisor a una antena dipolo, también conocida como antena de conejo (usualmente encontrada en casas viejas).

 Si conecta el televisor a una antena interior o exterior, es posible que deba ajustar la orientación de la antena para obtener una mejor recepción.

Conexión de equipo adicional

Televisor y videgrabadora

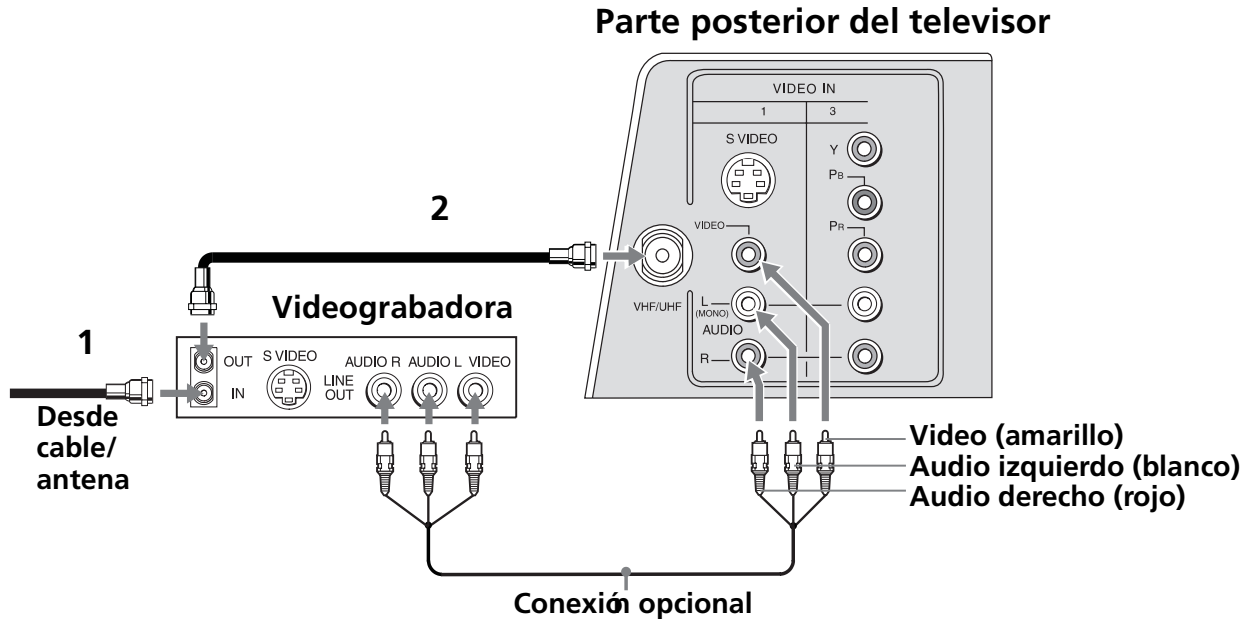

🔧 Para ver programas de video desde la videogradora, sintonice el televisor en los canales 3 ó 4 (como se indica en la parte posterior de la videogradora).

- 1 Conecte el cable coaxial de la antena del televisor o del servicio de cable a la toma IN de la videogradora.
- 2 Conecte el cable coaxial (no incluido) de la toma OUT de la videogradora a la toma VHF/UHF del televisor.

🔧 Puede utilizar el botón  para cambiar entre las entradas VHF/UHF y VIDEO.

Conexión opcional

- ❑ Si la videogradora dispone de salidas de video, puede obtener una mejor calidad de imagen conectando los cables de audio/video (no incluidos) desde la salida AUDIO/VIDEO OUT de la videogradora a la toma AUDIO/VIDEO IN del televisor.
- ❑ Para obtener una mejor calidad de imagen, utilice S VIDEO en lugar del cable amarillo de video. Como S VIDEO no proporciona sonido, debe mantener conectados los cables de audio (solo 25FS120).

🔧 Receptor de satélite y el servicio de cable son sistemas de televisión de pago.

Televisor y caja de cable

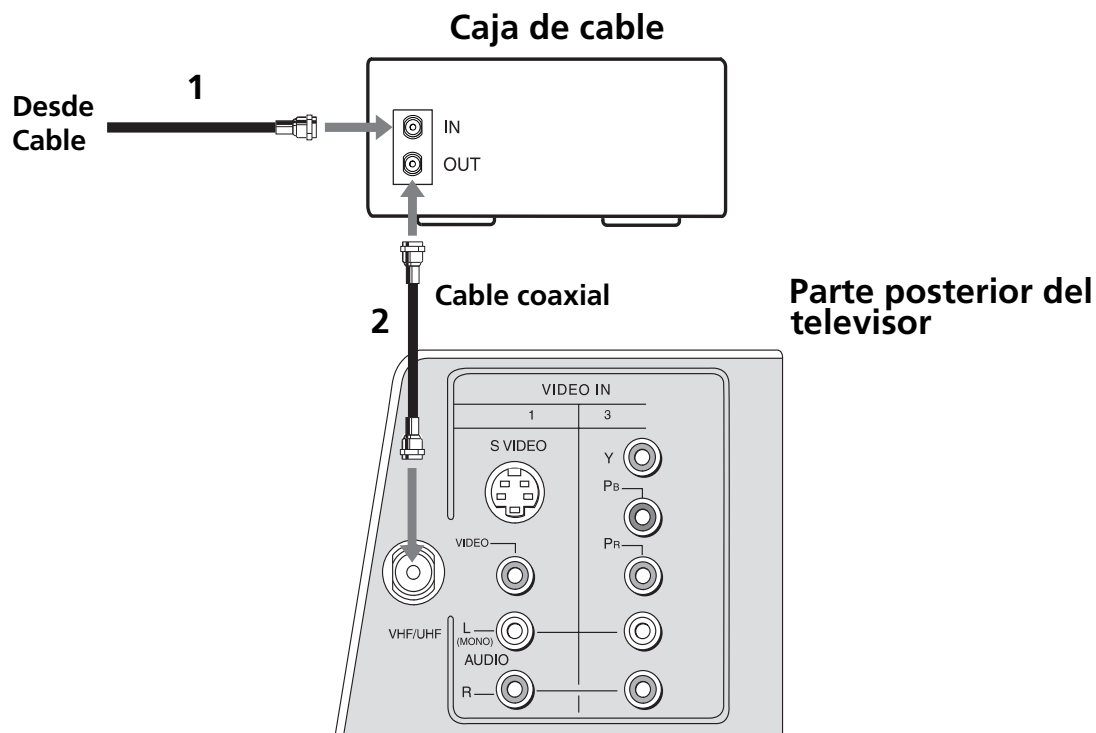

- 1** Conecte el cable coaxial del servicio de cable a la toma IN de la caja de cable.
- 2** Conecte un cable coaxial (no incluido) de la toma OUT de la caja de cable a la toma VHF/UHF del televisor.

Conexión opcional

- Para ver los canales desde la caja de cable, sintonice el televisor en los canales 3 ó 4 (como se indica en el panel posterior de la caja de cable) y utilice el control remoto de la caja de cable para cambiar los canales.
- Si desea controlar la selección de todos los canales a través de la caja de cable, es aconsejable utilizar la función Fijar Canal ajustando el televisor en el canal 3 ó 4 (consulte la página 23).

 Receptor de satélite y el servicio de cable son sistemas de televisión de pago.

Televisor, videograbadora y caja de cable

Parte posterior del televisor

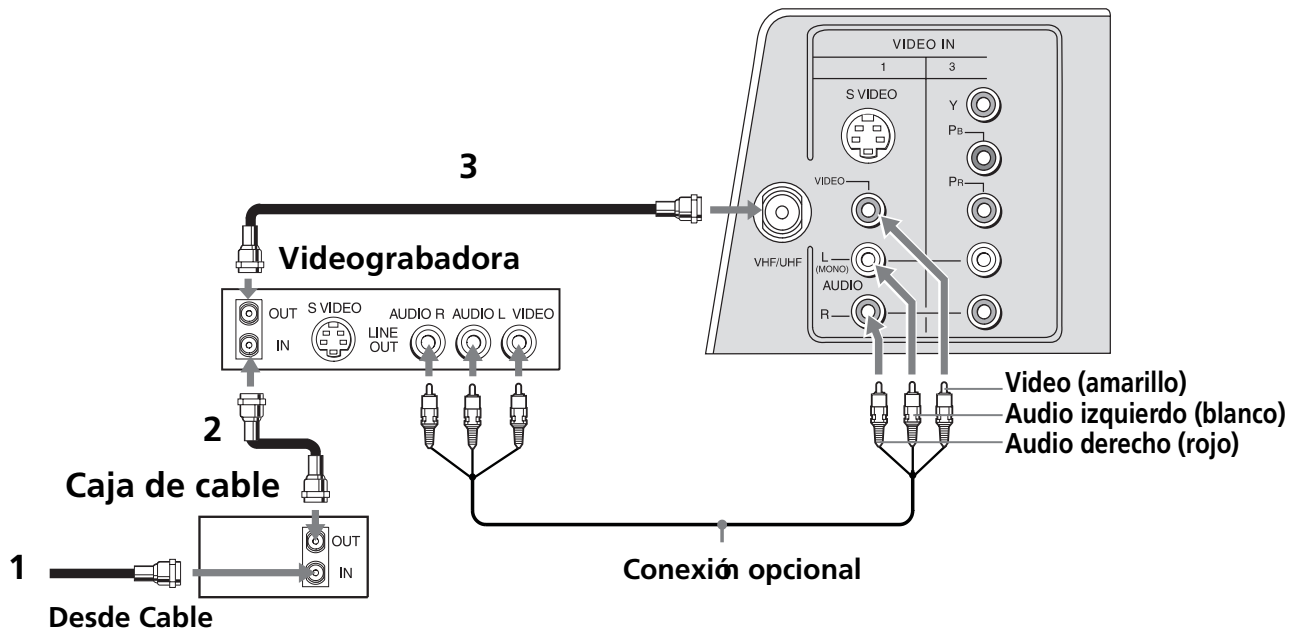

- 1 Conecte el cable coaxial del servicio de cable a la toma IN de la caja de cable.
- 2 Conecte un cable coaxial (no incluido) desde la toma OUT de la caja de cable a la toma IN de la videograbadora.
- 3 Conecte un cable coaxial (no incluido) desde la toma OUT de la videograbadora a la toma VHF/UHF del televisor.

Si desea controlar la selección de todos los canales a través de la caja de cable, es aconsejable utilizar la función Fijar Canal ajustando el televisor en el canal 3 ó 4 (consulte la página 23).

Conexión opcional

- ❑ Si la videograbadora dispone de salidas de video, podrá obtener una mejor calidad de imagen conectando los cables de Audio/Video (no incluidos) desde la salida AUDIO y VIDEO OUT de la videograbadora a la toma de entrada AUDIO/VIDEO IN del televisor.
- ❑ Para obtener una mejor calidad de imagen, utilice S VIDEO en lugar del cable amarillo de audio/video. S VIDEO no proporciona sonido; los cables de audio deben permanecer conectados para obtener sonido.

Puede utilizar el botón para cambiar las entradas VHF/UHF y VIDEO.

Receptor de satélite y el servicio de cable son sistemas de televisión de pago.

Televisor y receptor de satélite

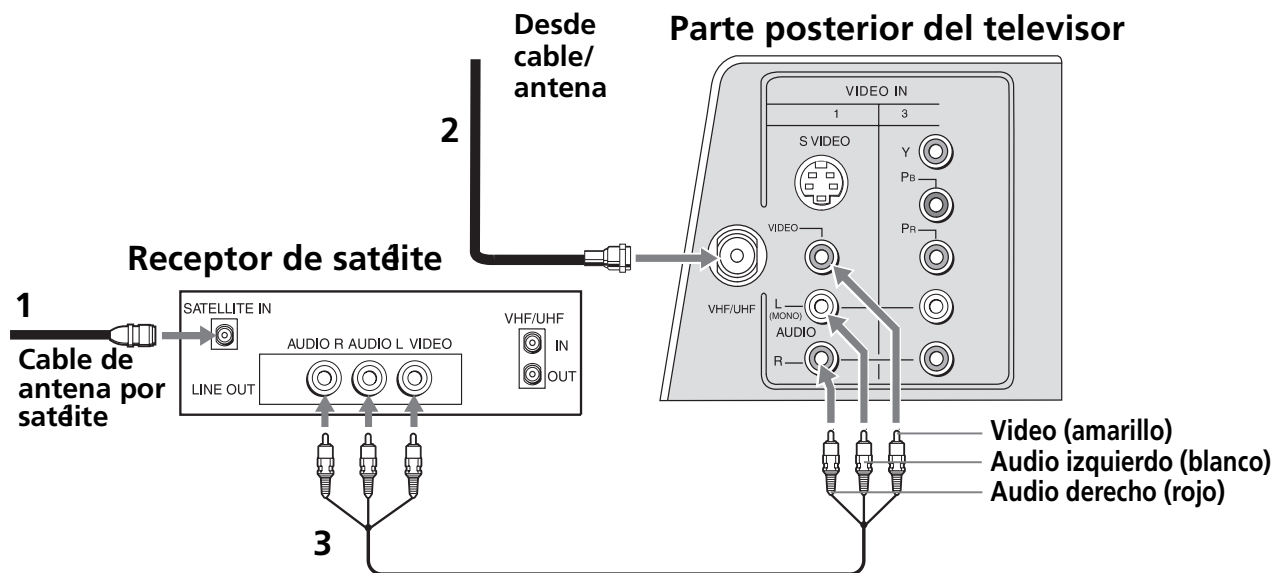

- 1** Conecte el cable de la antena por satélite a la entrada SATELLITE IN del receptor de satélite.
- 2** Conecte el cable coaxial del servicio de cable o antena a la toma VHF/UHF del televisor.
- 3** Utilizar cables de Audio/Video (no incluidos), conecte AUDIO y VIDEO OUT del receptor de satélite a AUDIO y VIDEO IN del televisor.

Para ver programas con el receptor de satélite, sintonice el televisor en el canal 3 o 4.

Puede utilizar el botón para cambiar las entradas VHF/UHF y VIDEO.

Conexión opcional

- Para obtener una mejor calidad de imagen, utilice S VIDEO en lugar del cable amarillo de audio/video. S VIDEO no proporciona sonido; los cables de audio deben permanecer conectados para obtener sonido.

Receptor de satélite y el servicio de cable son sistemas de televisión de pago.

Televisor, receptor de satélite y videogradora

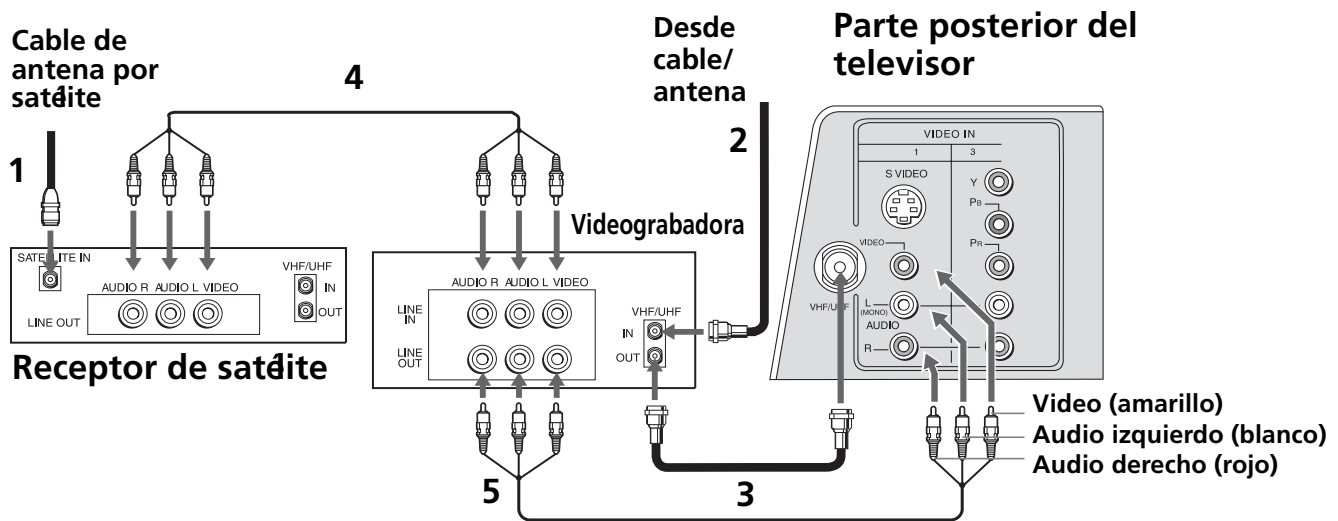

- 1** Conecte el cable de la antena por satélite a la entrada SATELLITE IN del receptor de satélite.
- 2** Conecte el cable coaxial del servicio de cable o antena a la toma IN de la videogradora.
- 3** Conecte la toma OUT de la videogradora a la toma VHF/UHF del televisor mediante un cable coaxial (no incluido).
- 4** Conecte las tomas AUDIO y VIDEO OUT del receptor de satélite a las tomas AUDIO y VIDEO IN de la videogradora mediante los cables de Audio/Video (no incluidos).
- 5** Conecte las tomas AUDIO y VIDEO OUT de la videogradora a las tomas AUDIO y VIDEO IN del televisor mediante los cables de Audio/Video (no incluidos).

Conexión opcional

- ❑ Para visualizar las imágenes desde el receptor del satélite o la videogradora, seleccione la entrada de video a la que está conectado el receptor de satélite o la videogradora oprimiendo **TV/VIDEO** en el control remoto.

Receptor de satélite y el servicio de cable son sistemas de televisión de pago.

Conexión de un reproductor de DVD usando video compuesto (VIDEO/AUDIO L(MONO), R)

Conecte las salidas AUDIO y VIDEO OUT del reproductor de DVD a las entradas AUDIO y VIDEO IN del televisor mediante los cables de AUDIO / VIDEO (no incluidos).

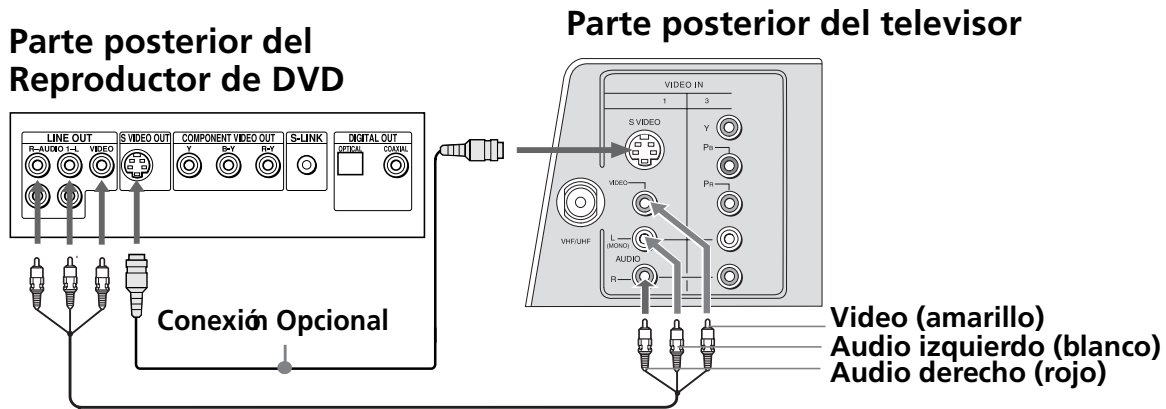

Conexión opcional

- ❑ Para obtener una mejor calidad de imagen, utilice S VIDEO en lugar del cable amarillo de AUDIO/VIDEO. S VIDEO no proporciona sonido; los cables de audio deben permanecer conectados para obtener sonido.

Conexión de un reproductor de DVD usando video componenete (Y, P_B, P_R/L, R)

- ❑ Si el reproductor de DVD dispone de salidas de video para componentes (Y, P_B, P_R), podrá optimizar la calidad de imagen utilizando cables de video para componentes.

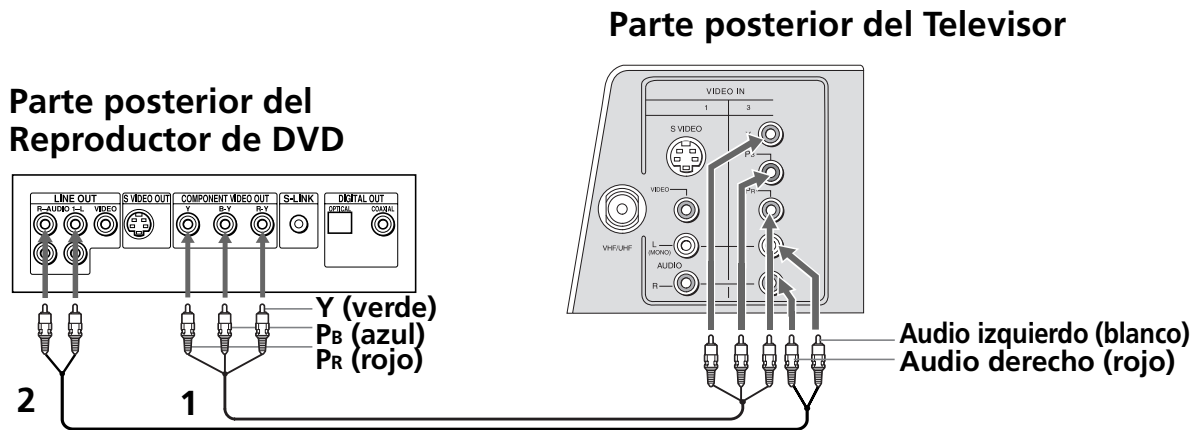

- 1 Conecte las tomas Y, P_B, P_R OUT del reproductor de DVD a las tomas Y, P_B, P_R IN del televisor mediante los cables de video para componentes.
- 2 Conecte la toma AUDIO OUT del reproductor de DVD a la toma AUDIO IN del televisor.

⚠ Las salidas Y, P_B, P_R del reproductor de DVD algunas veces están etiquetadas como Y, P_B y P_R o Y, P_B-Y, y P_R-Y. Si es así, conecte los cables según el color de las tomas.

Conexión de audífonos

Conecte los audífonos a la toma  situada en la parte frontal del televisor.

Panel de Audio/Video frontal

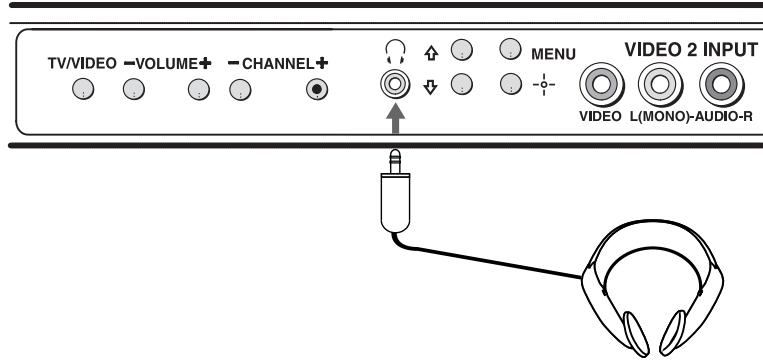

Conexión de una cámara de video

Conecte las salidas AUDIO y VIDEO OUT de la cámara de video a las entradas AUDIO y VIDEO INPUT del televisor mediante los cables de Audio/Video (no incluidos).

Panel de Audio/Video frontal

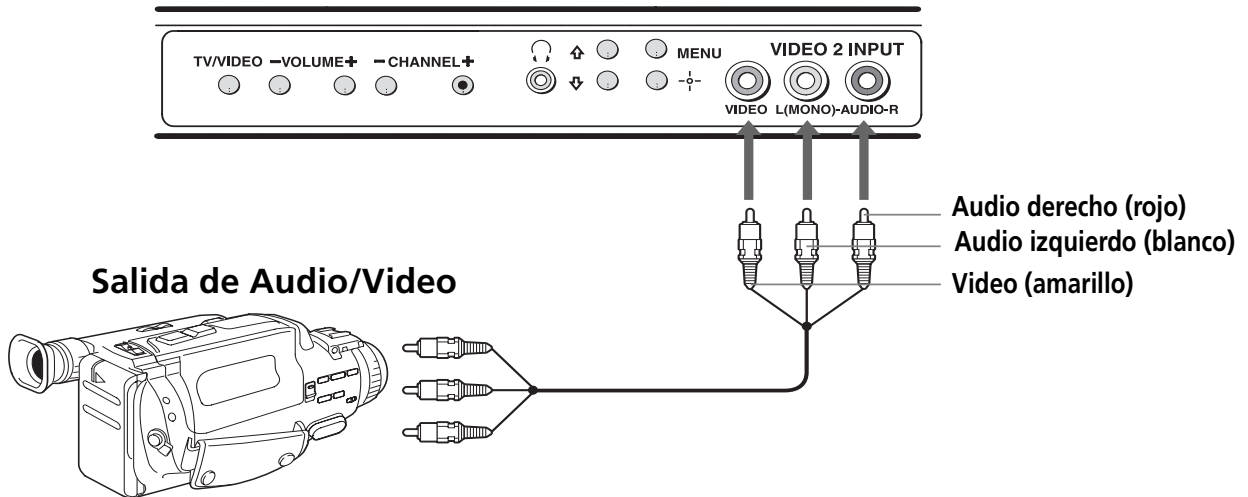

Conexión opcional

- ❑ Para obtener una mejor calidad de imagen, use S VIDEO en lugar del cable amarillo de video. Como S VIDEO no proporciona sonido, debe mantener conectados los cables de audio.

Conexión para editar Videocintas (videograbadora y cámara de video)

Salida de AUDIO/VIDEO

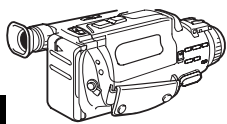

Cámara

Videograbadora



1a

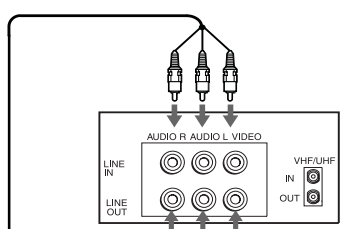

Videograbadora

Parte posterior del Televisor

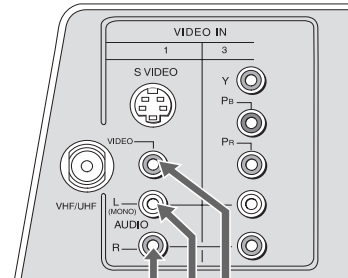

Video (amarillo)
Audio izquierdo (blanco)
Audio derecho (rojo)

2



- 1** Para editar una videocinta conecte a la videograbadora las siguientes aparatos (videograbadora o cámara de video).
 - a)** Con un cable de audio/video (no incluido) conecte AUDIO/VIDEO OUT de la videograbadora (para reproducir) al AUDIO/VIDEO IN de su videograbadora (para grabar).
 - b)** Con un cable de audio/video (no incluido) conecte AUDIO/VIDEO OUT de su cámara de video al AUDIO/VIDEO IN de su videograbadora (para grabar).
- 2** Con un cable de audio/video (no incluido) conecte AUDIO/VIDEO OUT de su videograbadora (para grabar) al AUDIO/VIDEO IN de su televisor.
- 3** Con un cable de audio/video (no incluido) conecte AUDIO/VIDEO OUT de su videograbadora (para grabar) al AUDIO/VIDEO IN de su televisor.

Información Adicional

Solución de problemas

Si tiene problemas con el televisor, intente seguir las indicaciones que se sugieren a continuación. Si el problema persiste, consulte con su proveedor Sony más cercano.

General

Problema	Posibles Soluciones
Hace falta restablecer los ajustes de fábrica	<input type="checkbox"/> Encienda el televisor, mientras mantenga oprimido el botón  del control remoto, oprima el botón de POWER (encendido/apagado) del panel frontal del televisor. (El televisor se apagará). Suelte el botón  . Encienda el televisor.
Aparece un cuadro negro en la pantalla	<input type="checkbox"/> Está seleccionada una opción de texto en el menú de Ajustes (página 27) y no hay texto disponible. Para desactivar esta función, seleccione No en la opción Caption Vision (subtítulos). Si desea ver subtítulos, escoja CC1-4 en lugar de Text1-4.

Control Remoto

El Control Remoto no funciona	<input type="checkbox"/> Al operar su televisor oprima TV (FUNCTION). <input type="checkbox"/> Vea si coloco las baterías correctamente. <input type="checkbox"/> Las baterías pueden estar bajas. Sustitúyalas (página 2). <input type="checkbox"/> Aleje el televisor a 1 metro aproximadamente de cualquier lámpara fluorescente.
No se puede cambiar el canal con el control remoto	<input type="checkbox"/> Asegúrese de que no ha cambiado el televisor del canal 3 o 4 con otro dispositivo para cambiar canales.
Perdió el control remoto	<input type="checkbox"/> Puede utilizar los botones del panel frontal de audio y video para acceder a los menús (página 2). Póngase en contacto con su proveedor Sony mas cercano para solicitar uno de repuesto.

Video

No hay imagen ni sonido	<input type="checkbox"/> Asegúrese de que el cable de alimentación esté conectado <input type="checkbox"/> Si hay luz roja que parpadea en la parte frontal del televisor durante unos minutos, desconecte y vuelva a conectar el cable de alimentación para restaurar el televisor. Si el problema persiste llame al servicio técnico local. <input type="checkbox"/> Compruebe los ajuste de TV/VIDEO; si ve la televisión, póngalo en TV; si ve imágenes de un aparato de video, póngalo en VIDEO 1,2,3 o 4 (página 3). <input type="checkbox"/> Intente ver otro canal para descartar algún problema en la emisora.
Imagen de mala calidad, sin imagen, buen sonido	<input type="checkbox"/> Ajuste el contraste en el menú de Video (página 20). <input type="checkbox"/> Ajuste el brillo en el menú de Video (página 20). <input type="checkbox"/> Compruebe las conexiones de la antena o del cable (página 6).

Imagen pobre en color y nitidez	<input type="checkbox"/> Ajuste color en el menú de video (página 20). <input type="checkbox"/> Ajuste nitidez en el menú de video (página 20). <input type="checkbox"/> Asegúrese en el menú de video que la opción de "Intelligent Pic" se encuentre en la posición de "No" (página 21).
--	---

Sin color	<input type="checkbox"/> Ajuste Color en el menú de Video (página 20).
------------------	--

Sin señal	<input type="checkbox"/> Compruebe el ajuste de Cable en el menú de Canal (página 23). <input type="checkbox"/> Compruebe las conexiones de la antena o del cable (página 6). <input type="checkbox"/> Asegúrese de que el canal seleccionado esté emitiendo señal.
------------------	---

Líneas de puntos o rayas	<input type="checkbox"/> Ajuste la antena. <input type="checkbox"/> Aparte el televisor de cualquier otro equipo electrónico. Algunos equipos electrónicos crean ruido eléctrico que puede interferir con la recepción del televisor.
---------------------------------	--

Imágenes dobles o fantasmas	<input type="checkbox"/> Revise la antena exterior a llame al servicio técnico de cable.
------------------------------------	--

Audio

Buena imagen, sin sonido	<input type="checkbox"/> Presione ^{MUTING}  para que desaparezca Muting de la pantalla (página 3) <input type="checkbox"/> Compruebe los ajustes de Audio. Es posible que el televisor esté ajustado en Auto SAP o se encuentre en la posición No (página 22).
---------------------------------	---

Canales

No se reciben canales con un número alto (UHF) cuando se utiliza una antena	<input type="checkbox"/> Asegúrese de que Cable esté en la posición NO en el menú de Canal (página 23). <input type="checkbox"/> Ejecute autoprogramación para añadir canales que actualmente no estén en la memoria (página 15).
--	--

Parece que no funcionan las emisoras de cable	<input type="checkbox"/> Asegúrese de que Cable esté en la posición Si en el menú de Canal (página 23). <input type="checkbox"/> Ejecute Auto programación para añadir canales que actualmente no estén en la memoria (página 15).
--	---

Sólo se puede sintonizar la señal de televisión en la ventanilla	<input type="checkbox"/> Asegúrese de que no configuró la etiqueta de video en el menú de Ajustes (página 27) para omitir sus entradas de video.
---	--

Si después de leer este manual de instrucciones, tiene más preguntas relacionadas con el uso del televisor Sony, póngase en contacto con su proveedor Sony más cercano para recibir asistencia técnica.