

Trinitron® Color TV

Operating Instructions

KV-13M10
KV-MT1300
KV-14R10
KV-14R10C
KV-1460R
KV-20M10
KV-20S10
KV-20S11
KV-MT2000
KV-ST2050
KV-21R10
KV-21R10C
KV-21RS10
KV-21RS10C
KV-2180R
KV-2190RS

Warning

To prevent fire or shock hazard, do not expose the television to rain or moisture.

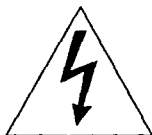
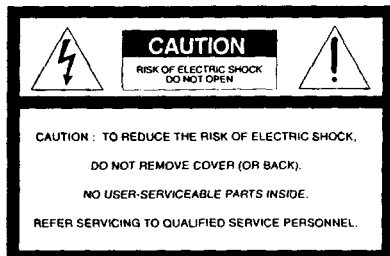

This symbol is intended to alert the user to the presence of uninsulated "dangerous voltage" within the product's enclosure that may be of sufficient magnitude to constitute a risk of electric shock to persons.



This symbol is intended to alert the user to the presence of important operating and maintenance (servicing) instructions in the literature accompanying the appliance.

Safety precautions

- Operate the TV only on 120 V AC, 60 Hz except KV-14R10C, KV-21R10C, KV-21RS10C which are 220 V AC, 60 Hz.
- One blade of the plug is wider than the other for safety purposes and will fit into the power outlet only one way. If you are unable to insert the plug fully into the outlet, contact your dealer. Except KV-14R10C, 21R10C, 21RS10C.
- To prevent electric shock, do not use this polarized AC plug with an extension cord, receptacle or other outlet unless the blades can be fully inserted to prevent blade exposure.

For details concerning safety precautions, see the attaching leaflet "IMPORTANT SAFEGUARDS."

CAUTION

When using TV games, computers, and similar products with your TV, keep the brightness and contrast functions at low settings. If a fixed (non-moving) pattern is left on the screen for long periods of time at a high brightness or contrast setting, the image can be permanently imprinted onto the screen. These types of imprints are not covered by your warranty because they are the result of misuse.

Note on Caption Vision (USA and Canadian models only)

This television receiver provides display of television closed captioning in accordance with § 15.119 of the FCC rules.

Note to CATV system installer

This reminder is provided to call the CATV system installer's attention to Article 820 - 40 of the NEC that provides guidelines for proper grounding and, in particular specifies that the cable ground shall be connected to the grounding system of the building, as close to the point of cable entry as practical.

Owner's Record

The model and serial numbers are located at the rear of the TV. Record these numbers in the spaces provided below. Refer to them whenever you call upon your Sony dealer regarding this product.

Model No. _____

Serial No. _____

Table of contents

Welcome! 5

Setting Up

Connections 6
 Connecting to outdoor antenna 6
 Connecting to indoor antenna 7
 Connecting to cable TV system 7
 Connecting to a VCR 8
Setting up the remote commander 9
Setting cable TV on or off 10
Presetting channels 12

Available Features

Functions 14
Setting the language preference 16
Adjusting the picture 17
Displaying Caption Vision 19
Specifying stereo or bilingual programs (MTS) 20
Customizing the channel number buttons 21
Listening with headphones 22

Additional Information

Troubleshooting 23
Specifications back cover

Welcome!

Thank you for purchasing the Sony Trinitron Color TV. Before operating the TV, please read this manual thoroughly and retain it for future reference.

The instructions in this manual are for the models listed on the front cover. Before you start reading, check your model number by looking at the rear of your TV. The KV-2190RS is the model used for illustration purposes. Any differences in operation are clearly indicated in the text, for example, "*KV-2190RS only.*"

Here are some of the features you will enjoy with your TV:

- A 181-channel frequency synthesis tuner.
- On-screen menus that let you set the picture quality, sound, and other settings.
- A sleep timer that automatically turns off the TV after the time you selected.
- An Audio/Video input jack to connect your VCR to the TV (*KV-13M10/14R10/14R10C/20M10/20S10/20S11/21R10/21R10C/21RS10/21RS10C only*).
- A dual language feature that lets you choose the menu language either in English or Spanish (*KV-14R10/14R10C/1460R/21R10/21R10C/21RS10/21RS10C/2180R/2190RS only*).

Connections

Select one of the three ways to connect the TV to the antenna and/or cable system. It is recommended to connect an outdoor antenna or a cable TV system for better picture quality.

Connecting to outdoor antenna

Connect the antenna cable to the VHF-UHF antenna terminal. If the antenna cable cannot be connected directly to the jack, follow one of the diagrams below, depending on the type of cable you have.

Notes

- Do not use tools to attach the cable to the VHF/UHF terminal. Doing so may damage the terminal.
- Most VHF/UHF combination antennas have a signal splitter. Remove the splitter before attaching the appropriate connector.
- If the U/V mixer is used, snow and noise may appear in the picture when viewing cable TV channels over 37.

A

- VHF only
or
• VHF/UHF

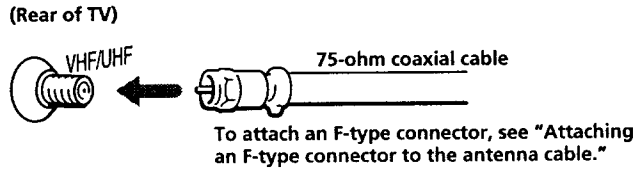

B

- VHF only
or
• UHF only
or
• VHF/UHF

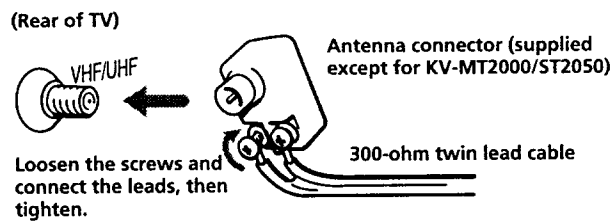

C

- VHF
and
• UHF

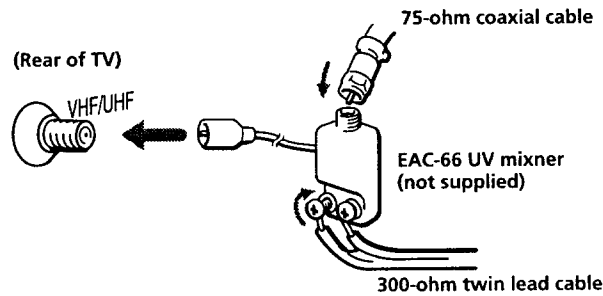

Attaching an F-type connector to the antenna cable

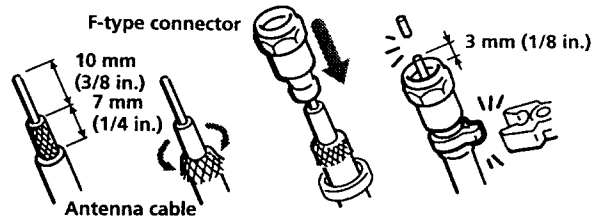

Connecting to indoor antenna

■ Except for KV-MT2000/ST2050

Use the supplied dipole antenna and antenna connector. To attach the antenna connector, see "Connecting to outdoor antenna **B**." After you've turned on the TV, adjust the antenna for best reception.

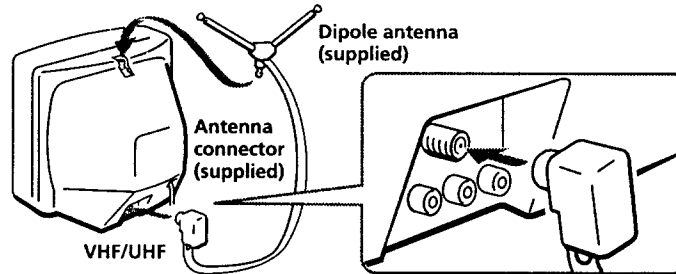

Connecting to cable TV system

If your cable company requires you to connect a cable box, follow example **A**. If not, follow example **B**.

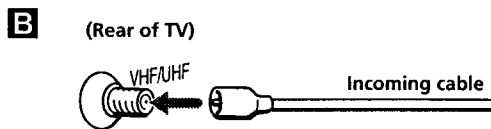
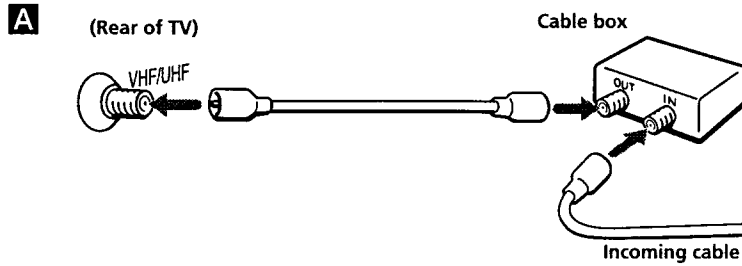

Connecting to a VCR

To connect the VCR to the TV, first check the model number of the TV and select the appropriate connection diagram below. For details on connection, see the instruction manual of the VCR. Before making the connection, disconnect the AC power cords of equipment being used.

■ For KV-20S10/20S11/21RS10/21RS10C

(Rear of TV)

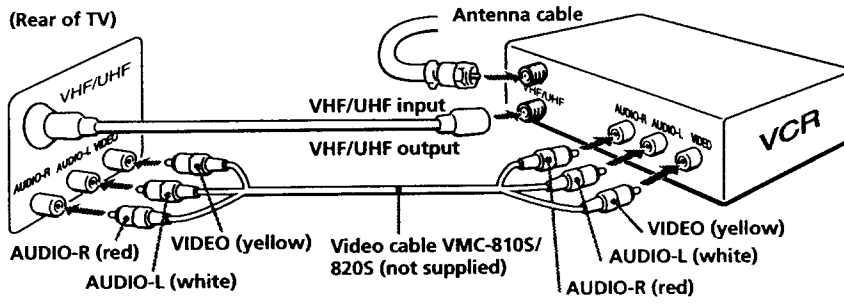

■ For KV-13M10/14R10/14R10C/20M10/21R10/21R10C

(Rear of TV)

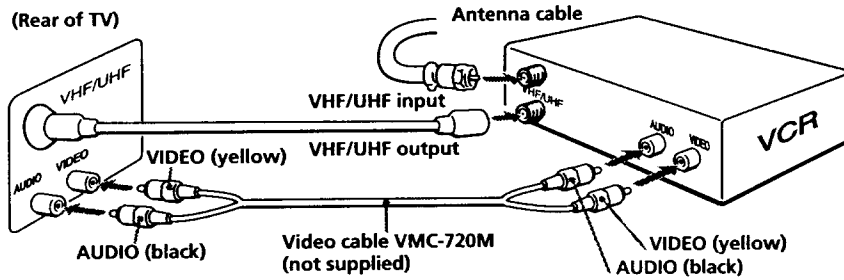

To watch video tapes

Press the TV/VIDEO button until "VIDEO" appears on the screen.

■ For KV-MT1300/1460R/MT2000/ST2050/2180R/2190RS

(Rear of TV)

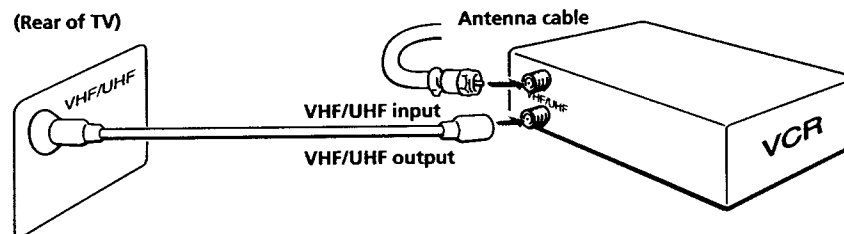

To watch video tapes

- 1 On the TV: Preset channel 3 or 4, whichever is not used in your area, following the instructions for adding channels in "Presetting channels" (page 13).
- 2 On the VCR: Set the channel to the same channel as chosen above. Then begin viewing the video tape.

Setting up the remote commander

Install two size AA batteries (supplied) as shown.

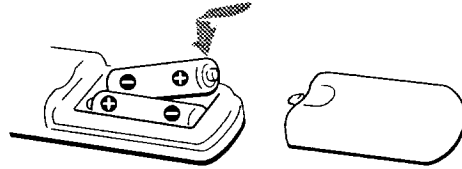

Notes

- Match the + and - on the batteries to the diagram inside the battery compartment.
- If you do not use the remote commander for an extended period of time, remove the batteries to avoid possible damage from battery leakage.
- Do not handle the remote commander roughly. Do not drop it, step on it or let it get wet.
- Do not place the remote commander in direct sunlight, near a heater, or where the humidity is high.

Instructions in this manual are based on the remote commander. You can also use the controls on the TV if they have the same name as those on the remote commander.

(KV-14R10/14R10C/1460R/21R10/21R10C/21RS10/21RS10C/2180R/2190RS only)

If you prefer your menus in Spanish, see page 16 for instructions.

Setting cable TV on or off

If the TV is connected to a cable TV system, then the factory setting CABLE ON is correct. If the TV is not connected, set CABLE to OFF.

Note

If more than 90 seconds elapse after you press a button, the menu disappears automatically.

- 1 Press MENU.
The main menu appears.

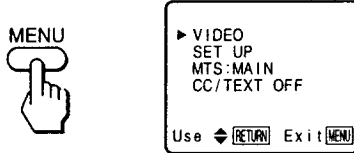

- 2 Press $\Delta+$ or $\nabla-$ on the remote commander to move the cursor (\blacktriangleright) on the screen to SET UP. To select that function, press RETURN.
The SET UP menu appears.

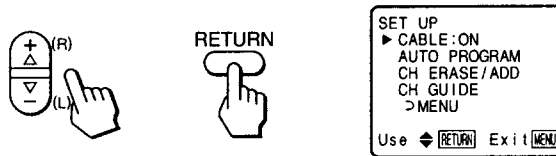

Note

If CABLE appears in black, the TV is set to video input and CABLE cannot be selected. Press TV/VIDEO so that a channel number appears.

- 3 Set CABLE to ON or OFF.

(1) If the cursor is not beside CABLE, press $\Delta+$ or $\nabla-$ to move the cursor and press RETURN.



(2) Press $\Delta+$ or $\nabla-$, to select ON or OFF.

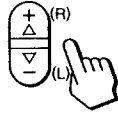

(3) Press RETURN.

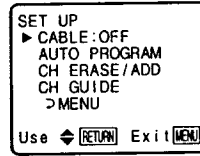

4 Press MENU to return to the original screen.



Presetting channels

TV channels can be preset easily: first store all the receivable channels automatically, following the procedure below. Next, erase unwanted channels or add additional channels. Preset channels during the day rather than late at night, when some channels may not be broadcasting.

1 Press MENU.

2 Press $\Delta+$ or $\nabla-$ on the remote commander to move the cursor (\blacktriangleright) on the screen to SET UP and press RETURN.
The SET UP menu appears.

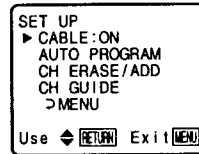
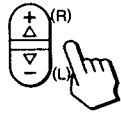

Note

If AUTO PROGRAM appears in black, the TV is set to video input and AUTO PROGRAM cannot be selected. Press TV/VIDEO so that a channel number appears.

3 Select AUTO PROGRAM.

(1) Press $\Delta+$ or $\nabla-$ to move the cursor (\blacktriangleright) to AUTO PROGRAM.

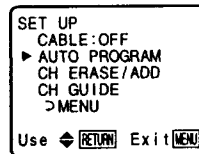
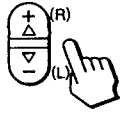

(2) Press RETURN.



"AUTO PROGRAM" appears on the screen and the TV starts scanning and presetting channels automatically. When all the receivable channels are stored, "AUTO PROGRAM" disappears and the lowest numbered channel is displayed.

Erasing or adding channels

- 1 Press MENU.
- 2 Press $\Delta+$ or $\nabla-$ to select SET UP and press RETURN.
- 3 Press $\Delta+$ or $\nabla-$ to select CH ERASE/ADD and press RETURN.
- 4 To erase an unwanted channel:
 - (1) Press CH +/- to select the channel you want to erase.
 - (2) Make sure the cursor (\blacktriangleright) is beside ERASE.

Channel to be erased

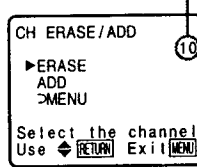

- (3) Press RETURN.
The indication "-" appears beside the channel number, showing that the channel is erased from the preset memory.

To add a channel that you want:

- (1) Press 0-9 buttons to select the channel you want to add and press ENTER.
- (2) Press $\Delta+$ or $\nabla-$ to select ADD.

Channel to be added

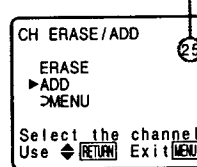

- (3) Press RETURN.
The indication "+" appears beside the channel number, showing that the channel is added to the preset memory.

- 5 To erase and/or add other channels, repeat step 4.
- 6 When finished, press MENU.

Note

If you erase or add a VHF or UHF channel, the cable TV channel with the same number is also erased or added, and vice versa.

Functions

Note

If "VIDEO" appears on the screen, press TV/VIDEO so that a channel number appears.

Selecting a channel directly

Press the 0-9 buttons to select a channel. Or press ENTER after entering the channel for immediate selection.



To scan through channels

Press CH +/- until the channel you want appears.

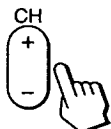

Switching quickly between two channels

Press JUMP.

The channel you watched previously appears. Pressing JUMP again switches back to the previous channel.



Adjusting the volume

Press VOL +/- to adjust the volume.

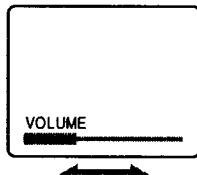
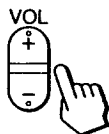

Muting the sound

Press MUTING.
"MUTING" appears on the screen.



To restore the sound, press MUTING again, or press VOL +.

Displaying on-screen information

Use this feature to check your channels and MTS mode.
Press DISPLAY.



To cancel the display, press DISPLAY again.

Setting the Sleep Timer

The TV stays on for the length of time specified and then shuts off automatically.
Press SLEEP repeatedly until the time (minutes) wanted appears. Each time you press SLEEP, the time changes as follows: 30 → 60 → 90 → OFF.



To cancel the Sleep Timer, press SLEEP repeatedly until "SLEEP OFF" appears, or turn the TV off.

Note

If DISPLAY or MUTING is pressed with Caption Vision selected, the channel or muting display will disappear after a few seconds.

Setting the language preference

■ For models KV-14R10/14R10CI/1460R/21R10/21R10CI/21RS10/21RS10CI/2180R/2190RS

If Spanish is preferred to English, the menu language can be changed.

- 1 Press MENU.
- 2 Press $\Delta+$ or $\nabla-$ to move the cursor (\blacktriangleright) to ENGLISH and press RETURN.

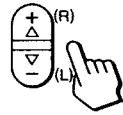

- 3 Press $\Delta+$ or $\nabla-$ to select ESPAÑOL and press RETURN.

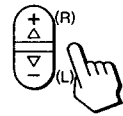

- 4 Press MENU to return to the normal screen.



Adjusting the picture

When watching TV programs, the quality of the picture can be adjusted to suit your taste.

- 1 Press MENU.
- 2 Make sure the cursor (▶) is beside VIDEO and press RETURN.

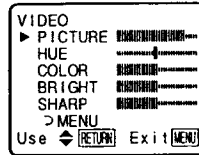

- 3 Select the item to adjust. See chart on following page for details on results of adjustments. For example:
To adjust brightness, press Δ+ or ▽- to select BRIGHT and press RETURN.

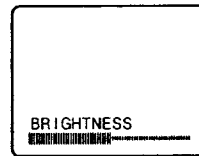
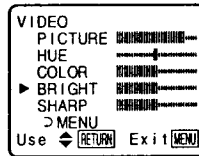
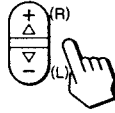

- 4 Adjust the selected item:
(1) Press Δ+ or ▽- to adjust the item.

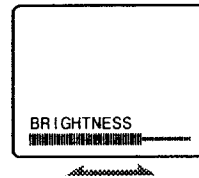
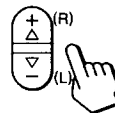

- (2) Press RETURN.
The new setting appears in the VIDEO menu.

- 5 To adjust other items, repeat steps 3 and 4 above.

(continue)

Description of adjustable items

Item	Adjustment	
	Press $\Delta+$ to	Press $\nabla-$ to
PICTURE	Increase picture contrast for vivid color	Decrease picture contrast for soft color
HUE	Make skin tones become greenish	Make skin tones become purplish
COLOR	Increase color intensity	Decrease color intensity
BRIGHT	Brighten the picture	Darken the picture
SHARP	Sharpen the picture	Soften the picture

To restore the factory settings

Press RESET while the VIDEO menu is displayed. All the settings except PICTURE are restored to factory settings.

Displaying Caption Vision

■ USA and Canadian models only

Some programs are broadcast with Caption Vision. To display Caption Vision, select either CC1, CC2, TEXT1, or TEXT2 from the menu. CC1 or CC2 shows you a caption, that is a printed version of the dialog or sound effects of a program. (The mode should be set to CC1 for most programs.) TEXT1 or TEXT2 shows you text, that is information presented using half of the screen. It is not usually related to the program.

1 Press MENU.

2 Press $\Delta+$ or $\nabla-$ to select **CC** /TEXT and press RETURN.

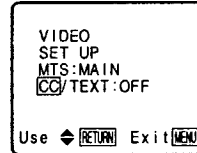

3 Press $\Delta+$ or $\nabla-$ to select the caption type and press RETURN.

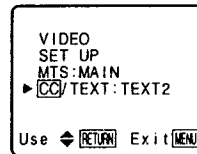
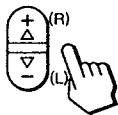

Notes

- Captions disappear for a few seconds when you press the DISPLAY or MUTING button.
- Captions may appear with a white box or other errors instead of a certain word. Poor reception of TV programs can also cause errors in captions.

Specifying stereo or bilingual programs (MTS)

■ For models KV-20S10/20S11/ST2050/21RS10/21RS10C/2190RS

The Multichannel TV Sound (MTS) feature allows you to enjoy stereo sound (MAIN) or Second Audio Programs (SAP) at your choice. The initial setting is stereo sound (MAIN).

- 1 Press MENU.
- 2 Make sure the cursor (▶) is beside MTS and press RETURN.

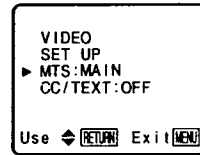

- 3 Press Δ+ or ▽- to select MAIN, SAP, or MONO and press RETURN.

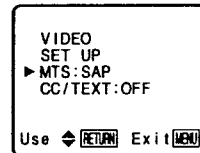
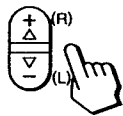

MTS mode	Sound source
MAIN	Listen to stereo sound.
SAP	Listen to bilingual programs. The sound of non-SAP programs will be muted when SAP is selected.
MONO	Reduce noise during stereo broadcasts.

Customizing the channel number buttons

Up to 12 channels can be assigned to a specific channel number. This feature allows the easy selection of your favorite channels using the on-screen menu. For example, channel number button 2 can be assigned to channel 124.

Assigning a channel number button to a favorite channel

- 1 Press MENU.
- 2 Press $\Delta+$ or $\nabla-$ to select SET UP and press RETURN.
- 3 Press $\Delta+$ or $\nabla-$ to select CH GUIDE and press RETURN.

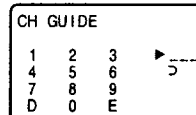

- 4 Press RETURN again.

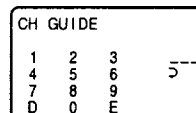

- 5 Press $\Delta+$ or $\nabla-$ to select a customized channel number (chosen number will appear in red) and press RETURN.
Numbers 0-9 and DISPLAY and ENTER are available for use as a customized channel number. DISPLAY and ENTER are shown as D and E respectively on the screen. The channel number button selected will be the one you press to call up your favorite channel.

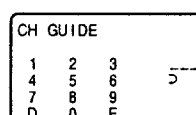
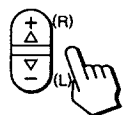

- 6 Press $\Delta+$ or $\nabla-$ to select the channel and press RETURN.

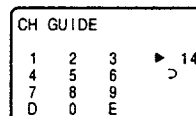
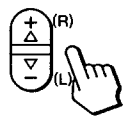

- 7 Repeat steps 5 and 6 to set other channels.

To cancel a setting

Select the channel you want to cancel in step 5, then press RESET.

Using the customized channel number buttons

- 1 Press CH GUIDE.
The CHANNEL GUIDE menu appears showing channel number buttons and the corresponding channels.
- 2 Press a channel number button, DISPLAY or ENTER on the commander to select the channel you want.

To cancel the CHANNEL GUIDE menu

Press CH GUIDE while the CHANNEL GUIDE menu is displayed.

Listening with headphones

■ For models KV-13M10/14R10/14R10C/20M10/20S10/20S11/21R10/21R10C/21RS10/21RS10C/21M10

Plug the headphones into the headphones jack.

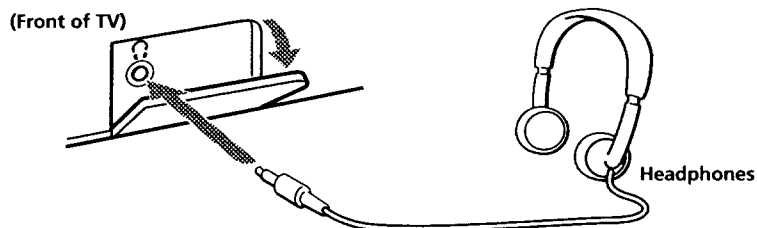

Notes

- To prevent hearing damage due to sudden or prolonged excessive volume, do not raise the headphones volume too high while listening.
- Using the headphones jack will turn off the sound to TV speakers.
- If your TV is a monaural TV, the monaural sound will be heard from both headphones.

Specifications

■ For all models

Television system
American TV standard
Channel coverage
VHF: 2-13/UHF: 14-69/CATV: 1-125
Antenna
75-ohm external antenna terminal for
VHF/UHF
Picture tube
Trinitron® tube
Power requirements
120 V, 60 Hz except KV-14R10C/
21R10C/21RS10C are 220 V, 60Hz

■ KV-13M10/MT1300/14R10/14R10C/ 1460R

Screen size
13 in.
Inputs
1 video, 1 audio (KV-13M10/14R10/
14R10C only)
Speaker output
1 W
Power consumption
75 W when in use
4 W in standby
6 W in standby (KV-14R10C only)
Dimensions (W/H/D)
372 × 339 × 408 mm
(14³/₄ × 13³/₈ × 16¹/₈ in.)
Mass
10.3 kg (22 lb 12 oz)
Supplied accessories
Size AA batteries (2)
Dipole antenna (1)
Antenna connector (1)
KV-13M10/14R10/14R10C: Remote
commander
RM-Y116 (1)
KV-MT1300: Remote commander
RM-Y123 (1)
KV-1460R: Remote commander
RM-Y123 (1)

■ KV-20M10/MT2000/21R10/21R10C/ 2180R

Screen size
20 in.
Inputs
1 video, 1 audio (KV-20M10/21R10/
21R10C only)
Speaker output
2 W

Power consumption
97 W when in use
4 W in standby
6 W in standby (KV-21R10C only)
Dimensions (W/H/D)
KV-20M10/21R10/21R10C: 522 × 475 ×
471.2 mm (20⁵/₈ × 18³/₄ × 18⁵/₈ in.)
KV-MT2000/2180R: 526 × 488 ×
477.5 mm (20³/₄ × 19¹/₄ × 18⁷/₈ in.)

Mass
21.7 kg (47 lb 14 oz)
Supplied accessories
Size AA batteries (2)
KV-20M10/21R10/21R10C: Remote
commander RM-Y116 (1), Dipole
antenna (1), Antenna connector (1)
KV-MT2000: Remote commander
RM-Y123 (1)
KV-2180R: Remote commander
RM-Y123 (1), Dipole antenna (1),
Antenna connector (1)

■ KV-20S10/20S11/ST2050/21RS10/ 21RS10C/2190RS

Screen size
20 in.
Inputs
1 video, 2 audio (KV-20S10/20S11/
21RS10/21RS10C only)
Speaker output
2 W + 2 W
Power consumption
100 W when in use
4 W in standby
6 W in standby (KV-21RS10C only)
Dimensions (W/H/D)
KV-20S10/20S11/21RS10/21RS10C: 522×
475 × 471.2 mm (20⁵/₈ × 18³/₄ × 18⁵/₈ in.)
KV-ST2050/2190RS: 526 × 488 × 477.5
mm (20³/₄ × 19¹/₄ × 18⁷/₈ in.)
Mass
21.8 kg (48 lb 10 oz)
Supplied accessories
Size AA batteries (2)
KV-20S10/20S11/21RS10/
21RS10C: Remote commander RM-
Y116 (1), Dipole antenna (1), Antenna
connector (1)
KV-ST2050: Remote commander
RM-Y123 (1)
KV-2190RS: Remote commander
RM-Y123 (1), Dipole antenna (1),
Antenna connector (1)

Design and specifications are subject to
change without notice.

Troubleshooting

After trying the remedies below and the problem is not corrected, contact your nearest Sony dealer.

Problem	Adjustment
Poor or no picture (screen lit), good sound	<ul style="list-style-type: none"> • Adjust PICTURE in the VIDEO menu. • Adjust BRIGHT in the VIDEO menu. • Check antenna/cable connections.
Good picture, no sound.	<ul style="list-style-type: none"> • Check the MTS setting in the AUDIO menu.
No picture (screen not lit), no sound	<ul style="list-style-type: none"> • Make sure the power cord is connected securely. • Check to see if the TV/VIDEO setting is correct: when watching TV, set to TV, and when watching video tapes, set to VIDEO or the channel you use for watching video. • Try another channel. It could be station trouble.
No color	<ul style="list-style-type: none"> • Adjust COLOR in the VIDEO menu. • Black and white programs cannot be seen in color.
Only snow and noise appear on the screen	<ul style="list-style-type: none"> • Check the CABLE setting in the SET UP menu. • Check the antenna/cable connection. • Make sure the channel is broadcasting programs.
Dotted lines or stripes	<ul style="list-style-type: none"> • Adjust the antenna. • Move the TV away from noise sources such as cars, neon signs, and hair-dryers.
Double images or ghosts	<ul style="list-style-type: none"> • Use a highly directional outdoor antenna or a cable TV cable (when the problem is caused by reflections from nearby mountains or tall buildings).
Cannot operate menu	<ul style="list-style-type: none"> • The menu disappears automatically when 90 seconds elapse after you press a button. • If the menu items appear in black, the TV is set to video input and you cannot operate the menu. Press TV/VIDEO until a channel number appears.
The remote commander does not operate	<ul style="list-style-type: none"> • Insert the batteries in the remote commander with the correct polarity. • Replace the batteries with new ones if they are weak. • If there is a fluorescent light close to the TV, move it at least 3-4 feet away from the TV.
The TV needs to be cleaned.	<ul style="list-style-type: none"> • Clean the TV with a soft dry cloth. Never use strong solvents such as thinner or benzine, which might damage the finish of the cabinet.